



San Francisco Refinery

Rodeo, California

BAAQMD Plant 16

Flare Minimization Plan (FMP)

Non Confidential version

Bay Area Air Quality Management District (BAAQMD)

Regulation 12, Rule 12

October 2011, Revision 7

Contents

1.0 Flare Minimization Plan	1-3
1.1 Safety Statement	1-3
1.2 Executive Summary	1-3
1.3 Certification	1-5
2.0 Flare System Information	2-1
2.1 Background Information for Flare Systems	2-1
2.2 Technical Data – Description of Flaring Systems (401.1).....	2-3
2.2.1 ConocoPhillips, San Francisco Refinery Flare & Fuel Gas Recovery System Overview	2-3
2.2.2 Detailed process flow diagram, PFD (401.1.1).....	2-3
2.2.3 Description of Monitoring and Control Equipment (401.1.2).....	2-4
3.0 Reductions & Planned Reductions.....	3-1
3.1 Reductions Previously Realized (401.2)	3-1
3.2 Planned Reductions (401.3)	3-15
4.0 Prevention Measures (401.4)	4-1
4.1 “Major” Maintenance Activities (401.4.1)	4-1
4.1.1 Refinery Maintenance and Turnaround Activities.....	4-1
4.1.2 Measures to Minimize Flaring During Preplanned Maintenance	4-9
4.1.3 Turnaround and Maintenance Flare Minimization Planning Tool	4-16
4.1.4 Measures to Minimize Flaring During Unplanned Maintenance	4-16
4.2 Gas Quality/Quantity Issues for Each Flare (401.4.2)	4-17
4.2.1 When Flaring is Likely to Occur	4-17
4.2.2 Vent Gas Recovery Systems	4-21
4.3 Recurrent failure (401.4.3)	4-27
4.3.1 Reportable Flaring Events Attributable to the Same Process or Equipment Item	4-27
4.3.2 Means to Prevent Recurrent Failure	4-27
5.0 Other Information Requested by APCO to Assure Compliance (401.5).....	5-1
5.1 New Equipment Installations (404.2).....	5-1

Attachments

Attachment A	San Francisco Refinery Simplified Flare System Overview
Attachment B	San Francisco Refinery Detailed Flare Gas System Description
Attachment C	San Francisco Refinery Flare System Process Flow Diagram
Attachment D	Historical Startup / Shutdown Event Data (2000 – 2006) BUSINESS CONFIDENTIAL
Attachment E	San Francisco Refinery Unit List
Attachment F	Flare Minimization Process Flowchart
Attachment G	Typical Flare Gas Recovery System
Attachment H	Flaring Event Overview, Recurring Failure Review, and Categorization (2004 – 2010)
Attachment I	Storage, Treatment, & Recovery Schematic
Attachment J	<i>DELETED – previous Attachment J now included in Attachment H</i>
Attachment K	Flare Construction BUSINESS CONFIDENTIAL portion
Attachment L	Compressor Capacity & Monitoring Description BUSINESS CONFIDENTIAL portion
Attachment M	Fuel Gas System Description BUSINESS CONFIDENTIAL portion
Attachment N	Cost Effectiveness Calculation Background Material

1.0 Flare Minimization Plan

Regulation 12, Rule 12, was adopted by the BAAQMD in July, 2005, with the objective of reducing emissions from flares at petroleum refineries. This flare minimization plan for the [ConocoPhillips, San Francisco Refinery \(SFR\) located in Rodeo, CA](#) is consistent with progress toward that goal. It defines a series of measures that will lead to minimization of flaring without compromising refinery operations and practices with regard to safety. The key tools utilized are careful planning to minimize flaring, measuring and monitoring of flare events when they occur, coupled with evaluation of the cause of flaring events that do occur. Using this approach, an understanding of the events leading to the flaring event can then be incorporated into future planning and flare minimization efforts. The plan also examines the costs and benefits of potential equipment modifications to further increase flare gas recovery.

1.1 Safety Statement

This Flare Minimization plan outlines the approach that [ConocoPhillips, San Francisco Refinery](#) has developed to manage and minimize flaring events, without compromising the critical safety function of the flare system. Flares are first and foremost devices to ensure the safety of refinery operations and personnel. Nothing in the BAAQMD 12-12 rule or in this Flare Minimization Plan (FMP) should be construed to compromise refinery operations and practices with regards to safety.

1.2 Executive Summary

Shown below are graphical representations of historical flare flow and emissions from the period of 2004 to June 30, 2011:

COP Rodeo Refinery- Flare Flow

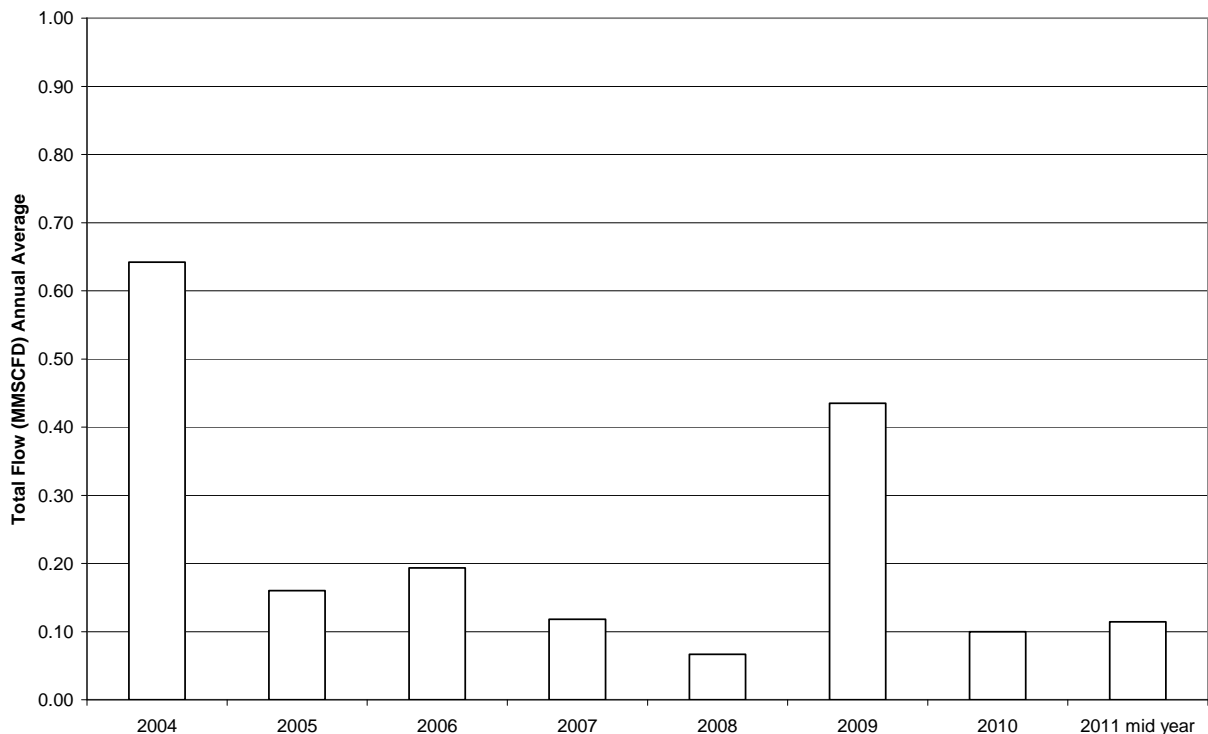

COP Rodeo Refinery - Flare Emissions

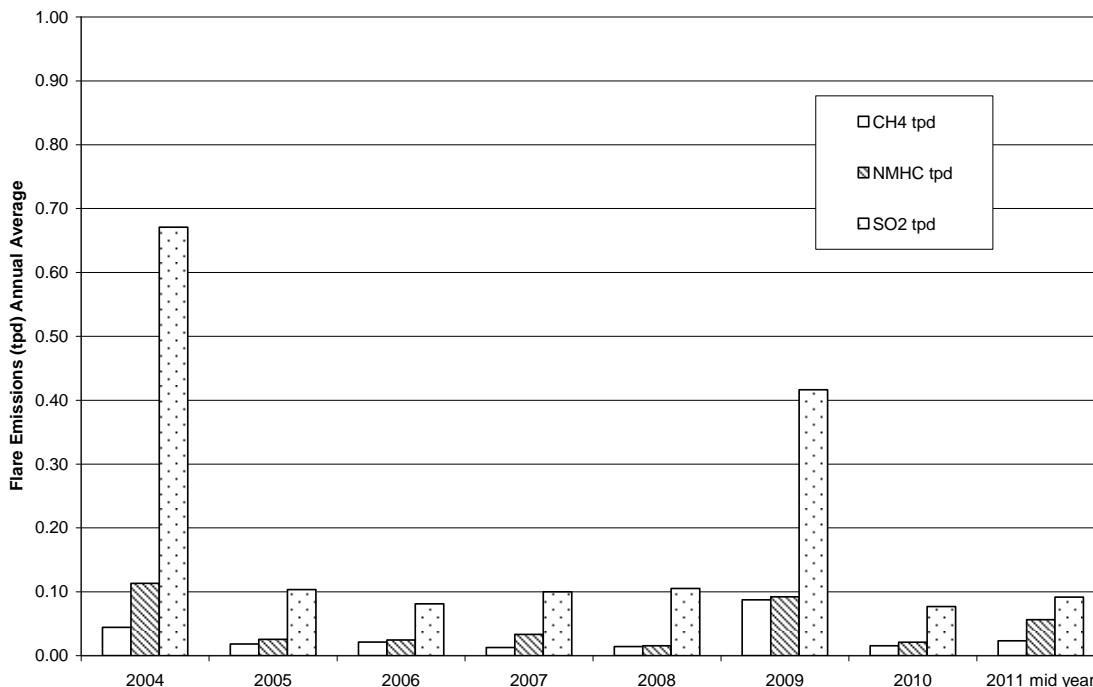

The Rodeo Refinery installed and has utilized a Flare Gas Recovery Compressor since the mid-70's. Historic practices emphasized flare minimization. Some of the recent flaring reductions have occurred due to improved monitoring and tracking of flare volumes as well as attributing causes to all flaring as required by BAAQMD 12-11 and 12-12 and internal policies for incident investigation. Other efforts to minimize flare emissions have occurred through communication and improved awareness. Flare Key Performance Indicators (KPIs) are shared throughout the organization.

High flare volumes in 2004 and 2009 were due to significant turnaround activities taking place. Key pressure vessels in the flare gas recovery system were removed from service for required 10 year vessel metallurgical inspections in 2009. Maintenance was also conducted on the Flares.

In the second half of 2010 the facility experienced a number of flaring events due to the unplanned shutdowns of the 3rd party Hydrogen supplier. COP worked closely with the 3rd party Hydrogen supplier to improve reliability at their facility. Work began in 2010 and continued up until mid-2011 when the supplier made significant equipment reliability upgrades during a planned shutdown. COP also undertook a number of measures to reduce the impact an unplanned shutdown occurs in respect to sudden changes in fuel gas pressure and volume. See Measures Taken to Reduce Flaring and Attachment H for more details on the specific changes made.

In August 2009 three new, redundant liquid ring Flare Gas Recovery Compressors were installed and put in service. The purpose of the new compressors is to provide additional capacity on a consistent basis and to provide for backup compressor capacity. The new compressors are of a different design than the existing compressor and are designed to handle a wider range of composition and of flare gas. They are also less susceptible to liquid carryover impacts.

Based on a review of small flaring events, the addition of the new Flare Gas Recovery Compressors has reduced the number and volume of brief peak exceedances that previously occurred. This trend was observed in 2009 as well as 2010. More importantly, the new compressors were operated in 2009, 2010, and in 2011 while the older compressor was shutdown for maintenance activities. In the past this type of maintenance activity would have resulted in consecutive days of flaring. In these cases the new compressors picked up the flare gas recovery load for a number of days and were effective in reducing flaring volumes.

Another improvement which has occurred is due to improved planning prior to the occurrence of flare activity. Flaring typically occurs during turnarounds when either the gas quality or quantity is not recoverable by the Fuel Gas Recovery Compressor or System. Turnaround planning is conducted to review the periods when flaring may occur. Prior to the turnaround activity, a team discusses these periods in order to determine methods to minimize flaring. Operating procedures and timing of turnaround activities are revised to incorporate flare minimization techniques. In 2010, an operational change was implemented at one of the units which eliminated approximately 6 hours of flaring that would have occurred in the past. In early 2011 the manner in which Unit 110 Hydrogen Plant shutdown and startups was changed. This resulted in a significant reduction in the period of flaring which occurs during each of these activities. Additionally, although not apparent from the flare trends, there are a number of unit shutdowns that occur each year in which little or no flaring occurs. This is due to past implemented and current practices to reduce or eliminate flaring.

1.3 Certification

I certify that, based on the information available to me, the flare minimization plan is accurate, true, and complete.

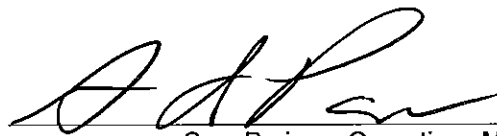

Sam Parino – Operations Manager

2.0 Flare System Information

2.1 Background Information for Flare Systems

Refineries process crude oil by separating it into a range of components, or fractions, and then rearranging those components to better match the yield of each fraction with market demand. Petroleum fractions include heavy oils and residual materials used to make asphalt or petroleum coke, mid range materials such as diesel (heating oil), jet fuel and gasoline, and lighter products such as butane, propane, and fuel gases.

The San Francisco Refinery is organized into groups of process units, with the general goal of maximizing the production of transportation fuels. Each unit takes in a set of feed streams and produces a set of product streams with the composition changed (or upgraded) as one step toward production of an optimal mix of refined products. Many of these processes operate at elevated temperatures and pressures, and a critical element of safe design is having the capability of releasing excess pressure via relieving devices to the flare header to manage excess materials in a controlled manner. These separation and rearrangement processes also produce and/or consume materials that are gases at atmospheric pressure. As a final step in processing, many units provide treatment to conform to environmental specifications such as reduced sulfur levels.

The refinery is designed and operated so that there will be a balance between the rates of gas production and consumption. Under normal operating conditions, essentially all gases that are produced are routed to the refinery fuel gas system, allowing them to be used for combustion in refinery heaters and boilers. Typical refinery fuel gas systems are configured so that the fuel gas header pressure is maintained by making up natural gas to meet the net fuel requirement. This provides a simple way to keep the system in balance so long as gas needs exceed the volume of gaseous products produced. Additional operational flexibility is typically maintained by having the ability to add butane and having the capability to adjust the rate of fuel gas consumption to a limited extent at the various refinery users (e.g. heaters, boilers, cogeneration units).

A header for collection of vapor streams is included as an essential element of nearly every refinery process unit. These are referred to as "flare headers", as the ultimate destination for any net excess of gas is a refinery flare. One of the primary functions of the flare header is safety. It provides the process unit with a controlled outlet for any excess vapor flow, making it an essential safety feature of every refinery. The flare header also has connections for equipment depressurization and purging related to maintenance turnaround, startup, and shutdown, as well as pressure relief devices to handle upsets, malfunctions, and emergency releases.

Knockout drums are in place for separation of entrained liquid. This minimizes the possibility of liquid being carried forward to the flare or flare gas compressor. The vapor stream from the unit knockout drum is then routed to the refinery flare gas recovery system.

The refinery flare system consists of a series of branch lines from various unit collection systems which join a main flare header. The main flare header is in turn connected to both a flare gas recovery system and to the flares. Normally all vapor flow to the flare header is recovered by the flare gas recovery compressor, which increases the pressure of the flare gas allowing it to be routed to a gas treater for removal of contaminants such as sulfur and then to the refinery fuel gas system. Gases that cannot be recovered or used by the flare gas recovery compressor, the treater(s), and/or the fuel gas system end users flows to a refinery flare so it can be safely disposed of by combustion.

A flare seal drum is located at the base of each flare to serve several functions. A level of water is maintained in the seal drum to create a barrier which the gas must cross in order to get to the flare stack. The depth of liquid maintained in the seal determines the pressure that the gas must reach in the flare header before it can enter the flare. This creates a positive barrier between the header and the flare, ensuring that so long as the flare gas recovery system can keep pace with net gas production, no gas from the flare header will flow to the flare. It also guarantees a positive pressure at all points along the flare header, eliminating the possibility of air leakage into the system. Finally it provides a positive seal to isolate the flare, which is an ignition source, from the flare gas header and the process units. The flare systems combine two flares with different water seal depths, effectively "staging" operation of the flares.

Gases exit the flare via a flare tip which is designed to promote proper combustion over a range of gas flowrates. Steam is used to improve mixing between air and hydrocarbon vapors at the flare tip, so as to improve the efficiency of combustion and reduce smoking. A continuous flow of gas to each flare is required for two reasons. Natural gas pilot flames are kept burning at all times at the flare tip to ignite any gas flowing to the flare. Additionally, a small purge gas flow is required to prevent air from flowing back into the flare stack.

The sources of normal or base level flow to the refinery flare gas collection system are varied, but in general result from many small sources such as leaking relief valves, instrument purges, and pressure control for refinery equipment items (e.g. overhead systems for distillation columns). Added to this base load are small spikes in flow from routine maintenance operations, such as clearing hydrocarbon from a pump or filter by displacing volatiles to the flare header with nitrogen or steam. Additional flare load results from routine process functions, such as drum depressurization at the delayed coking unit.

Flaring often occurs during unit startups and shutdowns or when pieces of equipment associated with units are taken out of service. Equipment maintenance results in the need for removal of hydrocarbon from process equipment and associated piping before opening, for both safety and environmental reasons including compliance with BAAQMD Regulation 8 Rule 10. Typical decommissioning procedures include multiple steps of depressurization, and purging with nitrogen or steam to the flare header. During these steps, the quality of the fuel gas is degraded and at times cannot be recovered. During startups, low quality gases may also be produced which are not desirable to be recovered. Additionally, when multiple units are shutdown, flaring can occur when gases are being produced at one unit and an interrelated unit which normally utilizes the gases, such as hydrogen, have not yet been started up.

Although maintenance-related flows can be large, the design and sizing of refinery flare systems is without exception driven by the need for safe disposal of much larger quantities of gases during upsets and emergencies. A major emergency event, such as a total power failure, will require the safe disposal of a very large quantity of gas and hydrocarbon materials during a very short period of time in order to prevent a catastrophic increase in system pressure. The flow that the flare system could be called upon to handle during an event of this type is several orders of magnitude greater than the normal or baseline flowrate.

2.2 Technical Data – Description of Flaring Systems (401.1)

This section contains the information required under 401.1 in regards to required Technical Data.

2.2.1 ConocoPhillips, San Francisco Refinery Flare & Fuel Gas Recovery System Overview

2.2.1.1 General Flare Gas System Overview

The ConocoPhillips Rodeo Refinery has a flare gas recovery system in which liquids and gases are recovered the majority of the time, cleaned, and utilized as fuel gas in facility heaters and the co-generation plant. When gases cannot be recovered due to quality or quantity issues gases would be routed to the flare. There are two flares on site which function in a semi-cascading manner. The C-1 Main Flare (S-296) is the primary flare that is utilized. The MP-30 Flare (S-398) is used during significant events (i.e. major utilities failure) and during times in which the Main Flare is shut down for maintenance. The Refinery flare system consists of the following key components:

- Flare gas compressor recovery system;
- Liquid recovery system;
- Video monitoring system;
- Flare gas flow measurement system;
- Automated flare gas sampling system, and
- Smokeless flare installation.

See Attachment A for simplified diagram of the flare gas recovery system. Attachment B contains a detailed description of the refinery flare gas system. Attachments K and L contain information on the flares and compressors, respectively.

2.2.2 Detailed process flow diagram, PFD (401.1.1)

See Attachment C for PFD of SFR Flare System components. The PFD contains the information required under 401.1.1. The PFD contains the pipelines, process unit blowdown origins, flare gas recovery system equipment, water seals, surge drums, knock-out pots, and other equipment associated with the flare system. The drawing contains the dimensions and capacities of the flare gas recovery system, compressor, water seals, surge drums, and knockout pots.

2.2.3 Description of Monitoring and Control Equipment (401.1.2)

Locations of flowmeters, temperature and pressure indicators are shown on the PFDs referenced in the section above. Locations of sample points and monitoring equipment are also shown on the PFDs. Listed below are the monitors and controls associated with the flare gas recovery system as required by 401.1.2.

2.2.3.1 C-1 Main Flare (S-296)

Flare System Flowmeters

<i>Main Flare (S-296) – Flare System Flowmeters</i>				
<i>Tag Number</i>	<i>Description</i>	<i>Location</i>	<i>Type (e.g. sonic)</i>	<i>Range (X – Y scfd)</i>
Flare Gas Flow:				
RFLRE:19FI0520	Main Flare 42" Line	42" Line - Upstream of Flare Stack Water Seal (C-1)	Ultrasonic Flowmeter	0 - 60,000
RFLRE:19FI0520l.	42" Line - low range			0 - 2,000
RFLRE:19FI0520h.	42" Line - high range			0 - 60,000
RFLRE:19FI0513A.	Main Flare 42" Line	42" Line - Upstream of Flare Stack Water Seal (C-1)	Anemometer ¹	0 - 110,000
RFLRE:19FI0586	Main Flare 10" Line	10" Line - From U200 & U267	Ultrasonic Flowmeter	0 - 20,000
RFLRE:19FI0586l.	10" Line - low range			0 - 2,000

Main Flare (S-296) – Flare System Flowmeters				
Tag Number	Description	Location	Type (e.g. sonic)	Range (X – Y scfd)
RFLRE:19FI0586h.	10" Line - high range			0 - 20,000
RFLRE:19FI0513.	Main Flare 10" Line	10" Line - From U200 & U267	Anemometer ¹	0 - 6000
<u>Purge Gas Flow:</u>				
RFLRE:19FIC0510.	Natural Gas Purge	Purge into Flare Stack (C-1)	Orifice Plate	0 - 930 MSCFD
RFLRE:19FI0521.	Natural Gas Purge	Purge into Flare Stack (C-1)	Orifice Plate	0 - 25 MSCFD

¹ Does not meet 12-11 accuracy requirements for all ranges. Utilized as a backup meter, when necessary.

Continuous Recording Instruments

Main Flare (S-296) – Continuous Recording Instruments			
Tag Number	Description	Location	Instrument Type
RFLRE:19PIC0530.	200:19F-1 PRESSURE	Refinery Relief Blowdown Drum (F-1) Pressure	Pressure Indicator
RFLRE:19PI0520.	42" Line - Upstream of Flare Stack Water Seal (C-1) (integrated with ultrasonic flowmeter)	42" Line - Upstream of Flare Stack Water Seal (C-1)	Pressure Indicator

Main Flare (S-296) – Continuous Recording Instruments			
Tag Number	Description	Location	Instrument Type
RFLRE:19PI0586.	Main Flare 10" Line (integrated with ultrasonic flowmeter)	10" Line - From U200 & U267	Pressure Indicator
Level			
RFLRE:19LIC0512.	200:19F-3 Water Seal Level	19F-3 Water Seal	Water Seal Level Indicator
RFLRE:19LI0508.	200:19C-1 Flare Stack Water Seal Level	19C-1 Flare Stack	Water Seal Level Indicator
Temperature			
RFLRE:19TI0520.	200:Flare Blowdown Line Temperature	42" Line - Upstream of Flare Stack Water Seal (C-1)	Temperature
RFLRE:19TI0586.	200:10" Line Flare Blowdown Line Temperature	10" Line - From U200 & U267	Temperature
RFLRE:19TI0528A.	200:19C-1 Flame Sensor	Flare Tip	Thermocouple
RFLRE:19TI0528B.	200:19C-1 Flame Sensor	Flare Tip	Thermocouple

Main Flare (S-296) – Continuous Recording Instruments			
Tag Number	Description	Location	Instrument Type
RFLRE:19TI0528C.	200:19C-1 Flame Sensor	Flare Tip	Thermocouple
RFLRE:19TI0528D.	200:19C-1 Flame Sensor	Flare Tip	Thermocouple
Analyzers			
RFLRE:19AI0520.	42" Line - Molecular Weight	42" Line - Upstream of Flare Stack Water Seal (C-1)	MW Indicator
RFLRE:19AI0586.	10" Line – Molecular Weight	10" Line - From U200 & U267	MW Indicator
RFLRE:19AI0501.	42" Line - Oxygen	42" Line - Upstream of Flare Stack Water Seal (C-1)	Oxygen Content Indicator

2.2.3.2 MP-30 Flare (S-398)

Flare System Flowmeters

MP-30 Flare (S-398) – Flare System Flowmeters				
Tag Number	Description	Location	Type (e.g. sonic)	Range (X – Y scfd)
Flare Gas Flow:				
RFLRE:19FI0584.	MP30 48" Line	48" Line - Downstream of Water Seal (F-604)	Ultrasonic Flowmeter	
RFLRE:19FI0584L.	48" Line - low range			0 - 2,000
RFLRE:19FI0584H.	48" Line - high range			0 - 35,070
RFLRE:19FI0585.	36" Line	36" Line - from Refinery Blowdown Line (F-2)	Ultrasonic Flowmeter	0 - 120,000
RFLRE:19FI0585L.	36" Line – low range			
RFLRE:19FI0585H.	36" Line – high range			
<u>Purge Gas Flow</u>				
RFLRE:19FIC0511.	Natural Gas Purge		Orifice Plate	0 - 930 MSCFD

¹ Does not meet 12-11 accuracy requirements for all ranges. Utilized as a backup meter, when necessary.

Continuous Recording Instruments

MP-30 Flare (S-398) – Continuous Recording Instruments			
Tag Number	Description	Location	Instrument Type
Pressure			
R230:PI6014.	230F-600 Blowdown Drum	Upstream of MP30 Relief Blowdown Drum (F-600)	Pressure Indicator
RFLRE:19PI0584.	MP30 48" Line	48" Line - Downstream of Water Seal (F-604)	Pressure Indicator
Level			
R230:LIC654A.	230:F-604 MP30 Flare System Water Seal Make Up H2O Level	F-604 Vessel	
R230:LIC654B.	230F-604 MP30 Flare System Water Seal H2O Drain Level	F-604 Vessel	
RFLRE:19LI0509.	200:(C-602) Flare Stack Water Seal	MP30 Flare Stack (C-602) Water Seal	Water Seal Level Indicator
Temperature:			
RFLRE:19TI0584.	200:MP30 Flare Vapor Temperature	48" Line - Downstream of Water Seal (F-604)	Temperature

MP-30 Flare (S-398) – Continuous Recording Instruments			
Tag Number	Description	Location	Instrument Type
RFLRE:19TI0529A.	200:(C-602) NW Flare Pilot	Flare Tip	Thermocouple
RFLRE:19TI0529B.	200:(C-602) NE Flare Pilot	Flare Tip	Thermocouple
RFLRE:19TI0529C.	200:(C-602) SE Flare Pilot	Flare Tip	Thermocouple
RFLRE:19TI0529D.	200:(C-602) SW Flare Pilot	Flare Tip	Thermocouple
Analyzers			
RFLRE:19AI0584.	200:MP30 Flare Vapor Molecular Weight	48" Line - Downstream of Water Seal (F-604)	Molecular Weight Indicator
RFLRE:19AI0502.	200:MP30 Flare Oxygen	48" Line - Downstream of Water Seal (F-604)	Oxygen Content Indicator

2.2.3.3 Unit 200 Flare Gas Recovery Compressor (G-503)

See Attachment C and L for diagrams showing locations of meters and analyzers.

Flowmeters

Flare Gas Recovery Compressor (G-503) Flowmeters				
Tag Number	Description	Location	Type (e.g. sonic)	Range (X – Y MMSCFD)
Gas Flow:				
R200:FI_506B.	Flare Gas Recovery Compressor (G-503)	Downstream of Salt Water Exchanger E-510	Orifice Plate	0 – 4.64

Monitors and Instruments

Note: All setpoints and alarms are subject to change. These values may change as operational or safety optimization opportunities are identified. This list contains the values at the time of publication.

Flare Gas Recovery Compressor (G-503) Monitors and Instruments

Flare Gas Recovery Compressor (G-503) Monitors & Instruments				
Tag Number	Description	Location	Att	Setpoint or Alarms
Pressure				

Flare Gas Recovery Compressor (G-503) Monitors & Instruments				
Tag Number	Description	Location	Att	Setpoint or Alarms
R200:PI0509.	200:F-509 Separator Overhead	F-509 Separator Overhead	C	0.5 psig Alarm 0.0 psig – Action automatic unloading of compressor cylinders
R200:PI0513.	200:G-503 1st Stage	Downstream of 1 st Stage	C	None
R200:PI0515.	200:G-503 2nd Stage	Downstream of 2 nd Stage	C	None
R200:PI0514.	200:G-503 Frame Oil	Downstream of Frame Oil Filters	L	None
R200 – PAL 575	200: G-503 Frame Oil (Local Indication)	Downstream of Frame Oil Filters	L	Shutdown Compressor - < 16 psig
Temperature				
R200:TI0509.	200:F-509 Separator Overhead	F-509 Separator Overhead	C	Alarm – 150 °F
R200:TI0511.	200:G-503 Flare Gas Recovery Compressor 1st Stage	Downstream of 1 st Stage	C	None
R200:TI0513.	200:G-503 Flare Gas Recovery Compressor 2nd Stage	Downstream of 2 nd Stage	C	Alarm – 300 °F Shutdown - 350 °F
R200:TI0510.	200:G-503 Tempered Water	Upstream of Exchanger E-512	L	None
R200:TI0512.	200:G-503 Frame Oil	Downstream of Frame Oil Pump	L	None

Flare Gas Recovery Compressor (G-503) Monitors & Instruments				
Tag Number	Description	Location	Att	Setpoint or Alarms
Analyzer				
R200:AI0504.	200:G-503 Discharge Specific Gravity (SG)	Compressor Discharge	L	Alarm Low SG – 0.60 Alarm High SG – 1.12
R200 - AE503.	200:G-503 Compressor Discharge Oxygen Analyzer	Compressor Discharge	L	Alarm – 1.5% O ₂
Level Indicator				
R200:L 509	200:F-509 Level Indicator (Local Indicator)	F-509 Low Pressure Separator	L	Level is monitored by Operator.
R200 – LAH 510	200:F-509 Level Shutdown (Local Indicator)	F-509 Low Pressure Separator	L	Shutdown Compressor – 30% Level
R200 – LAH 537	200:F-503A Level Shutdown (Local Indicator)	F-503A G-503 First Stage Suction Pulsation Dampener	L	Shutdown Compressor – 75% Level
R200 – LAH 538	200:F-503C Level Shutdown (Local Indicator)	F-503C: G-503 Second Station Suction Pulsation Dampener	L	Shutdown Compressor – 75% Level
R200 – LAH 541	200:F-503E Level Shutdown (Local Indicator)	F-503E: G-503 Second Stage Suction Knock Out Pot	L	Shutdown Compressor – 90% Level

2.2.3.4 Unit 200 Liquid Ring Flare Gas Recovery Compressors (G-540A/B/C)

Note: All data in this section is preliminary and subject to change. These values and meter numbers may change as operational or safety optimization opportunities are identified. The Compressor is undergoing a Process Hazard Analysis (PHA) at the time of the FMP update, which may result in additional changes. At this time all ranges and setpoints are being developed and thus are shown as pending.

See Attachment C and L for diagrams showing locations of meters and analyzers.

Flowmeters

Liquid Ring Flare Gas Recovery Compressor (G-540 A/B/C) Flowmeters				
Tag Number	Description	Location	Type (e.g. sonic)	Range (X – Y MMSCFD)
Gas Flow:				
FI-1573	Liquid Ring Flare Gas Recovery Compressor (G-540A, B, & C) Flow	Downstream of F-540 Gas Separator Drum	Orifice	0 – 6,000 MSCFD
Service Liquid Flow:				
FI-1544 (A) FI-1545 (B) FI-1546 (C)	Compressor Service Liquid Flow Indication, Alarm, & Shutdown	To Compressor	Orifice	0-200 gpm <u>Alarms:</u> Low Low 100 (SD) Low 110 gpm High 150 gpm

Monitors and Instruments

Note: All data in this section is preliminary and subject to change. These values may change as operational or safety optimization opportunities are identified. The Compressor is undergoing a Process Hazard Analysis (PHA) at the time of the FMP update, which may result in additional changes.

Liquid Ring Flare Gas Recovery Compressor (G-540 A/B/C) Monitors and Instruments

Liquid Ring Flare Gas Recovery Compressor (G-540 A/B/C) Monitors & Instruments				
Tag Number	Description	Location	Att	Setpoint or Alarms
Pressure				
PI-1541	High Pressure Alarm and Shutdown	Flare Gas to Compressor	C	Alarm High 115.3 psig Alarm High High 125.3 psig (SD)
PI-1543	Low & High Suction Pressure Alarm	Flare Gas to Compressor	C	Alarm High 18.5 psia Alarm Low 14.7 psia
PI-1881 (A) PI-1882 (B) PI-1883 (C)	Compressor Dual Seal Low Pressure Alarm	Compressor Seal	C	Alarm Low 50 psig
Temperature				

Liquid Ring Flare Gas Recovery Compressor (G-540 A/B/C) Monitors & Instruments				
Tag Number	Description	Location	Att	Setpoint or Alarms
TI-1540	Suction Temperature Alarm and Shutdown	Compressor Suction	C	Alarm High 150 °F Alarm High High 170 °F (SD)
TI – 1547 (A) TI-1548 (B) TI-1549 (C)	Compressor Temperature Discharge Gas Temperature Indication, Alarm, & Shutdown	Discharge of Compressor	C	Alarm High 150 °F Alarm High High 170 °F (SD)
TAH-1545	Service Water Temperature Alarm	Service Water to Compressor	C	Alarm High 150 °F
Analyzer				
VI-1541 (A) VI-1542 (B) VI-1543 (C)	Compressor Vibration Alarms	Connected to compressor	C	High Alarm 0.4 in/second High High Alarm 0.6 in/second (SD)
Level Indicator				
LI-1881 (A) LI-1882 (B)	Compressor Dual Seal Low Level Alarm	Compressor Seal	C	Alarm Low 35%

Liquid Ring Flare Gas Recovery Compressor (G-540 A/B/C) Monitors & Instruments				
Tag Number	Description	Location	Att	Setpoint or Alarms
LI-1883 (C)				
LAHH-1543	Compressor Suction Liquid Level Alarm and Shutdown	Compressor Suction	C	Alarm Low 32%
LAHH-1540	Gas Separator Drum Liquid Level Alarm & Shutdown	F-540 Gas Separator Drum	C	Alarm High 85% Alarm High High 99% (SD) Alarm Low 15.2% Alarm Low Low 4.3% (SD)
LAH-1542	Gas Separator High Level Alarm	F-540 Gas Separator Drum Blowdown Side	C	Alarm Low 10%

3.0 Reductions & Planned Reductions

3.1 Reductions Previously Realized (401.2)

Changes or Equipment in Place prior to 2003 which Prevent or Minimize Flaring

Due to economics and community concern, the refinery has a long history of flare minimization practices. The Flare Gas Recovery Compressor (G-503) was installed in the early 70's. Up until 2000 the facility utilized a ground flare that was located near I-80. When the flare was utilized the flame was very visible from the highway. Prior to 2000 the Refinery Management had expectations for Operations to increase facility reliability to prevent upsets and to develop a means to conduct Startups & Shutdowns with minimal flaring. Those practices remain in place today.

Another item of note is the existing Sulfur Recovery Unit system. The facility has four Sulfur Recovery Units (U234, 235, 236, & 238) which can provide for significant redundancy. This has allowed the facility to experience only one instance of acid gas flaring in the past five years from a complete refinery shutdown. The Sulfur Plants have been in place for over 30 years.

In 1999, the Unit 200 Wet Gas Compressor (G-501) seal was upgraded to a dry seal system. Previously, the seal would fail every 12 – 24 months which required a seal replacement. The seal replacement would take approximately 5 – 6 days and flaring would occur throughout this period. After the dry seals were installed, the on-line performance of the Compressor significantly improved. The compressor has not experienced a seal failure since the seal upgrade. The upgrade has resulted in a reduction of approximately 4 - 6 MMSCFD of gas flared for approximately 5 days every 12 – 24 months.

Starting in 2003 weekly updates and quarterly Key Performance Indicators (KPIs) are reported & distributed with Flaring History to all Refinery employees. The content and distribution of the KPIs is described in Environmental Services Department (ESD) Policy and Procedure 1.1 "Environmental KPIs". The KPIs issued show trends and causes for flaring events and other reportable environmental events. The KPIs helps reduce flaring by showing all employees this is important in that it is tracked and communicated.

Changes Made to Reduce Flare Emissions

May 30, 2003 to June 30, 2010

In accordance with 401.2, listed below are reductions that have been made to reduce flaring over the past 5 years. Many of the items listed are Management System improvements. Although some of these improvements are difficult to quantify, they have had a significant impact on minimizing flaring.

Changes Made to Reduce Flare Emissions (May 30, 2003 – June 30, 2010)	
Year Installed or Implemented	Equipment Item Added, Process Changed or Procedure Implemented
Procedures:	
3 rd Qtr 2005 3 rd Qtr 2007 (updated) 3 rd Qtr 2009 (updated) 3 rd Qtr 2011 (updated)	<p>Refinery Policy & Procedure (P&P) 6-7 “Flare Monitoring & Reporting” -</p> <ul style="list-style-type: none"> • Procedure created to communicate flare sampling, monitoring, & root cause analysis requirements. The contents of the procedure include Responsibilities for personnel at the refinery in respect to flare compliance activities. • Sets standards for accountability in regards to monitoring, reporting, and preventing recurrence. • Criteria for agency release reporting (i.e. CA OES, CCC HSD, BAAQMD, NRC, etc.) for flare events. • Summary of BAAQMD 12-11 flare monitoring requirements (e.g. video, flare flow, sampling), • Summary of various regulatory reporting requirements. • Criteria for incident investigation in respect to BAAQMD regulations and the ConocoPhillips EPA Consent Decree. • Means to track flare events with COP Corporate incident tracking system. <p>This procedure reduces flaring by demonstrating to employees that those who have defined roles must follow the steps outlined in the procedure and that these activities are important. It also mandates expectation for consistent evaluation of flaring events & development of corrective actions to prevent recurrence.</p>

Changes Made to Reduce Flare Emissions (May 30, 2003 – June 30, 2010)	
Year Installed or Implemented	Equipment Item Added, Process Changed or Procedure Implemented
<p>2nd Qtr 2005 3rd Qtr 2009 (updated)</p>	<p>Refinery Policy & Procedure (P&P) 5-1 “Incident Investigation” & Incident Investigation Training - P&P 5-1 establishes responsibilities, event triggers, and typical means for conducting incident investigations. The contents of the procedure include:</p> <ul style="list-style-type: none"> • Definition of the types of incidents that can occur (i.e. minor, serious, major). • Responsibilities for employees that discover an incident and who must complete tasks in respect to incident investigations. • Establishes accountability. • Description of whom and when personnel should be notified of incidents. • Defines who should participate in an incident investigation. • Description of the investigation process. • How the findings of an incident investigation are reviewed. • How findings of an incident investigation should be communicated to employees and ConocoPhillips sister refineries. • How corrective actions should be addressed. <p>The existing procedure was updated to denote environmental related events requiring incident investigation. Flaring events are identified in the procedure. P&P 6-7 cross references P&P 5-1. This procedure reduces flaring by demonstrating to employees that those who have defined roles must follow the steps outlined in the procedure and that these activities are important. Without this procedure incidents which occur would not necessarily be investigated and addressed in a consistent fashion. The main value in flaring reduction is that this procedure requires that corrective actions be developed and addressed for incidents.</p>
<p>4th Qtr 2009 & on-going (training)</p>	<p>To ensure good quality investigations are conducted the facility identified key personnel to receive incident investigation training. Training ensured that first reporting (basic who, what, when, where) captures critical initial information. The training also ensures that investigations receive the necessary level of investigation and get to defined root causes. Additional work is on-going to improve and maintain the quality of the investigations conducted.</p>

Changes Made to Reduce Flare Emissions (May 30, 2003 – June 30, 2010)	
Year Installed or Implemented	Equipment Item Added, Process Changed or Procedure Implemented
Procedures:	
2 nd Qtr 2003 (approx.) 2 nd Qtr 2010 (updated)	<p>Emergency Operating Procedure EOP-1 “Guidelines for Standard Public Address System Announcements” - Enhanced Communication within the Facility when Flare Gas Recovery System Load Increases – For example, the facility Public Announcement system is currently used if an increase in the compressor load occurs. This requires process units to review their operations in order to find the cause of the increase and take actions to mitigate. This prevents some flaring events from occurring in that discretionary gases, such as nitrogen purges and hydrogen, sent to the flare gas recovery system can be scheduled around peak loading periods to maximize gases recovered. Coordination of these activities is done through Operators at various units and Shift Supervisors working together to coordinate their activities in respect to use of the flare gas blowdown system. This minimizes flaring by consciously identify periods in which the blowdown system can be utilized without overloading the flare gas recovery compressor. This results in less periods of flaring due to brief peak loading of the compressor. In addition to this process, the Public Announcement system is utilized during planned and emergency events as specified in some of the Unit 200 procedures (ESOP & NSOP-<i>various</i>-200) to improve equipment use and switching. For example, if the Flare Gas Recovery Compressor (G-503) is put into Wet Gas or Odor Abatement service the public announcement system will be utilized to notify plant personnel of the change in operation. Listed below is a partial list of some of the key procedures where the public announcement system use is referenced:</p>

Changes Made to Reduce Flare Emissions (May 30, 2003 – June 30, 2010)					
Year Installed or Implemented	Equipment Item Added, Process Changed or Procedure Implemented				
	<table style="width: 100%; border: none;"> <thead> <tr> <th style="text-align: center; width: 50%;"><u>Normal Operating Procedures</u></th> <th style="text-align: center; width: 50%;"><u>Emergency Operating Procedures</u></th> </tr> </thead> <tbody> <tr> <td style="vertical-align: top;"> <ul style="list-style-type: none"> • NSOP-001-200 Relief “U200 Table of Safe Operating Limits” • NSOP-306-200 “Light Ends Shutdown, Unit Running” • NSOP-704-200 “G-501 Compressor Shutdown & Clean-up” • NSOP-707-200 “G-503 Flare Compressor Planned Shutdown” • NSOP-709-200 G-503 Flare Compressor Start-up • NSOP-710-200 “Switching G-503 to Wet Gas Service” • NSOP-711-200 “Switching G-503 from Wet Gas to Flare Service” • NSOP-716-200 “Switching G-503 to Odor Abatement Service” • NSOP 717-200 “G-503 Flare Compressor Circulation” </td> <td style="vertical-align: top;"> <ul style="list-style-type: none"> • ESOP-700-200 “Loss of G-501 Compressor” • ESOP-701-200 “G-503 Compressor Failure” </td> </tr> </tbody> </table>	<u>Normal Operating Procedures</u>	<u>Emergency Operating Procedures</u>	<ul style="list-style-type: none"> • NSOP-001-200 Relief “U200 Table of Safe Operating Limits” • NSOP-306-200 “Light Ends Shutdown, Unit Running” • NSOP-704-200 “G-501 Compressor Shutdown & Clean-up” • NSOP-707-200 “G-503 Flare Compressor Planned Shutdown” • NSOP-709-200 G-503 Flare Compressor Start-up • NSOP-710-200 “Switching G-503 to Wet Gas Service” • NSOP-711-200 “Switching G-503 from Wet Gas to Flare Service” • NSOP-716-200 “Switching G-503 to Odor Abatement Service” • NSOP 717-200 “G-503 Flare Compressor Circulation” 	<ul style="list-style-type: none"> • ESOP-700-200 “Loss of G-501 Compressor” • ESOP-701-200 “G-503 Compressor Failure”
<u>Normal Operating Procedures</u>	<u>Emergency Operating Procedures</u>				
<ul style="list-style-type: none"> • NSOP-001-200 Relief “U200 Table of Safe Operating Limits” • NSOP-306-200 “Light Ends Shutdown, Unit Running” • NSOP-704-200 “G-501 Compressor Shutdown & Clean-up” • NSOP-707-200 “G-503 Flare Compressor Planned Shutdown” • NSOP-709-200 G-503 Flare Compressor Start-up • NSOP-710-200 “Switching G-503 to Wet Gas Service” • NSOP-711-200 “Switching G-503 from Wet Gas to Flare Service” • NSOP-716-200 “Switching G-503 to Odor Abatement Service” • NSOP 717-200 “G-503 Flare Compressor Circulation” 	<ul style="list-style-type: none"> • ESOP-700-200 “Loss of G-501 Compressor” • ESOP-701-200 “G-503 Compressor Failure” 				

Changes Made to Reduce Flare Emissions (May 30, 2003 – June 30, 2010)	
Year Installed or Implemented	Equipment Item Added, Process Changed or Procedure Implemented
1 st Qtr 2006	<p>Normal Safe Operating Procedure (NSOP) NSOP-900-200 “Drum Switching” Operational Improvement</p> <p>Flaring can occur during Unit 200 Coker drum cooling due to brief peak loading to the flare gas recovery compressor. Changes have been made which reduced the instances of this flaring. The procedure associated with drum cooling has been revised. The process of Drum Switching involves numerous steps. The procedure was revised to clearly indicate the sequencing of steps involving cooling of the drum and the details surrounding each step. This ensures consistency and repeatability of this activity. In the past the steps were not as clearly defined. This resulted in periods of flaring with some Shifts and no flaring while other Shifts were conducting the same activity. By establishing specific steps this eliminates variability and prevents flaring. Additionally, communication around flare gas compressor loading has been enhanced. This has minimized the amount of instances that flaring occurs during drum cooling.</p>
4 th Qtr 2006	<p>Turnaround Planning Flare Minimization - as part of the FMP, a formal process is utilized for turnarounds. This process had been performed in a consistent manner and lessons learned captured and includes the following:</p> <ul style="list-style-type: none"> • Establishing Personnel Responsibilities for Various Planning Steps • Conducting Review of Potential Flare Minimization Techniques Prior to Turnaround • Documenting Flare Minimization Turnaround Planning Review • Conducting a Post Turnaround Review of Comparison of expected and actual flaring. Discussion of lessons learned and opportunities for improvement • Documenting lessons learned and opportunities for improvement. • Incorporating elements regarding flare minimization and communication of flaring in operating procedures. <p>Identifying corrective actions and taking action to minimize flaring in future turnarounds.</p>

Changes Made to Reduce Flare Emissions (May 30, 2003 – June 30, 2010)	
Year Installed or Implemented	Equipment Item Added, Process Changed or Procedure Implemented
3 rd Qtr 2003(approx.)	Maintenance Startup / Shutdown Coordination – Coordinated the shutdown and startup of units and major pieces of equipment during periods of high flare gas compressor loading in order to minimize total period of flaring. This coordination includes examining the periods when flaring is expected to occur and targets accomplishing shutdown and startup work in similar fashion while minimizing flaring. Some examples include emphasis on communication with Unit 200 operators when going to blowdown to work around drum switching, conducting G-503 Flare Gas Recovery Compressor maintenance when major gas producers are shutdown, staging of nitrogen purging of vessels to minimize the total volume of nitrogen going to blowdown.
Equipment	
3 rd Qtr 2003	Flow Meter Installation on Main & MP30 Flares – Flow meter installation per BAAQMD Regulation 12-11-501. The installation of the flow meters provides for enhanced recognition of flaring events. The flow meters help reduce flaring by providing an accurate means to measure and provide indication as to when flaring is occurring. The flow meters are especially useful for small flaring events which may not be detectable from visual flare stack monitoring only. The meters help to track and record all instances of flaring as well as giving Unit Operators immediate indication that flaring is occurring so that they can take action to reduce flaring.
4 th Qtr 2010	Added an additional ultrasonic meter to a line that was previously only put in service every 5 -10 years. This meter (RFLRE:FI0585) went into service December 2010.

Changes Made to Reduce Flare Emissions (May 30, 2003 – June 30, 2010)	
Year Installed or Implemented	Equipment Item Added, Process Changed or Procedure Implemented
2 nd Qtr 2005	<p>Unit 250 Diesel Hydrotreater Design – This unit was designed with a Zero Power Failure Relief Load. This unit operates under pressure. Typically, hydrotreaters would automatically relieve to a refinery flare blowdown system in the event of a power failure to protect equipment from overpressuring. This unit was designed in a manner that prevents the need for the unit to vent to the flare during a power failure or other loss of utilities. Listed below are the primary means this design was accomplished. .</p> <ul style="list-style-type: none"> • High design pressure of reaction system equipment to contain settle out pressure in event of a power failure. • No automatic reaction system depressuring. • Designed with a manually activated depressuring system. • Product stripper was designed as a steam stripper, eliminating a fired heater and reducing power failure relief load. • Hot Separator was designed with the capacity to contain all oil from the reactors, minimizing impact on the Product Stripper in a power failure.
<ul style="list-style-type: none"> • Phase 1: Dec. 2006 Completed 	<p>Addition of Unit 110 Atmospheric Vent for Hydrogen - Benefit is to vent hydrogen during startup, shutdown, and/or during hydrogen supply imbalances to the atmosphere rather than sending it to the flare. When hydrogen is sent to the flare this results in the shutdown of the flare compressor & flaring of all materials that have been sent to the blowdown system. This project is expected to be phased in. Phase 1 installed a vent which allows a small stream of purified hydrogen (99.99%) to be vented.</p>

Changes Made to Reduce Flare Emissions (May 30, 2003 – June 30, 2010)	
Year Installed or Implemented	Equipment Item Added, Process Changed or Procedure Implemented
<p><u>Milestones (approximate)</u></p> <ul style="list-style-type: none"> • October 2008 – Construction Start • August 2009 Startup (actual) 	<p>Installation of Additional Flare Gas Recovery Compressors G-540A/B/C – The Clean Fuels Expansion Project (CFEP) determined a new Odor Abatement (OA) Compressor would be required to maintain reliability of the OA system during peak loading periods. Initially, the new compressor was to be designed in order to serve in both OA and Flare Gas Recovery Compressor service in order to leverage the use of the new OA compressor. After detailed engineering evaluation and analysis it was determined to install separate compressors in each service. The main benefits will be to allow for additional Flare Gas Recovery Compressor capacity on a consistent basis and to provide for backup compressor capacity. The new Flare Gas Recovery Compressor was also designed to handle the varying composition of flare gas. The Liquid Ring compressor installed is actually a set of 3 compressors that can be used in conjunction with each other or separately. Some of the identified benefits of the Liquid Ring compressor are reliability and it can handle gas quality variations and liquid carryover much more readily than other types of compressors. The total capacity of the three liquid ring compressors is 4.8 MMSCF/D. The new compressors will eliminate the majority of flaring associated with brief peak loading and eliminate flaring that occurs when the G-503 Flare Gas Recovery Compressor is taken out of service for routine maintenance. The compressor and associated fuel gas system will still be limited by gas quality and heating value requirements of the downstream fuel gas combustion sources.</p> <p>The G-503 compressor and one of the Liquid Ring Compressors will be operated at all times with the exception of planned maintenance periods. This will allow for increased capacity in the flare gas recovery compressor system and will be able to pick up swings that occur during brief peak loading on the existing compressor. The 3 new Liquid Ring Flare Gas Compressors will be operated simultaneously when the G-503 compressor is shutdown for planned maintenance. The operational philosophy of this system of compressors will incorporate measures to minimize periods of no flare gas recovery. That will be done by optimizing up time of flare gas recovery by developing operating and maintenance procedures which focus on compressor up time. The system operation may change as operating procedures are developed and actual operation experience is gained.</p> <p>As stated above, a separate Odor Abatement Compressor was installed. The new odor abatement compressor will add an additional compressor to the three currently available.</p>
Processes:	

Changes Made to Reduce Flare Emissions (May 30, 2003 – June 30, 2010)	
Year Installed or Implemented	Equipment Item Added, Process Changed or Procedure Implemented
3 rd Qtr 2003	<p>Monthly Flare Event Reporting - BAAQMD Regulation 12-11-401 requires reporting of all flaring. The requirement to report all events has required enhanced recognition for all flaring events and establishes the history of all flaring events. Reporting of flaring events requires the refinery to recognize all flaring events and track them. These records are used to monitor trends of flaring events as described in the reference to monthly Key Performance Indicator (KPI) tracking: ESD Policy & Procedure 1.1 “Monthly Environmental KPIs” The data is also used for root cause analysis and to identify ways to take action to prevent recurrent flaring.</p>
4 th Qtr 2003	<p>Flare Root Cause Analysis Reporting for Land Use Permit – Under the facility Land Use Permit (LP02-2095) an agreement was made and a condition (S7) was imposed that required the facility to conduct a root cause analysis of any flaring event at the refinery that exceeded 500,000 SCF. The analysis was required to be provided to a Non-Governmental Organization (NGO) and a copy submitted to the BAAQMD. This reporting reduces flaring by requiring the facility to identify causes of flaring which brings focus to potential failures, repetitive activities, and potential trends. This requirement was in place for Rodeo prior to the 12-12 root cause requirement. This condition has now expired. This reporting required the refinery to focus on the cause of events 1-1/2 years prior to the adoption of 12-12. It also caused the facility to start examining causes of flaring events in order to take action to prevent recurrence.</p>
3 rd Qtr 2005 3 rd Qtr 2007 (Land Use Permit addition)	<p>Flare Root Cause Analysis Reporting BAAQMD – Reporting of root cause of flaring events which exceeded a volume of 500,000 SCF/D or 500 lbs SO₂ (4/06) as required by BAAQMD Regulation 12-12-406. Reporting of root cause required the facility to take a closer look at flaring events and ensure that corrective actions had been appropriately identified to prevent recurrence. This reporting reduces flaring by requiring the facility to identify causes of flaring which brings focus to potential failures, repetitive activities, and potential trends. Prevention measures identified to prevent recurrent flaring must also be identified and reported to the BAAQMD. As part of the root cause analysis, actions are defined and taken to prevent recurrence.</p> <p>Under the Clean Fuels Expansion Project (CFEP) Land Use Permit 05-2048 Community Working Group (CWG) agreement the flare Root Cause Analysis reports are required to be provided to the CWG. The RCAs are provided to the CWG when the report is transmitted to BAAQMD.</p>

Changes Made to Reduce Flare Emissions (May 30, 2003 – June 30, 2010)	
Year Installed or Implemented	Equipment Item Added, Process Changed or Procedure Implemented
1 st Qtr 2004	<p>Operational Improvement – Monitoring:</p> <p>Flare System Diagnostic Tools – Developed tools for better flare flow & monitoring capability.</p> <ul style="list-style-type: none"> • PI Process Book Flare System Overviews – tool was developed to provide Supervision & Operations Engineers an overview of the flare system operation. This is useful when load to the flare increases or following a flaring event to better understand triggers for flaring. • Flare Flow Spreadsheet – spreadsheet was developed to be used by Shift Superintendent to monitor flow to the flare in relation to Federal and BAAQMD reporting requirements. The spreadsheet is referenced in Refinery P&P 6-7 “Flare Monitoring & Reporting” <p>The use of this tool helps reduce flaring by letting parties who are responsible for flare reporting and incident investigation management know the magnitude and characteristics of a particular flaring event. It also provides a good snapshot as to when there is a change in the baseline load to the compressor which, if continuing to rise can result in flaring. In some cases, where the cause is not immediately known this can help give insight to the cause which can result in quicker flare minimization.</p>

Changes Made to Reduce Flare Emissions (May 30, 2003 – June 30, 2010)	
Year Installed or Implemented	Equipment Item Added, Process Changed or Procedure Implemented
<p>3rd Qtr 2005</p> <p>3rd Qtr 2009 (update)</p>	<p>Operational Improvement – Drum Cooling</p> <p>Flaring can occur during Unit 200 Coker drum cooling due to brief peak loading to the flare gas recovery compressor. Changes have been made which reduced the instances of this flaring.</p> <p>Communication Enhancements – Increased inter and intra departmental communication during regular periods of high flare gas recovery compressor loading association with Unit 200 Coker drum cooling. This reduces flaring in cases where activities in which discretionary gasses (i.e. small volumes of nitrogen, hydrogen, etc.) are being sent to blowdown can be coordinated. For example, if one unit needs to purge equipment with small amounts of nitrogen which can be absorbed by flare gas recovery this activity could potentially be delayed during Coker drum cooling. Rather than two activities which add increased volume to the flare gas recovery compressor occurring at one time they can be staggered to prevent exceeding the capacity of the flare gas recovery compressor. Since the Coker drum cooling process has a routine schedule, this communication occurs when the unit that needs to send discretionary gasses to blowdown contacts the Operators at Unit 200 in order to coordinate their activities. This communication is important since Operators from various units are currently housed in separate control rooms. As referenced in the Central Control Room item listed under Planned Reductions, this communication will more easily occur when Operators are housed in a central location.</p> <p>Equipment installation – the addition of the new, redundant flare gas recovery compressor G-540 A/B/C increases the capacity of the flare gas recovery system during most operating periods. This has further prevented and minimized the number and volume of small flaring events that occur during drum cools.</p>

Changes Made to Reduce Flare Emissions (May 30, 2003 – June 30, 2010)	
Year Installed or Implemented	Equipment Item Added, Process Changed or Procedure Implemented
1 st 2007	Improved Incident Investigation – Smaller Flare Activity (<500,000 SCFD and/or <500 lbs SO₂)
2 nd Qtr 2009 (update)	Personnel from the Environmental Department and Operations meet on a periodic basis to review all flaring activity to determine potential cause of all flaring events. These regular meetings reinforce that identifying and minimizing all flaring events is important. For example, the PI Process Book Flare System Overview tool that was listed in this section under Operational Improvement - Monitoring has been improved over time in order to more quickly identify the source of smaller flaring events in different flare headers systems. See Attachment H for analysis of smaller flare events. A detailed analysis was initially performed as part of the 2008 FMP update. The results showed small events account for on average 5-10% total annual flow. The new Flare Gas Recovery Compressor G-540 A/B/C has mitigated some of the smaller events.
3 rd Qtr 2010	Unicracker Plant 4 Hydrogen Plant Shutdown Procedure – a new procedure for shutting down the Plant 4 Hydrogen Plant was implemented in order to reduce flaring. The revised procedure was successful and no flaring occurred during a recent shutdown. Based on past experience it was estimated this reduced 4-6 hours of flaring of gasses. This procedure was successfully implemented in 2011 as well.
3 rd Qtr 2010	Installation of Backup Lube Mist System for the G-540 Flare Gas Compressors – a backup lube oil mist system was installed for the new Flare Gas Recovery Compressors. The purpose of this system is to ensure that continuous lubrication is available to each of the compressors. If an oil mist system alarm sounds or failure occurs the backup compressor can be utilized without compressor operation loss.

Changes Made to Reduce Flare Emissions (May 30, 2003 – June 30, 2010)	
Year Installed or Implemented	Equipment Item Added, Process Changed or Procedure Implemented
3 rd Qtr 2010	<p>Operational Improvement – Monitoring:</p> <p>Fuel System Diagnostic Tools – Developed tools for better fuel flow monitoring & optimization capability.</p> <ul style="list-style-type: none"> • PI Process Book Fuel Flow System Overviews – tool was developed to provide Supervision & Operations Engineers an overview of the fuel system operation with key parameters displayed. The key parameters shown include fuel gas produced, natural gas imported, sulfur levels in fuel, fuel consumer demand. • PI Process Book Fuel Imbalance Optimization Tool – an online tool was developed which provide recommended steps for mitigating fuel gas imbalance. The tool lists the steps and limitations for each step which need to be optimized. ” <p>The use of this tool helps to reduce flaring caused due to fuel gas imbalance by providing tools & a multi unit overview of key parameters. Users of the tool can plot trends of key parameters.</p>
1 st Qtr 2011	<p>Unit 110 Hydrogen Plant Startups and Shutdowns – changes have been made in how Unit 110 startups and shutdowns, when conditions warrant, to minimize flaring. For example, a shutdown takes place and human entry is not required, the unit may be purged with plant Nitrogen rather than hot, pumped Nitrogen. This allows for the Nitrogen to slowly be swept into the blowdown system, allowing for the Fuel Gas Recovery Compressor to remain operating. For some shutdowns the amount of flaring has been eliminated vs. a previous average period of of 5-1/2 hours. Unit startups have also been reduced from a period of approximately 2-1/2 hours in comparison to the previous duration of 5 hours.</p>

3.2 Planned Reductions (401.3)

The table below summarizes the actions currently planned to effect further reductions in refinery flaring.

Planned Actions for Reducing Flaring

<i>Planned Actions for Reducing Flaring</i>	
<i>Planned Date of Installation/Implementation</i>	<i>Equipment Item to be Added, Process to be Changed or Procedure to be Implemented</i>
Procedure:	
Equipment	
<ul style="list-style-type: none"> Phase 2: Deferred Permit issuance & operation (expected approx. 10 months following submittal) 	<p>Addition of U110 Atmospheric Vent for Hydrogen - Benefit is to vent hydrogen during startup, shutdown, and/or during hydrogen supply imbalances to the atmosphere rather than sending it to the flare. When hydrogen is sent to the flare this results in the shutdown of the flare compressor & flaring of all materials that have been sent to the blowdown system. This project is expected to be phased in. See Reductions Previously Realized for details about Phase 1. During the Phase I installation the vent installed will physically accommodate a larger volume, up to 12 MMSCF/D of venting. The vent currently contains an orifice which limits the flow to approximately 5 MMSCF/D. Phase 2 would remove the flow limiting orifice to allow for venting of higher volumes of hydrogen during Unit 110 startup. Phase 2 was studied to determine feasibility from an operations, permitting, and environmental benefit standpoint. The results of the Turnaround Planning Flare Minimization process for the most recent Unit 110 planned startup/shutdown was utilized to conduct an evaluation of Phase 2. The strategy for this project needed to be reassessed after bringing on the new unit and use of the third-party hydrogen plant during 3rd Quarter 2009. 2011 update: Due to the changes in the Unit 110 startups and shortened steps in startup this project will not be pursued at this time. We are continuing to evaluate the potential benefit of this vent in light of the reduced duration of flaring.</p>

Planned Actions for Reducing Flaring	
Planned Date of Installation/Implementation	Equipment Item to be Added, Process to be Changed or Procedure to be Implemented
<p>Phased 2006 – 2013</p> <ul style="list-style-type: none"> • 2006 – MP30 (complete) • 2009 – Sulfur Plant (complete) • 2009 – UK (complete) • 2011 – U200/ U267/U250 (complete) • 2014 - U110 & SPP • 2015 – U100 & Bulk <p><i>(completion dates listed)</i></p>	<p>Construction & Operation of Central Control Room (CCR) The CCR has been built and is currently contains the controls for the MP30 Complex. The CCR will eventually house the majority of the process unit Boardman. The Boardman are the Operators that oversee the unit operation and provide direction to Outside Operators. Currently the Boardman are housed in Control Rooms at their individual units. Movement of each unit into the Central Control Room will be phased. The CCR will bring all the Boardman together in one large control room. There is an inherent value in having the Boardman housed in one Control Room that will minimize flaring. Improved communication will occur and better awareness of each unit's impact upon another unit's operation will occur. In addition, optimization by Operations Supervision will be simplified when the unit controls are housed in one Control Room. An example of this benefit is that if one unit is nitrogen purging a vessel which will add loading to the U200 G-503 Flare Gas Recovery Compressor the Boardman can immediately talk to the Unit 200 Boardman about whether or not additional loading can be handled. As the purging is taking place the two Boardman can work closely together to monitor the impact of purging and provide immediate feedback as to the impact of the activity on the Compressor. Adjustments can be made much more quickly to manage the activity. This enhanced coordination will reduce in flaring.</p>

Planned Actions for Reducing Flaring	
Planned Date of Installation/ Implementation	Equipment Item to be Added, Process to be Changed or Procedure to be Implemented
<p><u>Phased 2006 – 2013</u></p> <ul style="list-style-type: none"> • 2006 – MP30 (Complete) • 2009 – Sulfur Plant (complete) • 2009 – UK (complete) • 2011 – U200/ U267/U250 (complete) • 2014 – U110 & SPP • 2015 – U100 & Bulk <p><i>(completion dates listed)</i></p>	<p>Controls Modernization – a series of controls modernization projects are underway and scheduled to be completed in phases. One major phase, MP-30 Controls Modernization, is complete. Listed below are the benefits of the modernization projects in respect to flare minimization.</p> <ul style="list-style-type: none"> • Provides for enhanced diagnostic tools (i.e. graphics of unit operation are much more visible and easy to follow) in units where Distributed Control Systems (DCS) are not currently in place (MP30 & Sulfur Recovery Units). • Reduction of control system instrumentation failures due to upgrade from old, pneumatic technology. This will result in much better reliability of the controls. • Increases unit stability and minimizes unit upsets. • Improves operator performance by incorporating Abnormal Situation Management practices such as alarm management and graphic guidelines. Alarm management is a philosophy which prioritizes alarms and minimizes the amount of alarms an operator must respond to in an abnormal situation. This prevents an operator from being overloaded with alarms and helps the operator focus on the immediate issues which must be remedied. • Use of human factors in information processing in order to communicate information in a proven, consistent, simplified, meaningful way. <p>Early event detection to reduce abnormal situations which might cause an upset.</p> <p>Installation of state of the art Safety Instrumented Systems (SIS) that will minimize spurious trips. Overall, the Controls Modernization will reduce flaring by minimizing upsets that can occur with the current controls in place. Improving the way that operators interface with controls allows them to prioritize their response to abnormal situations. This can result in more rapidly mitigating an unusual situation and minimizing overall impacts. One example would be by upgrading field tags (which are monitoring devices for operating parameters such as pressure or temperature, currently only visible in the field) to a tag which can be monitored in the control room. For example, if an equipment shutdown occurs and the parameter which shut the equipment down is a field tag, the modernized control system will more rapidly pinpoint the cause of the shutdown. The upgraded field tag would now be able to be seen rapidly by the Board Operator which will assist in restarting the piece of equipment more rapidly. This will reduce flaring.</p>
Processes:	

<i>Planned Actions for Reducing Flaring</i>	
<i>Planned Date of Installation/ Implementation</i>	<i>Equipment Item to be Added, Process to be Changed or Procedure to be Implemented</i>
On-going	<p>Improved Incident Analysis Investigation – Continue to complete required 12-12 Root Cause analysis and analysis triggered by internal incident investigation drivers. Investigations and corrective actions identified will continue to address issues that may result in flaring if not otherwise addressed. The root cause analysis requires that the facility find the actual cause of flaring, down to a single part that may have failed in some instances. The 12-12 analysis also requires the facility to identify changes that can be made to prevent flaring and list those in the root cause analysis submittal to BAAQMD. This results in the facility taking action to prevent recurrence of flaring events. For example, some of the recent root cause analysis have identified equipment upgrades that should be made, additional training to be conducted, equipment repairs, etc.</p>
Evaluation by 1 st Qtr 2012	<p>Fuel Gas Combustion Sulfur Dioxide Emissions –Determine feasibility of obtaining new Sulfur Dioxide (SO₂) limits for the refinery combustion sources through possible permit modification. This would allow greater percentage of refinery fuel gas to natural gas to be fired in the turbines. By revising the site emission limits it is possible that most flaring during periods of fuel gas imbalance could be eliminated while reducing overall combustion emissions. Historically fuel gas imbalance occurred during major Unicracker turnarounds when 30% of fired duty sources are shutdown. Discussions were previously held with BAAQMD permit engineers in 2007 to review the benefits and potential permitting mechanisms for repermitting SPP. Additional discussions will need to be held to discuss a site wide approach. The strategy for this permitting needed to be reassessed after bringing on the new unit and use of the third-party hydrogen plant during 3rd Quarter 2009. Internal work is actively continuing on this assessment.</p>
Maintenance:	

<i>Planned Actions for Reducing Flaring</i>	
<i>Planned Date of Installation/Implementation</i>	<i>Equipment Item to be Added, Process to be Changed or Procedure to be Implemented</i>
On-going	<p>G-503/G-540 Flare Gas Recovery Compressors - this practice began more than 5 years ago and continues to date. Approximately every 18 months, in association with a major unit turnaround, the G-503 Flare Gas Recovery Compressor is taken out of service for a major overhaul. The purpose is to maintain critical equipment associated with the compressor in order to prevent unplanned failures. This practice minimizes overall downtime for the compressor. The work is scheduled with a major turnaround since gasses produced at the facility are at reduced rates and many fuel gas consumers are out of service. Without this maintenance it is more likely that the compressor would experience unplanned failures during periods when high gas volumes are being produced. The unplanned failure repair is of longer duration because the personnel and equipment must be assembled without advanced planning. In many cases, diagnosis must be performed to determine the failure and this can take considerable time. Whereas, planned maintenance prevents many of these types of failures from occurring. As with regular maintenance on a vehicle, this maintenance performs a similar purpose.</p> <p>Now that the new Liquid Ring Flare Gas Recovery Compressor has been installed all flare gas recovery compressors will be maintained on a routine basis yet it will be done when the spare compressor(s) are in operation which will further reduce overall flare emissions.</p>

4.0 Prevention Measures (401.4)

4.1 “Major” Maintenance Activities (401.4.1)

This section discusses refinery maintenance and turnaround activities, outlines measures to minimize flaring during both preplanned and unplanned maintenance activities. A description of flaring that occurs during major maintenance activities is included in this section and in the section titled “When Flaring is Likely to Occur” in accordance to 401.4.1. As required by 401.4.1 a review of flaring associated with major maintenance has been conducted and is referenced below. The measures taken to prevent flaring during portions of major maintenance activities are included in the section titled “Measures to Minimize Flaring During Preplanned Maintenance”.

4.1.1 Refinery Maintenance and Turnaround Activities

Maintenance activities often result in a higher than normal flow of material to the flare gas recovery system. In order to maintain process equipment, the first step is to clear the process equipment and associated piping of hydrocarbons, before the system is opened to the atmosphere, for both safety and environmental reasons, including compliance with BAAQMD Regulation 8 Rule 10, (Process Vessel Depressurization). How this is accomplished depends on the physical properties of the hydrocarbons to be removed (vapor pressure, viscosity) and on the process details of the equipment that is to be maintained.

The first step is to recover as much of the hydrocarbon as is possible by transferring it to a process unit that is not in the part of the refinery that is being prepared for maintenance. For example, liquid hydrocarbons can be pumped to tankage or another process system; gases under pressure may be depressurized to another process unit. Heavy hydrocarbons that are viscous at ambient temperatures are often displaced from the equipment to be maintained using lighter hydrocarbons, e.g. diesel type material. This material can then be pumped from the equipment.

Although depressurization and pump-out can be used to remove the bulk of the hydrocarbon from the equipment, they leave some residual material. Following pump-out or depressurization to other process equipment, the next step in decommissioning typically requires a low-pressure location that has the ability to accept a wide range of hydrocarbon materials in order to avoid putting these materials to the atmosphere. The flare gas header is the only location within the refinery that meets these criteria. Equipment items containing materials that are gases at ambient temperature and pressure are often vented to the flare gas recovery system so that the hydrocarbon can be recovered as fuel gas. To free the equipment of hydrocarbons following depressurization, they can be purged using an inert gas such as nitrogen. Alternatively nitrogen can be added to the equipment increasing the internal pressure. The resulting mixture of nitrogen and hydrocarbon can then be released to the flare header, reducing the pressure in the equipment. Steam can be substituted for nitrogen in some cases, but not for processes that need to be kept dry in order to avoid corrosion or catalyst damage, or for some other reason.

For equipment containing liquids, often steam or nitrogen are used to “blow” the liquid to the flare header. The liquid hydrocarbon and condensed steam are separated from the vapor phase and returned to the refinery’s recovered oil system and to wastewater treatment either at the unit knockout

drum or at the flare knockout drum. Nitrogen with hydrocarbon vapor continues on to flare gas recovery. Once the bulk of the liquid hydrocarbon has been displaced, the flow of steam or nitrogen is continued to remove any residual hydrocarbon by vaporization. Steam can be more effective for heavier materials as it increases their volatility by increasing temperature. Proprietary solvents such as “Zyme-flow” are sometimes used in aqueous solution for removal of residual hydrocarbons. When aqueous solvents are used, they are typically circulated in the equipment and then treated.

Although these procedures eliminate hydrocarbon emissions related to equipment opening, they require a high volumetric, high velocity, steam or nitrogen flowrate in order to be effective. This high flowrate of inert gas can create several sets of circumstances where flare gas recovery is not feasible. These problems relate either to the change in fuel gas composition (increased molecular weight or temperature) or to the increase in volumetric flowrate.

In addition to an increase in flare gas average molecular weight from higher than normal nitrogen flowrate, there is also the potential for much lower than average molecular weight gas from increased flow of hydrogen. There are many process and reactor systems within a refinery that contain gases with a high hydrogen content. When this equipment is decommissioned by depressurization to the flare gas header, there can be a sharp decrease in the flare gas average molecular weight.

Effect of Flare Gas on Downstream Equipment

Gas composition affects the equipment in the flare gas recovery system. Specifically:

- High nitrogen content can impact heaters, boilers and the flare gas compressor.
- Hydrogen and other low molecular weight gases impact flare gas compressor performance.
- Steam impacts knock out drums and compressors.

High flows of nitrogen from equipment purging leads to a much higher than normal inert content in the recovered flare gas, greatly reducing its fuel value (measured as Btu/scf) and increasing its molecular weight. Reciprocating compressor (G-503) increase the pressure of a constant inlet volumetric flowrate of gas. For a given volume of gas, an increase in molecular weight creates an increase in its mass. This increases the work that the compressor has to do to compress the gas, overloading and potentially damaging the machine.

For a reciprocating compressor, the compression ratio (ratio of outlet pressure to inlet pressure) is high enough that more than one stage of compression is needed. The temperature of the gas increases as it is compressed. The gas is cooled between stages in order to control the temperature increase. Operation of a reciprocating compressor with a feed stream that has a molecular weight outside of the range for which it was designed (e.g. high hydrogen content) can lead to a temperature increase exceeding the design limitations of the machine. Flare Gas Compressor (G-503) is shutdown in order to protect it from failure that could be caused by a decrease in molecular weight.

The Liquid Ring compressors are expected to have a wider range of operating conditions. The compressors and associated control system will have enhanced monitoring in comparison with the existing Reciprocating Compressor. There will still be limitations on the type of gases that should be recovered and utilized in the fuel gas system (i.e. high volumes of hydrogen potentially impacting Btu values).

Additionally, if low Btu flare gas is transferred to the fuel gas header, the lower fuel value can have the effect of reducing combustion efficiency, as the combustion device burners are designed to operate

with fuels that have higher heat content per cubic foot. In extreme cases, the heating value of the gas can be reduced by dilution with nitrogen to the point of extinguishing the burner flame. This creates the potential for unburned fuel to accumulate in the heater or boiler, potentially leading to an explosion when it is re-ignited. NFPA 85 – Boiler and Combustion Systems Hazards Code and NFPA 86 Standards for Ovens and Furnaces warn against this possibility.

A major advantage of using steam to clear hydrocarbons from equipment is its elevated temperature; however this can be a disadvantage with respect to flare gas recovery. When the distance the gas must travel to reach the flare gas compressor is large, (the flare header is long), the gas will cool, and much of the steam will condense and be removed as water at the knock-out drum. However; with a shorter flare line or a long-duration steam out event, the temperature of the flare gas at the flare gas compressor can be elevated significantly. If the temperature of the flare gas stream at the inlet to the flare gas compressor exceeds machine limits, the gas must be diverted away from the compressor inlet in order to avoid mechanical damage.

Summary

Each of the situations described above potentially leads to the need to divert gas produced during refinery maintenance away from the flare gas recovery compressor and to a flare. This is a necessary result of maintenance procedures which have been adopted to minimize the release of hydrocarbons to the atmosphere during equipment opening. The need to divert gas is driven by the quantity and composition of the gases produced during equipment shutdown and startup.

Major maintenance activities can result in flaring, as discussed above. A review of maintenance-related flaring from 2000 to 2006 at the ConocoPhillips San Francisco refinery in Rodeo has been completed. See Attachment D for list of flaring due to planned and unplanned unit shutdowns or startups during that time frame. Attachment D has been marked **Business Confidential**. Due to the requirement to install flowmeters and report flare emissions to BAAQMD the data from September 2003 to date is the most accurate for this review. Subsequent flaring taking place during equipment startups and shutdowns are being examined as part of the Turnaround Planning Flare Minimization Process and causal analysis being conducted.

Based on the review there were means of further reducing and/or eliminating flaring that were identified. Included below is a summary of the measures identified and rationale for the acceptance or rejection of the concept:

Major Maintenance Prevention Measure Evaluation

This is a list of prevention measures that were identified based on the 5-year look back of Major Maintenance activities. Attachment D (Confidential) contains a list of the Major Maintenance events. Attachment H is a summary of all flaring events and is grouped by category. Based on the 5-year look back the following types of flaring were identified for elimination:

- Flaring associated with Hydrogen Unit Startups/Shutdowns (H2 SU/SD)
- Flaring due to G-503 Flare Gas Recovery Compressor Planned Maintenance (G-503 PM)
- General Flaring Associated with Major Maintenance (.e.g. nitrogen purging, steaming, etc.) (General)

Major Maintenance – Prevention Measure Evaluation					
Measure Description	Schedule for Implementation	Rationale to Support Schedule	Type of Flaring that would be Reduced or Eliminated	Rationale for Rejecting Measure	Section Reference <i>(for more details)</i>
Addition of Unit 110 Hydrogen Vent	<ul style="list-style-type: none"> • Phase 1: Dec. 2006 • Phase 2: Deferred due to U110 SU changes 	Phase 1 will install a vent which will allow a small stream of purified hydrogen to be vented. Phase 1 has been installed. Phase 2 will modify the existing vent to allow for higher volumes of hydrogen. A permit must be submitted and approved before vent installation. At this time Phase 2 is under new evaluation due to the reduction in duration of flaring.	H2 SU/SD	n/a	3.2
Odor Abatement/Flare Gas Recovery System Optimization	<ul style="list-style-type: none"> • October 2008 – Construction Start • August 2009 (completed) 	A set of 3 Liquid Ring Compressors were installed in order to provide redundant and extra capacity for the Flare Gas Recovery compressor. This will eliminate some flaring events that have historically occurred by having additional flare gas recovery service. A separate odor abatement compressor was installed which will provide further reliability	G-503 SU/SD G-503 Brief Peak Loading	Completed	3.2

Major Maintenance – Prevention Measure Evaluation					
Measure Description	Schedule for Implementation	Rationale to Support Schedule	Type of Flaring that would be Reduced or Eliminated	Rationale for Rejecting Measure	Section Reference <i>(for more details)</i>
		for the odor abatement system.			
Turnaround (T/A) Planning Procedure	4 th Qtr 2006	Being coordinated with submittal of Flare Minimization Plan.	H2 SU/SD G-503 PM General	n/a	4.1.3
Shutdown & Startup Activity Extension	4 th Qtr 2006	This will be included as part of the T/A Planning Procedure. In some cases flaring may be eliminated or minimized by extending the period that a unit is going through shutdown or startup. An example would be to nitrogen (N ₂) purge equipment at a lower rate so the G-503 Flare Gas Recovery Compressor can handle the excess N ₂ . More importantly, the safest operating conditions for a unit are when it is out of service or when it is running at normal conditions. The transition period, which occurs during startup and shutdown, requires special attention and procedures. Equipment placed under these conditions experience temperature and pressure changes which can result in hydrocarbon leaks. Due to these factors it is necessary to minimize the duration of transition periods.	General	To be included as part of T/A Planning Procedure process. This will not be utilized in each case due to transitional activity concerns.	4.1.3
Rate Reduction / Unit Shutdowns	4 th Qtr 2006	This will be included as part of the T/A Planning Procedure process. In some cases flaring may be eliminated or minimized through reducing rates or	General	To be included as part of T/A Planning Procedure process.	4.1.3

Major Maintenance – Prevention Measure Evaluation					
Measure Description	Schedule for Implementation	Rationale to Support Schedule	Type of Flaring that would be Reduced or Eliminated	Rationale for Rejecting Measure	Section Reference <i>(for more details)</i>
		<p>shutting down units. The implications of shutting down a unit must be examined for each case. For example, shutting down additional units may result in more fuel gas imbalance (i.e. production of more gas than can be consumed). The refinery units are interrelated so shutting down one or two units will result in impacts to other units. In some cases a number of units must be shutdown in association with a particular unit. In order to properly shutdown units they must be depressured and purged. This typically results in flaring. So, the shutdown of associated units doesn't reduce flaring in all cases and must be evaluated for the overall benefit on a case by case basis.</p> <p>Rate reduction is typically only of potential value if refinery is out of fuel gas balance. See Section 4.1.2 for the steps taken to mitigate fuel gas imbalances, including rate reduction. Some units may be an overall fuel consumer so reducing rate may not be helpful. The benefits need to be examined on a case by case basis.</p>		It is not beneficial to use this for all situations as described in the previous column.	
Implementation of Prevention Measures Identified during Causal Analysis	3 rd Qtr 2005	Prevention Measures are identified during the required BAAQMD flare event Causal Analysis reporting. These measures are then implemented to reduce flaring.	Various	n/a	3.1

Major Maintenance – Prevention Measure Evaluation					
Measure Description	Schedule for Implementation	Rationale to Support Schedule	Type of Flaring that would be Reduced or Eliminated	Rationale for Rejecting Measure	Section Reference <i>(for more details)</i>
Reporting		Note: General programmatic prevention measures identified will be listed in this section during Annual updates. Equipment specific prevention measures have been added to Attachment H.			
Identification of Cause of Small (<500,000 SCFD or <500 lb SO2) Flaring Activity	1 st Qtr 2007	Conduct regular meetings with Operation personnel who are responsible for the flare operation to identify causes of all flare activities.	Various	n/a	3.1
Storage, Treatment, Recovery Scenario 1 – Addition of New 1.5 MMSCF/D Compressor	n/a	n/a	G-503 PM (portion) General	Determined not to be cost effective.	4.2.2.1
Storage, Treatment, Recovery Scenario 2 – Addition of New 6.0 MMSCF/D Compressor	n/a	n/a	G-503 PM General	Determined not to be cost effective. However, a set of three new Flare Gas Recovery Compressors are being installed in conjunction with the Clean Fuels Expansion Project.	4.2.2.1
Storage, Treatment, Recovery Scenario 3	n/a	n/a	H2 SU/SD	Determined not to be cost effective. Technological,	4.2.2.1

Major Maintenance – Prevention Measure Evaluation					
Measure Description	Schedule for Implementation	Rationale to Support Schedule	Type of Flaring that would be Reduced or Eliminated	Rationale for Rejecting Measure	Section Reference <i>(for more details)</i>
& 4 – Addition of New High Pressure Storage Sphere, Compressor, & Amine Treater			G-503 PM General	operability, and safety feasibility not yet determined. It is likely that upon further study cost effectiveness will be further diminished. Operability and feasibility of safe operation of such a system may also pose a challenge.	

Section 4.1.2 contains a list of measures that are currently in practice for reducing flaring.

From this review it is clear that one of the greatest potentials for achieving further cost-effective reductions in flaring lie in maintenance planning with flare minimization as a goal coupled with the existing goals of safety and minimizing production impacts due to extended downtimes. The essential component of any plan that satisfies maintenance needs while minimizing flaring is that it must mitigate or eliminate the conditions described in the sections above that make recovery of flare gas impossible. In practical terms this means taking a series of actions specific to the unit being decommissioned to limit the rate at which flare gas is generated and maintain its temperature and composition within a range acceptable for transfer via a flare gas compressor and for use in the fuel gas system. Concepts for accomplishing this are discussed in the section following.

4.1.2 Measures to Minimize Flaring During Preplanned Maintenance

In accordance with 401.4.1 in regards to feasible prevention measures that can be used to minimize future flaring: (including that related to scheduled process unit turnarounds and immediate near-term shutdowns) are listed below. Numerous prevention measures are utilized to prevent flaring from occurring during portions of major maintenance events. The information is organized by process unit and by topic. There are also some general measures listed that are used at most units, when applicable. Refer to Attachment E for list of unit names and numbers. It is noted that although prevention measures are routinely employed, as explained in the previous section, all flaring cannot be eliminated due to gas quality and quantity issues associated with major maintenance activities.

Hydroprocessing (U228, U229, U230, U231, U240-2, U244, U248, U250)

Hydroprocessing units are depressurized to hydrogen recovery, or other lower pressure locations such as a hydrogen vent (U240-4), and only after this are they depressurized to flare gas recovery, reducing the load on the flare gas recovery system. This prevents flaring by minimizing load on the flare gas recovery system and decreases the period of time in which flaring occurs during venting activities.

Following depressurization, the remaining hydrocarbon is removed by increasing the pressure in the equipment with nitrogen and then depressurizing it to flare gas recovery multiple times. Doing this quickly helps with mixing, which improves removal of hydrocarbon from the vessel so that fewer cycles are needed. This minimizes the volume of low quality gasses that are sent to the flare.

Depressurization of the unit to the flare gas recovery system is staged in order to minimize exceeding the capacity or quality parameters of the system in order to maximize the time in which the flare gas recovery compressor is on-line. The longer the flare gas recovery compressor is on-line the less flaring that occurs.

Gases are recirculated using the hydrogen recycle compressors as the reactors cool. When the equipment is cooled and at low pressure, nitrogen pressurization and release steps are used to clear hydrocarbons. Hydrogen-containing streams are directed to the hydrogen plant. Use of hydrogen recycle for cooling and cleaning minimizes the need for nitrogen which, when utilized, typically results in flaring.

U250 - A high pressure hydrotreater design is used to avoid flow to the flare by containing the process during loss of utilities. Without this design, additional volume of materials would be sent to the flare during loss of utilities. See Section 3.1 for more details on elements of this design.

Reformer (U231, U244)

The timing of the steps involved in the regeneration cycle are controlled and the venting / depressuring rate limited to be within the capacity of the compressors. This minimizes the total vent stream that must be sent to the flare.

Delayed Coker (U200)

The delayed coker drum cooling cycle time is coordinated with other activities to prevent exceeding the Flare Gas Recovery Compressor capacity.

Hydrogen Plant (U240-4)

During startup and shutdown of the Unit 240 hydrogen plant the hydrogen can be routed directly to the flare, allowing recovery of routine flare gases from other units during this period. If this hydrogen was routed to the refinery blowdown system associated with the G-503 Flare Gas Recovery Compressor the compressor would need to be shutdown. This minimizes flaring by reducing the total amount of gasses that must be sent to the flare. Additionally, Hydrogen is a process gas with minimal impurities, thus the flaring of Hydrogen versus all blowdown gasses reduces emissions of hydrocarbons and sulfur dioxide.

Fractionation Units (Various units, throughout refinery)

Vents from depressurization of fractionation units are recovered using the flare gas compressor system rather than being routed to the flare, when capacity is available or gas quality allows. This minimizes flaring by reducing the volume of gasses that must be sent to the flare.

Compressor (U200 Flare & Blowdown System)

Compressor Maintenance

In some instances, the flare gas recovery compressor (G-503) is placed in wet gas recovery compressor service (G-501) if the wet gas compressor is expected to be offline. This minimizes the total amount of gas flared. A greater volume of gas can be recovered by placing G-503 directly in Wet Gas service rather than directing the Wet Gas into the blowdown system. Recovering higher rates of gas reduces the volume recovered.

Flare gas compressors are maintained during planned unit shutdowns, to improve reliability during periods of normal operation. A planned shutdown provides an opportunity to do maintenance while flare system load is lower.

In the future, when the redundant new Liquid Ring Flare Gas Recovery Compressors are operational planned maintenance scheduling will be optimized and staggered to minimize and/or prevent flare gas recovery outages for compressor maintenance.

Regular preventative maintenance of flare gas compressors, as described further in Section 3.2, is used to improve their reliability.

Maintenance is also conducted on compressors based on critical monitoring (i.e. vibration, temperature, load) results.

Flare System Monitoring

Flare Gas Recovery Compressor load is monitored to identify & mitigate higher than normal baseline load. High loads are mitigated by identifying the source and making reductions. For example, if a PRV is venting to blowdown then the responsible unit will be identified and directed to make adjustments to prevent the PRV from venting.

The flare gas recovery compressor is monitored when maintenance is being conducted at other units that will cause the compressor to be taken off-line. The purpose is to minimize the amount of compressor downtime in order to protect the compressor and minimize the total time the compressor is shutdown and reduce overall flaring.

Plant personnel who oversee flare gas recovery systems have been instilled with an improved understanding. The operators monitor flare gas compressor load to check for high load or load changes, record instances of flaring and potential causes, take action to minimize flaring, and notify Shift Superintendents when flaring occurs. This results in conscious management of the flare system to minimize flaring.

Flow and/or temperature measurement as a means of indicating flow in each flare header is used to identify and eliminate sources of flow to the flare gas header. Indication of flow during periods when flow is not expected is a direct indication of flaring. As described above, operators respond to flaring events by attempting to track the source and working with the Shift Superintendent to take action to make reductions or eliminate flaring.

The monitoring parameters available for the Liquid Ring Compressors will be more robust and provide more on-line indication of changes in flare gas quality. This enhanced monitoring will likely assist in the optimization of compressor on-line performance.

On-line diagnostic tools are utilized to monitor flows to the flare in order to minimize flaring duration. See Section 3.1 "Operational Improvement – Monitoring" for more details on how these tools reduce flaring.

When higher than normal flare gas recovery compressor loads are detected announcements are made throughout the refinery in order to proactively identify and address the source of gases. See Section 3.1 Emergency Operating Procedure EOP-1 "Guidelines for Standard Public Address System Announcements" for more details.

Fuel Gas Scrubbing

Gases collected by the flare gas compressor are scrubbed whenever possible. This includes periods of fuel gas imbalance and periods when the compressor capacity is exceeded but the compressor is still operational. This results in reduced sulfur dioxide emissions from the flare.

Sulfur Recovery Units (U234, 236, & 238)

The refinery has three sulfur recovery units operating in parallel. During periods of maintenance the load is shifted from one unit to the others. Thus, no flaring is necessary during unit startups or shutdowns. Additionally, sulfur load can readily be reduced by decreasing sour water stripping. The Refinery has not historically experienced acid gas flaring during sulfur plant startups & shutdowns or upsets.

General Measures (used at various units, as applicable)

Liquid Vessel Cleanup

Chemical cleaning is used so that cleanup is faster, minimizing the time needed for steam out. Chemical cleaning works similar to using dish soap on greasy dishes in that cleaning time and rinse water is minimized. Thus, in practice overall time in which steaming must occur is minimized, thus minimizing flaring. Chemical cleaning is primarily used in units where there is a high volume of residual oil and solids in equipment and piping. Chemical cleaning must be balanced with wastewater treatment plant capabilities.

Depressurization

Separate flare gas headers are in place at the Unicracker Complex for the Reactor section and Hydrogen Plant so that some gases produced during maintenance, startup, and shutdown can be directly routed to the flare. This minimizes the volume of gases sent to the flare during maintenance activities since it provides a separate system from the refinery blowdown system. This allows a portion of the refinery gasses to be recovered while only those from the Unicracker are sent to the flare.

Pressure Relief

Routine maintenance of PRDs, consistent with API 510, is used to minimize "routine" flow to the flare gas header. The purpose of the maintenance is to ensure the PRDs are operating properly at the appropriate set points and not relieving prior to the intended set point. Proper operation of PRDs provides a safe operation, reduces the base load and allows the system to better able to handle flow peaks during maintenance or other periods where there is additional flow in the blowdown system.

Source Reduction

If there are indications of increased base load to the flare gas compressor efforts are taken to identify and mitigate or minimize the source of gasses. This is done by identifying the flare header affected by use of monitoring parameters, as available, such as flare header flow meters, pressure and temperature indicators.

Shutdown/Startup Planning & Scheduling

A specific plan will be developed to minimize flaring during each turnaround, as each is unique. Specific actions depend on which parts of the unit are being brought down and which other units are down at the same time. Note: Historically this has taken place for major turnarounds, this will be expanded to minor turnarounds as well.

Specific "flare planning" has been conducted in respect to major turnarounds.

Plans have been prepared to insure there will be a viable fuel balance during each time period during the shutdown.

The length of the shutdown has been extended in some cases to allow equipment to be purged at lower rates that can be handled by the flare gas recovery system. Extension of shutdown length will be considered as part of the turnaround planning procedure referenced in Section 2. There are limitations to this activity. The safest operating condition for a unit is either when it is out of

service or when it is running at normal conditions. The transition period, which occurs during startup and shutdown, requires special attention and procedures. Equipment placed under these conditions experience temperature and pressure changes during the transition period which can result in hydrocarbon loss. Due to these factors it is necessary to minimize the duration of transition periods.

Rate Reductions and Unit Shutdowns at interrelated units occur to balance inventory. This will be included as part of the T/A Planning Procedure process referenced in Section 2. The implications of shutting down a unit must be examined for each case. For example, shutting down additional units may result in more fuel gas imbalance (i.e. production of more gas than can be consumed). The refinery units are interrelated so shutting down one or two units will result in impacts to other units. In some cases a number of units must be shutdown in association with a particular unit. In order to properly shutdown units they must be depressured and purged. This typically results in flaring. So, the shutdown of associated units doesn't reduce flaring in all cases and must be evaluated for the overall benefit on a case by case basis.

Rate reduction is typically only of potential value if refinery is out of fuel gas balance. Again, the big picture needs to be examined. Some units may be an overall fuel consumer so reducing rate may not be helpful. The benefits need to be examined on a case by case basis.

Load shed planning is used to keep the fuel gas system in balance as units come up/down. Following the turnaround, any flaring that did occur is reviewed and a list of lessons learned is developed in order to minimize flaring during future turnaround events. Note: This is a minimization effort that is being instituted in a more rigorous manner as part of this FMP. This consistently applied review will help establish successful flare minimization practices that can be utilized in the future.

Shutdown activities are staged to keep the rate to the flare gas compressor low. This will be considered on a case by case basis as part of the turnaround planning procedure referenced in Section 2 which addresses flare minimization.

Turnarounds are scheduled so as to bring some units down every year, so that not all units are down at any one time.

Turnarounds are scheduled to minimize downtime associated with the unit and to provide a window for conducting preventative maintenance in order to promote equipment reliability. Conducting turnarounds on a regular basis prevents unplanned shutdowns that can lead to long periods of flaring if the necessary equipment is not available to quickly remedy a failure.

The duration between turnarounds is being extended over time as technology improves in order to minimize production impacts. This also results in minimizing flaring over long periods of time (i.e. 5 – 10 year windows). The reason this reduces flaring is that the number of turnarounds in a 10 year period is reduced if the duration between turnarounds is extended. Eliminating one or two turnarounds in a 10 year period will eliminate the flaring associated with the startup and shutdown activities. The duration between turnarounds is being extended due to improvements such as longer catalyst life, better unit monitoring, better metallurgy, enhanced inspection technology and procedures.

Shutdown and Startup Execution

Equipment is purged slowly to avoid overloading flare gas recovery system capacity. The minimum purge rate that can be achieved is limited by the need to prepare the equipment for

maintenance. This will be evaluated as part of the turnaround planning procedure referenced in Section 2.

Cleanup activities are cascaded so that large amounts of nitrogen are not routed to the flare at any one time. If all equipment was purged with nitrogen simultaneously this would likely overwhelm the flare gas recovery compressor. By cascading the purging, this allows the flare gas recovery compressor to recovery gasses to blowdown during a longer period of time, thus minimizing overall flaring since the compressor has been kept on-line for a longer period of time.

Steam is used instead of nitrogen for equipment clearing, as much of the steam condenses reducing the load on the flare recovery system. Steam is typically used in cases where there are not equipment vacuum limitations (e.g. piping, small equipment). Vessels typically have vacuum limitations. During steamout the peak flow to the flare gas recovery system is minimized by monitoring the steam rate and cutting back if the rate is too high. This does not eliminate all flaring associated with steamout procedures but minimizes the total amount of flaring.

The molecular weight of the flare gas is monitored, so that it is diverted away from the flare gas compressor when approaching outside of parameters that it can handle or that is suitable for combustion in unit heaters and boilers. This minimizes flaring by optimizing the period in which the compressor is on-line while also protecting the compressor from an equipment failure. Feed and product compressors are used to recycle material during startup until product specifications are met, allowing flaring to be avoided. The alternative would be to send gasses that have run once-through the reactors directly to blowdown. This minimizes the load to the flare gas recovery system and eliminates the potential for flaring.

Communication Measures

There is coordination from operator to operator and coordination within the shift organization so that the flare gas compressor load is not exceeded. The operators call to check on compressor operation before initiating actions that increase vent load.

Fuel Gas Balance

The fuel balance is adjusted to avoid flaring. This is done by examining the fuel gas balance which contains fuel producers and consumers. Depending on the environmental, safety and process constraints, operational changes are made dependent on which units have the most impact to the balance and the most flexibility. Reductions in fuel consumption or increases in consumption are attempted at numerous locations in order to get the facility back into fuel gas balance.

Steps taken to prevent fuel gas imbalances include and are generally included in the order of potential impact are:

- Minimize or cease butane vaporization to fuel gas.
- Increasing fuel consumption at operating heaters.
- Increasing production (i.e. fuel consumption) at Co-Generation plant.
- Operating steam turbines rather than electric drivers for pumps and compressors.
- Adjust the fuel supply at the Co-Generation plant to back out purchased natural gas and use more refinery fuel gas.
- Adjusting the severity of unit operations to affect the rate of gas production.
- Reducing process unit rates to decrease fuel gas generation.

The Refinery is also reviewing an application of a permit modification to address the short term SO₂ limit at the Co-Generation plant that restricts fuels gas consumption. Removing that restrictive limit will significantly reduce flaring from a fuel gas imbalance.

If a fuel gas imbalance does occur gasses are typically scrubbed for hydrogen sulfide removal. Excess clean gasses are then flared while additional measures are taken to mitigate the imbalance.

Reliability

The reliabilities of ancillary systems which can lead to flaring if they trip have been improved, reducing flaring. See the "Maintenance Excellence Philosophy" portion of Section 4.3.2.1 for more details of the facilities reliability practices.

Incident investigations, as further described in Section 3.1 and 3.2, are utilized to determine root cause of failures and determine appropriate corrective actions to prevent recurrence.

Maintenance is conducted on compressors based on critical monitoring (i.e. vibration, temperature, load) results.

Preventative maintenance is conducted on critical pieces of equipment (pumps, compressors, etc) throughout the refinery to prevent failures. The benefits described for Flare Gas Recovery Compressors in Section 3.2, preventative maintenance conducted on critical equipment serves a similar purpose. Planned maintenance prevents failures. Equipment failures can often lead to flaring if a unit experiences an upset or must be shutdown. By conducting preventative maintenance, failures can be prevented which reduces flaring.

4.1.3 Turnaround and Maintenance Flare Minimization Planning Tool

A planning tool has been developed and will be used to minimize flaring associated with planned turnaround and maintenance events, incorporating the minimization concepts outlined above. The means in which it will be utilized is presented in Attachment F. Listed below is an overview of the elements contained in the procedure:

- Establishing a timeline for conducting the initial evaluation of when flaring may occur prior to the turnaround;
- Scoping of the flaring that is expected to occur;
- Checklist which has a list of elements which should be considered in respect to flare minimization techniques;
- Post turnaround review of flaring which occurred.
- Documentation of lessons learned during the turnaround & successful minimization techniques utilized.
- Incorporation of lessons learned into appropriate shutdown, operating procedures, facility documents.

This process will minimize flaring by requiring more planning to address flaring that may occur during a unit shutdown and turnaround. It will also cause personnel associated with turnaround activities to develop means to alter their work in order to take action to minimize flaring. Lessons learned will be captured and used for future turnarounds in order to continue efforts to minimize and/or eliminate flaring. See Section 3 **Turnaround Planning Flare Minimization Procedure** discussion for more detail.

4.1.4 Measures to Minimize Flaring During Unplanned Maintenance

There are occasions, primarily as a result of equipment malfunction, where a relatively immediate decision is made to shut down a block of the refinery, typically within a period of hours, allowing very little time for specific planning. In these cases, although the maintenance planning tool can still be used, it is often not possible to make the adjustments necessary to minimize flaring to the same extent as is possible when the shutdown is planned in advance. Despite this, there are many actions that can be taken to minimize flaring even when there is very little advance notice. For these cases, the refinery utilizes general procedures that have been developed to minimize flaring during all maintenance events, as shown in the attached flowchart. Although there is less of an opportunity for scheduling turnaround activities so as to insure that there will be a home for all of the gas generated at each step of the process, many of the same general principles apply when the decision to bring the unit down is immediate.

4.2 Gas Quality/Quantity Issues for Each Flare (401.4.2)

This section discusses when flaring is likely to occur due to gas quality/quantity issues, systems for recovery of vent gas, and options for recovery, treatment and use of flare gas in accordance with 401.4.2

4.2.1 When Flaring is Likely to Occur

Releases of vent gas to the flare result from an imbalance between the quantity of vent gas produced by the refinery and the rate at which it can be compressed, treated to remove contaminants (sulfur compounds) and utilized as fuel gas. Situations that can lead to flaring can be grouped together based on similarity of cause. These general categories, including specific examples of events which fit into each category, are outlined and discussed below as required by 401.4.2 in respect to flaring that may reasonably be expected to occur due to issues of gas quantity and quality:

4.2.1.1 Maintenance, Turnaround, Startup, and Shutdown

Generally, in order to maintain either an individual equipment item or a block of refinery equipment, it is necessary to remove it from operation and clear it of process fluids. Examples include:

- Unit shutdown
- Working on equipment
- Catalyst change
- Plant leak repairs
- Compressor system repairs (planned and unplanned)
- Unit Startup

Fuel and Hydrogen Gas Balance

All of these activities of necessity impact refinery operations in a variety of ways. In order to minimize the risk of flaring, there must, at all times, be a balance between producers and consumers of fuel gas. When either a block of equipment or an individual equipment item is removed from service, if it either produces or consumes gases, then the balance of the fuel gas system is changed and adjustments are necessary to bring the system back into balance. If the net change in gas production/consumption is large and adjustments in the rate at which gas is produced/consumed by other units cannot be made quickly enough, then flaring results.

Flaring also occurs during Hydrogen Plant startups, shutdowns, or when a downstream hydrogen user experiences a sudden outage. As previously described, flare gas recovery compressors cannot handle high volumes of hydrogen in the system. When a hydrogen plant has been shutdown it typically is shutdown with a hydrogen consumer. In order to properly startup the consumer unit the hydrogen must first be available. Therefore, hydrogen plants are started up initially and may not have an outlet for all the hydrogen being produced. If a vent is not available, the hydrogen is sent to the flare gas recovery system if the system can handle minor volumes, otherwise it is sent to the flare. Hydrogen is also utilized for downstream equipment sweeping, thus the hydrogen plant is typically shutdown after the downstream unit. Thus, for similar reasons to startup there can be hydrogen containing streams sent to the flare system. If a hydrogen consumer suddenly shuts down, in order to minimize overall facility impacts, the hydrogen plant is typically kept running, rates may be reduced, but excess hydrogen flared until the downstream unit is restarted. Specific examples of this effect and fuel gas balance issues are listed below:

- Fewer locations that can accept the gas due to equipment/units out of service
- Hydrogen plant startup/shutdown
 - Including Excess Hydrogen production following startup or unit shutdown
 - Temporary flaring of off-spec hydrogen during startup
 - Planned & Unplanned shutdowns can result in flaring
 - Planned & Unplanned shutdowns of the third party plant can result in flaring.
- Unicracker Complex turnaround (i.e. numerous combustion devices shutdown)

Equipment Preparation for Maintenance

Additionally, in order to clear hydrocarbons from equipment in a safe and orderly fashion so as to allow it to be maintained, a variety of procedures must be used. Many of these necessary procedures result in changes in the quantity and quality of fuel gas produced. For example:

- Depressurization of equipment
- Pressurization of equipment with nitrogen to remove hydrocarbon resulting in low fuel value (high nitrogen content) gas which cannot be used with burners designed for “normal” fuel gas, as there can be NO_x production and flameout concerns with low Btu gas.
- Steaming provides an efficient means for removing hydrocarbon clingage from equipment but the effects of steam (high temperature, condensation production) can result in the need to shutdown flare gas recovery compressors.

See the “Refinery Maintenance and Turnaround Activities” section for more details in regards to the reasons for flaring during equipment preparation for maintenance.

Preventative Maintenance, On-Line Planned Maintenance, Equipment Upgrades, Changes

In order to prevent unplanned failures preventative maintenance (PM) is conducted at varying schedules. Typically, PM is conducted to minimize production and/or environmental impacts by grouping PM activities together. Additionally, equipment upgrades occur periodically or changes may be made to improve existing systems. During equipment upgrades/changes pieces of equipment may be required to be taken out of service for brief periods of time to ensure worker safety and/or allow for equipment access.

Flare Gas Recovery Compressor Maintenance –

Major Maintenance - typically conducted in conjunction with the Unicracker Complex turnaround in order to minimize environmental impact (i.e. less gas being produced while the Unicracker Complex is shutdown). The purpose of the PM is to maintain the compressor in order to minimize unplanned failures. This results in better on-line efficiency. Unplanned failures typically require more downtime due to time needed to diagnose the failure and then acquiring the necessary parts to make repairs.

Minor Maintenance – Based on on-going monitoring conducted on the compressor, see Recurring Failure section for more details, minor maintenance is conducted to replace parts or equipment which may fail or is not operating per the design. Purpose of the maintenance is to minimize and control downtime by preventing an unplanned, uncontrolled failure which may

result in increased downtime. Additionally, the maintenance also can restore the compressor capacity and prevent flaring if the compressor is not functioning up to the equipment design.

Refinery Relief and Blowdown System Maintenance – Periodic maintenance is required on sections of the relief and blowdown systems (e.g. process vessels, drums, flare water seals, flare tips, etc.). This maintenance can include periodic, required metallurgical equipment inspections as well as preventative maintenance cleaning and replacement of components. These activities are required to prevent unplanned shutdowns which might incur long repair periods of not performed proactively.

Miscellaneous PM, Equipment Upgrades, Changes

Flare Gas Recovery System Maintenance - Construction tie-ins to the flare system, instrument changes, electrical upgrades, new equipment installations could require equipment to be taken out of service. This might result in flaring in order to isolate equipment and then also during equipment startup.

Equipment Upgrades / Changes - are made periodically to improve existing systems. This may require various pieces of equipment to be temporarily taken out of service. Portions of operating units or individual pieces of equipment may be taken off line for preventative maintenance or repairs. This can result in flaring during the clearing of equipment and flaring when equipment is put back in service.

On-Line Maintenance - Water washing of U244 D-506 and U231 D-105 Reformate Stabilizer is conducted periodically. The procedure is managed in order to minimize loading to the flare gas recovery system but there are periods when flaring may occur during this procedure.

4.2.1.2 High Base/Continuous Load

Although flaring is often the result of a sudden, short-term imbalance in the flare/fuel gas system, it is made more likely when the gap between the capacity of the flare gas recovery system and long term average flow to the flare header is reduced. Examples of base load to the flare header include:

- Leakage of relief valves
- Low pressure equipment vented to flare header, e.g. tower overhead systems
- Delayed coker depressurization
- Low pressure tankage or odor sources vented to flare header via blower or compressor
- Hydrocrackers and reformers at end of run with elevated gas production rates
- Accumulation of small actions each of which results in production of flare gas
- Seasonal issues with cooling water temperature resulting in increased rates to flare header
- Temporary re-rerouting of gases from other systems such as odor abatement to fuel gas recovery in order to prevent system overpressure.
- Feed quality issue resulting in temporary increased base load.

In cases of this type of flaring when the flare gas compressor is still operating the gasses recovered by the compressor will continue to be scrubbed for hydrogen sulfide removal at Unit 233.

4.2.1.3 Reduced Consumption of Fuel Gas

Treated flare gas may be flared during supply/demand imbalance. If flaring is to be minimized, it is necessary to balance fuel gas producers and consumers in the refinery. Refinery modifications that can change the fuel gas balance so as to make flaring more likely include:

- Energy efficiency projects that reduce fuel gas consumption
- Fuel gas imbalances can occur when fuel consumers (e.g. heaters, turbines) are shutdown and more gas is being produced than can be consumed.

4.2.1.4 Upset/Malfunction

An imbalance in the flare gas system can also result from any of a series of upsets or equipment malfunctions that either increase the volume of flare gas produced or decrease the ability of the fuel gas handling system to accommodate it. Examples include:

- Leaking relief valves, PRV malfunction
- Relieving relief valves
- Equipment plugging
- Loss of a major compressor (e.g. Wet gas compressor)
- Loss of flare gas compressors, including but not limited to:
 - Reciprocating compressor seats overheating from high nitrogen or hydrogen content
 - Fuel gas with low specific gravity (due to Hydrogen), or high heat of compression resulting in overheating
 - High inlet temperature to flare gas compressor
 - Monitored safety/protective parameter (e.g. vibration) triggered shutdown.
 - General mechanical problems inherent in the operation of rotating equipment.
 - High liquid level.
 - Equipment failure resulting in loss of compressor efficiency.
- Loss of other compressors (e.g. odor abatement, recycle hydrogen)
- Loss of a utility (steam, air, cooling water, power)
- Loss of air fins or condensers
- Failure of instrumentation, valve, pump, compressor, etc. to function as designed.
- Fuel quality upsets
- Hydrogen plant Pressure Swing Adsorption (PSA) operational changes (e.g. switching from 10 bed to 8 bed operation).
- Hydrogen plant PSA valve leaks resulting in a unit upset.
- Hydrogen may be sent to the flare system when there is a supply/demand imbalance.
- Unplanned/sudden shutdown of 3rd party Hydrogen Plant.
- Equipment failure which results in an immediate or controlled unit shutdown (e.g. charge pump failure)
- Feed quality issue resulting in unit upset. (e.g. wet feed, lighter than typical feed)
- Control system failures resulting in either unit shutdowns or unit not operating as efficiently in manual operating mode.
- The unit Hazard and Operability (HAZOP) studies contain more specific listings of potential causes of equipment malfunctions and upsets which may lead to flaring.

4.2.1.5 Emergencies

Equipment failures and operational issues that result in equipment overpressure, typically leading to relief valves opening to the flare system, are classed as emergencies. Emergency flaring events are severe instances of upsets or malfunction. Emergencies are further defined in BAAQMD 12-12.

- Line leak, fires due to leaking flanges, etc. can result in emergency unit shutdowns in which material from units is quickly sent to the flare.
- Unit Hazards and Operability Studies (HAZOPs) and Process Hazards Analysis (PHA) also reference emergency conditions which may lead to flaring. These studies are a systematic

evaluation of the hazards involved in the process. PHAs are required for initiation of a process, for major equipment/operating changes, and at least once every five years after that. One of the values of PHA's is to identify potential hazardous and develop means for mitigating hazards before they occur. For example, one of the ways to conduct this evaluation is to take unit piping and instrument diagram (P&ID). The consequences of failure of pieces of equipment (e.g. on a pump if flow is lost, flow is increased, flow is decreased) are discussed and the mitigation in place is reviewed. Where improvements should be made they are identified and tracked to completion. See Section 4.3.2.1 for more details about PHAs.

4.2.1.6 Miscellaneous

- Undetermined Cause - in some cases the cause of flaring cannot be determined. Typically, this is during minor flaring events (<500,000 scfd). Systems have been setup to try and pinpoint the cause of all flaring events, most events are traced back to a source but there are instances when a direct cause cannot be determined.
- Natural Gas Purge – flaring can occur if there is a spike in the natural gas purge flow. One of the ways this may occur is if the natural gas purge valve is opened too quickly or at a rate greater than typical flow. This results in the brief flaring of excess purge gas.
- False Flow Meter Reading – as previously described to BAAQMD, many parameters (e.g. water seal level, flare line pressure, flare tip cameras) are utilized to determine whether or not flaring has actually occurred. In some cases flow may be detected by the meter, for example due to thermal expansion, but not all other parameters indicate that flaring has occurred. This is a common issue due to the sensitivity of the ultrasonic flow meters.

4.2.1.7 Other Causes

There are many potential causes of flaring, some of which are exceedingly difficult to totally eliminate, despite careful planning and system design.

4.2.2 Vent Gas Recovery Systems

As required by 401.4.2 the following sections contain an audit of the vent gas recovery, storage, and treatment capacity. In addition, an evaluation for installing additional recovery, storage, or treatment equipment to recover portions of gases periodically sent to the flare.

Refinery unit operations both produce and consume light hydrocarbons. Most of these hydrocarbons are routed directly from one refinery process unit to another. Refineries are constructed with a network of flare headers running throughout each of the process units in order to allow collection and safe handling of any hydrocarbon vapors that cannot be routed directly to another process unit. The hydrocarbon vapors are collected at low pressures in these flare headers. These gases are recovered for reuse by increasing their pressure using a flare gas compressor system. The compressed gases are typically returned to the refinery fuel gas system for use in fired equipment within the refinery. Any gas not compressed and sent to the fuel gas system is routed to a flare so it can be disposed of safely by combustion under controlled conditions. A typical flare gas system is shown in:

See Attachment G. In order to recover flare gas for use in the fuel gas system, three criteria must be met. First, there must be sufficient flare gas compressor capacity. Second, there must be sufficient gas treating capacity. Finally there must either be available storage volume or a user (e.g. fired

heater) with a need for the gas. If any of these conditions are not met, then the gas cannot be recovered into the fuel gas header.

Existing Systems for Vent Gas Recovery

Within the [ConocoPhillips San Francisco Refinery at Rodeo, CA](#), the systems that currently exist for recovery of vent gas are described by the table below.

Flare System	Vent Gas Recovery Capacity (MM scfd)	Storage Capacity (MM scf)	Scrubbing Capacity for Vent Gas (MM scfd)	Total Gas Scrubbing Capacity (MM scfd)
Main Flare & MP30 Flare	4.75	None	None	35 ¹

¹ The facility does not have a scrubber for gases sent directly to the flare. The flare gas recovery system typically sends gases to U233 for H₂S removal and then sends these gases to fired sources. The capacity listed above includes the total capacity of the scrubbing system.

The [ConocoPhillips, San Francisco Refinery](#) vent gas recovery system does not include any dedicated capacity for storage of fuel gas or vent gas. However, on a continuous basis the refinery optimizes the refinery fuel gas system of producers and consumers to maximize the capacity available for treatment and reuse of recovered gases by employing the following strategies:

- adjusting the sources of fuel that are made up to the fuel gas system including imported natural gas, and butane;
- adjusting the operations of units that produce fuel gas range materials including at times reducing severity of operations to reduce fuel gas production if it would put the refinery in a flaring situation;
- adjusting the refinery profile for consumption of fuel gas by ensuring the cogeneration unit is at its maximum capacity (within constraints on exporting power), shifting rotating equipment to turbine drivers (which operate with steam generated in the fuel gas fired boilers), and at times reducing the throughput of processing units to minimize gas production. There are limitations to this activity. For example, the cogeneration unit has a sulfur dioxide (lb/hr) limit. The cogeneration unit utilizes a fuel mixture of refinery fuel gas (sulfur containing) and natural gas (nearly nil sulfur). As the ratio of refinery fuel gas is increased the units start approaching their sulfur dioxide limits. The amount of fuel gas burned in facility heaters is limited by permit conditions and energy efficiency constraints.
- When possible, the usage of fuel gas can be increased for brief periods of time to mitigate or prevent flaring.

The total gas scrubbing capacity that is indicated is an integral part of the refinery fuel gas management system. This capacity is closely matched with the fuel gas consumers' (heaters, boilers, etc.) usage requirements. The capacity indicated as being available for recovered vent gas scrubbing will vary depending on the balance between fuel gas production and consumption; it will vary both on a seasonal basis and during the course of the day. With this system for flare gas recovery in place, the ConocoPhillips San Francisco refinery at Rodeo, CA has recovered the following daily and annual average flow volumes:

Year	Daily Average Flare Gas Recovered (MMSCF/d)	Daily Average Flare Gas Flared (MMSCF/d)	% of Material Recovered	Annual Volume Flare Gas Recovered (MMSCF/Yr)	Annual Volume Flare Gas Flared (MMSCF/Yr)
2006 to date prorated	2.35	0.06	99%	858	22
2005	1.97	0.16	92%	722	58
2004	2.30	0.64	78%	850	234

Note: The amount of material flared and % of material recovered can be very dependent on the turnaround schedule. Major turnarounds are typically conducted less frequently than once per year. For example, a major turnaround of the flare system occurred in 2004.

4.2.2.1 Options for Recovery, Treatment and Use

To address the requirements of Regulation 12 Rule 12 (401.4), the [ConocoPhillips, San Francisco refinery at Rodeo, CA](#) has considered the feasibility of further reducing flaring through additional recovery, treatment, and/or storage of flare header gases, or to use the recovered gases through other means. This evaluation considers the impact these additional systems would have on the volume of flared gases remaining in excess of what has already been recovered (as noted in the previous section), and the associated mass flow of hydrocarbons emitted after combustion in the flare control device.

A typical flare header is connected to both a flare gas recovery system and to one or more flares. Normally all vapor flow to the flare header is recovered by a flare gas recovery compressor, which increases the pressure of the flare gas allowing it to be routed to a gas treater for removal of contaminants such as sulfur and then to the refinery fuel gas system. Gas in excess of what can be handled by the flare gas recovery compressor(s), the treater(s), and/or the fuel gas system end users flows to a refinery flare so it can be safely disposed of by combustion. Therefore, in order to reduce the volume of gas flared, three essential infrastructure elements are required: sufficient compressor capacity to increase the pressure of the gas to the point where it can be used in the refinery fuel system, sufficient storage volume to dampen out the variation in volumetric flowrate to the flare gas header, and sufficient capacity in treating systems to condition the gas (primarily by removal of sulfur) for use in the fuel gas system.

Options for storage of flare gas are analogous to those for storage of other process gases. Gases can be stored at low pressure in expandable gas-holders with either liquid (water) or dry (fabric diaphragm) seals. The volumes of these systems expand and contract as gas is added or removed from the container. Very large vessels, containing up to 10,000,000 cubic feet of gas can be constructed by using multiple "lifts", or stages. Gases can also be stored at higher pressures, and correspondingly lower volumes, in steel bullets or spheres. The optimal pressure vessel configuration depends on system design pressure and total required storage volume.

For any type of gas storage facility, selection of an acceptable site and obtaining the permits necessary for construction both present difficulties. Despite the refinery's demonstrated commitment and strong track record with respect to safe handling of hazardous materials, the surrounding community can be expected to have concerns about any plan to store large volumes of flammable gas containing hydrogen sulfide and other sulfur compounds. Safety concerns are expected to impact site selection as well, with a relatively remote location preferred. Modifications to the recovery, storage and treating of refinery flare gases are subject to the provisions and approval of federal and local regulations including Process Safety Management (PSM), Contra Costa County Industrial Safety Ordinance (ISO), and California Accidental Release Prevention Program (CalARP). Although the objective of the project would be a reduction in flaring, there are expected to be multiple hurdles along the path to a construction/land use permit.

Flare gas treating is used to condition flare gas for use as fuel in the refinery fuel gas system. Treatment is focused on removal of sulfur compounds, with some systems improving fuel value by removing carbon dioxide as well. A range of technology options exist, most of which are based on absorption of acid gases into a "lean" amine solution (MEA, DEA, MDEA, DGA) with regeneration of the resulting "rich" solution by stripping at lower pressure. In order to recover additional fuel gas it is necessary to have sufficient capacity to match the capacity of gas treating systems to the peak flowrate of the flare gas requiring treatment.

In order to assess the potential effect of additional flare gas recovery, a hypothetical design for an upgraded system was developed. The impact that this system would be expected to have on hydrocarbon emissions, based on the refinery's recent flaring history, was then evaluated. Results of this evaluation are provided for three system capacities corresponding to the rate of flow of additional flared gases that could be recovered, the modifications required to achieve that recovery, and the estimated total installed cost for the additional equipment needed for the increase in recovery. The budgetary level (order of magnitude) cost information provided in this section has been developed based on total installed cost data from similar installations where available, otherwise vendor quotes in combination with standard industry cost estimation procedures have been used to estimate system cost.

An evaluation was conducted for the ConocoPhillips, San Francisco Refinery in Rodeo, CA. In order to conduct the analysis a summary of historical flaring was prepared. Flaring events were categorized in order to determine feasible means for reducing flaring through storage, recovery, and treatment. See Attachment H for summary of categorized, historical flaring. The period of 2004 – 2006 was utilized to determine general trends. The data for 2005 was utilized to quantify potential costs and benefits of additional storage, recovery, and/or treatment.

Based on the data review it was determined that four cases should be examined. The cases include the following scenarios:

- Case 1 – Installation of Small Compressor (1.5 MMSCF/day) to enhance existing compressor recovery during peak loading.
- Case 2 – Installation of Large Compressor (6.0 MMSCF/day) to eliminate minor compressor loading events and some flaring events which occur during brief Flare Gas Recovery Compressor (G-503) preventative maintenance periods.
- Case 3 – Installation of high pressure storage sphere, installation of large compressor, and addition of amine treater. Value of this case would be to eliminate all events listed in Case 2 as well as some events which are quality driven (e.g. high Nitrogen & Hydrogen) due to equipment purging.
- Case 4 – Similar to Case 3 with a higher percentage of the volume generated during the quality driven flaring events would be eliminated.

See Attachment I for example schematic of the equipment installations that would be involved in Case 3 and 4.

Listed below is a summary of the overview of the analysis performed and the results of the analysis.

Storage, Treatment, & Recovery Scenario - Emission Reduction & Cost Effective Analysis									
Case	Estimated Potential Reductions (tons/yr)					Cost Effective Basis (tons)	Cost of Control (\$MM)	Annualized Cost of Abatement System (\$MM)	Cost Effectiveness Basis (\$/ton)
	VOC	SO2	Nox	CO	PM				
1	-0.15	-0.62	-0.02	-0.19	<i>negligible</i>	-0.98	\$ 3.25	\$ 1.06	\$ (1,084,092)
2	-1.12	-4.51	-0.13	-1.38	-0.01	-7.16	\$ 7.50	\$ 2.51	\$ (350,420)
3	-1.57	-6.35	-0.19	-1.94	-0.02	-10.07	\$ 23.40	\$ 6.19	\$ (615,476)
4	-2.02	-8.18	-0.24	-2.51	-0.02	-12.97	\$ 23.40	\$ 6.19	\$ (477,509)

¹ Basis is BAAQMD Guidelines for calculation of cost-effectiveness for BACT using the "levelized cash flow method". Costs for equipment were based on cost curves developed by a third-party.

It should be noted that the cost basis did not include the consideration of infrastructure adequacy and did not include all potential equipment and instrumentation necessary. It is expected that once a more rigorous evaluation is performed the costs will significantly be impacted. For example, the cost of infrastructure needs for equipment utilizing electricity and air is expected to be significant. Attachment N contains data utilized to calculate the cost effectiveness of the four cases described above. The storage sphere costs were based on quotes provided by Chicago Bridge and Iron and are contained in the Attachment. A cost curve was prepared by a third-party for the compressor costs. The costs were based on data points of actual costs provided by WSPA membership.

For Case 3 and 4, the evaluation is based on the need for installation of new major systems in order to increase recovery of flare gases from current levels:

- Additional flare gas recovery compressor capacity - the estimated cost to provide additional compressor capacity to recover vent gas flowing in the flare header in excess of current compressor capacity, for transfer to storage and / or treatment. Costs provided are for one unspared compressor system to be added to one existing flare header. The estimate is for a reciprocating compressor with all necessary appurtenances for operation, including knock out pots, coolers, and instrumentation for a fully functional system.
- Addition of surge volume storage capacity – the estimated cost to provide temporary surge storage for a portion of the gases routed to the flare header in excess of the volumes currently being recovered, treated, and consumed. The addition of temporary surge storage volume is necessary for any further increase in flare gas recovery to allow flare gas flow (which is highly variable) to be matched to the demand for fuel gas. The cost used is based on a storage volume equal to the total volume of gas accumulated over one day, and is based on recovery in a high pressure sphere system with discharge at a controlled rate back to the flare gas header. Other lower pressure approaches were considered

(low pressure gas holder, medium pressure sphere), but for the sizes analyzed a high pressure sphere was identified as the preferred approach based on operational, safety and economic considerations.

- Additional recovered gas treatment capacity – the cost of additional amine-based treating capacity to process recovered gases for sulfur removal so that they can be burned by existing fuel gas consumers without exceeding environmental or equipment operational limits. The assumption is that for small increases in treating capacity the existing treater(s) will be modified / upgraded to allow for the increase. No additional cost has been included for expansion of sulfur recovery system capacity.

Based on this review the ConocoPhillips, San Francisco Refinery has concluded that further expansion of systems for the recovery, treatment and use of flared gases is not the most effective approach to reducing these emissions. The refinery has concluded that the major source of flared gases on a volume basis can be attributed to large flow rate, low quality flaring events, especially those of extended duration such as may occur during emergency events or prolonged shutdowns where systems within the refinery are out of fuel gas (and / or hydrogen) balance. Additionally, a synergy was identified that the Refinery will leverage to install additional capacity of 3.3 MMSCFD.

The refinery has allocated significant resources to the development of procedures to plan for, manage, and minimize large flow and duration flaring events. Further resources have also been allocated effectively to ongoing preventive maintenance programs, and even to adjust refinery operations on a severity and throughput basis. These approaches have been identified to be more effective than providing additional flare gas recovery system capacity. Additionally, it is expected that the practices discussed in this plan, specifically the development of a formal turnaround flare management procedure, continuation of incident investigations, and management system programs will result in further reductions of flaring events. These will likely prove to be most cost effective and meaningful.

4.2.2.2 Preventing Production of Low-Quality Flare Gas

Measures to help prevent production of low-quality flare gas, e.g. sour gas, low Btu gas, high nitrogen content are further investigated in this section. The discussion is integrated with the discussion of turnaround and maintenance events as gas quantity (insufficient demand) and gas quality (unscrubbed during upset/malfunction and nitrogen/steam during turnaround) are the primary drivers for flaring during these events. It is for this reason that the measures used to minimize production of low quality fuel gas are closely related to those that can be applied to reduce flaring during maintenance and turnaround events.

Preventing production of sour flare gas is accomplished by making sure that recovered flare gas is routed to the fuel gas system via a gas treating system. It is preventing the production of sour fuel gas that drives the need to match the capacity of treating systems to accept flare gas to flare gas recovery capacity.

High fuel gas nitrogen levels are primarily caused by the nitrogen used to purge hydrocarbons from equipment in preparation for equipment opening. High nitrogen fuel gas content is controlled by limiting the rate at which nitrogen is introduced to equipment and ultimately the flare gas system during nitrogen purging operations. There can be a trade-off between nitrogen flowrate and the effectiveness with which the nitrogen mixes within the contents of the vessel from which hydrocarbons are being removed. These must be balanced on a case-by-case basis to determine the purge rate that represents the best compromise among competing process needs. Scheduling decommissioning activities to minimize overlapping nitrogen purge events is one of the best ways to control the nitrogen content of flare gas.

4.3 Recurrent failure (401.4.3)

- of Pollution Control Equipment
- Process Equipment, or
- A process to operate in a normal or usual manner:

4.3.1 Reportable Flaring Events Attributable to the Same Process or Equipment Item

For the Period from June 30, 2006 to June 30, 2011

A discussion and analysis of each event, including actions taken to avoid future flaring as a result of the same cause and the adequacy of maintenance schedules and protocols. Flaring as the result of malfunctions and upsets is included in the analysis.

Reportable Flaring Events Attributable to the Same Process or Equipment Item		
Date	Process or Equipment Item	Flaring Event Description
There have been no recurrent failures that occurred at the refinery in which the root cause was associated with a refinery equipment failure. There have been third-party supplier outages that have resulted in flaring reportable events. Attachment H contains a listing of the reportable events and the associated corrective actions.		

4.3.2 Means to Prevent Recurrent Failure

There are many programs in place in order to prevent recurrent failures. The programs fall into two major categories; proactive and reactive. The purpose of the proactive programs is to have systems in place based on potential failures that could occur in order to prevent failures from occurring. The reactive programs examine failures that have occurred in order to learn from the failure and develop stronger proactive programs to prevent recurrence. The facility employs many levels of proactive and reactive programs.

4.3.2.1 Proactive Programs

BAAQMD Regulation references “the adequacy of existing maintenance schedules and protocols” for air pollution control and process equipment in respect to recurrent failures. There are major programs in place which support the prevention of failures. Additionally, these programs facilitate continuous improvement to prevent failures. Key programs in place are described below.

ConocoPhillips HSE Management System

ConocoPhillips Corporation requires each refinery to implement a standard Health, Safety, and Environmental (HSE) Management System. This is achieved through providing organization structure, programs, procedures, processes, and resources to manage business activities safely and with respect and care for the environment. The HSE Management System seeks to:

- Demonstrate management commitment to health, safety, & environmental stewardship.

Flare Minimization Plan, BAAQMD 12-12
ConocoPhillips, San Francisco Refinery
BAAQMD Plant 16
October 1, 2011, Rev. 7

- Ensure that all reasonably practicable steps are taken to identify the hazards and risks arising from business activities.
- Establish adequate control over business activities with the aim of achieving safe, incident, and injury free working conditions.
- Maximize the operational integrity, reliability, and efficiency.
- Ensure regulatory compliance.
- Promote high standards and the continuous improvement of HSE performance.

Process Safety Management (PSM)

The refinery must comply with EPA's PSM. Major elements of PSM are also incorporated in California's Accidental Release Prevention Program (CalARP), the Contra Costa County (CCC) Industrial Safety Ordinance (ISO) and EPA's Risk Management Program. There are fourteen elements of PSM, each of these elements is included in some fashion with the programs listed above. In addition, the CCC ISO and CAL ARP program have some additional elements. Although all the elements directly or indirectly prevent failures or minimize the impact of a failure if it occurs, listed below are some of the programs that most directly support failure prevention.

Employee Participation – Employees at all levels must be involved with the elements of PSM. This encourages ownership, participation and buy-in of incident investigation results and means for improvement, and promotes a better safety and operating culture.

Process Safety Information (PSI) – the refinery is required to maintain accurate Process Safety Information. PSI includes chemical inventory, accurate drawings, operating procedures, etc.

Process Hazards Analysis (PHA) - A PHA is a systematic evaluation of the hazards involved in the process. PHAs are required for initiation of a process and at least once every five years after that. The PHA team should be multi-disciplinary, including maintenance, operations, and engineering. The facilitator of the PHA must be trained in the methodology being used. For proper conduct of a PHA, the PSI must be as complete as possible. One of the values of PHA's is to identify potential hazardous and develop means for mitigating hazardous before they occur.

Operating Procedures - Operating procedures include not only the steps for normal operations, but for upset conditions, temporary operations, start-up, and shutdown. Very important safety information must also be included in operating procedures. Contained in the procedures are basic hazards of exceeding operational limits, appropriate response to upset conditions, safety and health information, and emergency operations. The procedures are required to be up to date and reliable. They are also a critical element in training of personnel.

Training - Training is required for all employees new to a process before they become involved in that process. The training must include the hazards of the chemicals and process and what is necessary to protect themselves, their fellow employees, and their surrounding communities. Training should be both written/classroom and hands-on. Employers must evaluate the effectiveness of training and make adjustments to content and frequency of training based on those evaluations.

Pre-Startup Safety Review (PSSR) - The Pre-Startup Safety Review is done before startup of a new operation or startup following a change in the process (see Management of Change, below). It is a means for ensuring that all essential action items and recommendations from the PHA have been completed prior to beginning operations. It is also the point at which the design parameters and standards used for construction are verified. If training or modifications to Process Safety Information (PSI) are necessary, completion of these items is also verified during the PSSR. Startup should not be allowed to occur until all safety-critical PSSR items have been completed.

Mechanical Integrity - Employers are required to have a program to ensure the integrity of processes and equipment. Aspects include listing applicable equipment, training of maintenance personnel, inspection and testing, and maintenance of such systems as controls, vessels, piping, safety systems,

and emergency systems. Development and modifications to the mechanical integrity program should be made based on operational experience, relevant codes, and industry standards.

Management of Change (MOC) - "Change" includes anything that would require a change in Process Safety Information. This includes changes to equipment, processes, and instrumentation. A proper MOC system requires that any change be evaluated prior to its implementation. The level of evaluation can depend on the degree of change and its criticality to the safety of the operation. In addition to the evaluation and approval of a change, MOC requires that suitable training be conducted (if necessary) and the relevant PSI be updated.

Compliance Audits - Per OSHA, compliance audits must be conducted at least once every three years. The purpose of the audits is to determine whether the practices and procedures developed under the provisions of the PSM standard are being followed and are effective. The auditor(s) must be knowledgeable in PSM and should be impartial to the facility being audited. An audit report must be developed and the employer must promptly respond to each of the findings. Once deficiencies are corrected, the corrective action must also be documented.

Maintenance Excellence Philosophy

Predictive Maintenance - The Rodeo Refinery utilizes predictive maintenance tools for both rotating equipment (pumps, blowers, fans, motors) and fixed equipment (pressure vessels, piping, storage tanks). These tools can be used to predict equipment condition and failures so that appropriate preventive measures can be taken, or so repairs can be scheduled prior to a failure. The Rotating Equipment/Reliability Department is responsible for ensuring that rotating equipment is in good condition and the Metallurgical Engineering and Inspection (ME&I) department is responsible for inspecting fixed equipment in the facility.

ROTATING EQUIPMENT

The following is a list of tools and techniques used for maintaining the rotating equipment:

- Operator Inspections/Seal Integrity
- Equipment Deficiencies
- Vibration Analysis
- Lube Oil Testing
- Overhaul Testing

Operator Inspections / Seal Integrity

Operators visually inspect the equipment case and seal/packing area for signs of leakage. Mechanical seals are the number one failure mode in centrifugal pumps. Operations and maintenance personnel include visual monitoring of seals in their shift rounds. In some cases, for example where dual seals are installed, instrumentation (level, pressure, etc.) is available to alert operations that action is required. Seals subject to LDAR (Leak Detection and Repair) regulations are monitored for hydrocarbon emissions on a regular basis.

Operators listen to and observe the equipment operation to detect any unusual noises and/or vibrations that may indicate damage or wear.

Equipment Deficiencies

If a potential deficiency is observed, the operator contacts the Operations Supervisor to request consultation by the appropriate craft or by the Rotating Equipment Group. If it is determined that repair is required, the operator submits a Work Request via the Computerized Maintenance Management System and initiates the steps necessary to make the equipment available for repair. The Work Request documents the deficiencies noted during the operator inspection.

Vibration Analysis

Vibration analysis can be a useful predictive maintenance activity to identify potential equipment failures so that proper maintenance can be scheduled before a failure occurs.

Vibration readings are taken using hand-held piezoelectric accelerometers. Readings are normally taken on all bearing planes (horizontal, vertical, axial). Local panel readings for vibration and temperature, where applicable, are also entered into the data collector. The data is then typically uploaded into the vibration analysis computer, which can be compared to historical data, industry guidelines, or vendor data to assist in scheduling maintenance or indicating the need for additional detailed analysis. Rodeo Refinery personnel participate on a ConocoPhillips Rotating Equipment Best Practices Network to facilitate learning in this area.

Lube Oil Testing

Several pieces of rotating equipment are classified as critical. A sample of lube oil is drawn from the appropriate critical equipment, or other machinery of interest, quarterly or as warranted. This sample is sent to a certified laboratory for a standard set of analyses. The results are transmitted to the Machinery Specialist. The results of each analysis are entered into a computer database as a single record. The data included in the record are:

- Equipment tag number
- Date of sample
- Analysis results

Sample test results are trended and compared to established limits of operation for each specific piece of equipment. If a deficiency is noted, the Machinery Specialist initiates an appropriate corrective action. These could include continued monitoring, oil replacement, filtration, or a repair of the equipment.

Overhaul Inspections

Equipment that has been removed to the shop for repair undergoes a detailed internal inspection to identify wear or damage that could affect performance or mechanical integrity. Machinists perform visual inspections and measure clearances for comparison to manufacturer's specifications. If necessary, the Inspection Group can perform more sophisticated tests (radiographs, ultrasonic, magnetic particle, liquid penetrant and materials analysis) if requested by the Rotating Equipment Group or Maintenance.

FIXED EQUIPMENT

The Rodeo Refinery utilizes the following techniques to ensure fixed equipment is in good condition:

- External Visual Inspection,
- Internal Visual Inspections, and

- Thickness Surveys.

External Visual Inspection

The primary reasons for performing external visual inspections of pressure vessels, piping and storage tanks are to determine the type, rate and causes of any deterioration present that may negatively affect their mechanical integrity and/or service performance and to determine if any maintenance work is required to maintain the equipment in a safe operating condition.

External visual inspections are performed by qualified ConocoPhillips or contract inspectors. The external visual inspection results are documented in an external inspection report. The report is completed and dated by the inspector(s) performing the external visual inspection. It is reviewed by the plant's Inspection Supervisor or authorized representative. The completed report is filed in the equipment inspection history file located in the plant's Inspection Department.

Internal Visual Inspection

The primary reasons for performing an internal visual inspection are:

1. to determine if the essential sections of the vessel are safe to operate until the next inspection;
2. to determine the type, rate and causes of any deterioration present which may negatively affect its mechanical integrity; and,
3. to determine if any maintenance work is required to maintain the pressure vessel in a safe operating condition.

The internal visual inspections are performed by qualified ConocoPhillips or contract inspectors.

Pressure vessels are typically visually inspected internally at least once every 10 years, in accordance with API standards. Non-fired boilers are inspected every 6 years maximum and fired boilers are inspected every 3 years maximum, in accordance with State of California requirements. In practice, many vessels and heaters in sulfur plants are visually inspected internally during a boiler inspection period, at a 3, 6, or 9 year interval and therefore, well within the 10 year maximum interval allowed by API industry standards.

The inspection results are documented in an internal inspection report. The report is completed and dated by the inspector(s) performing the internal visual inspection. It is reviewed by the plant's ConocoPhillips Inspection Supervisor or authorized representative. The completed report is filed in the equipment inspection history file located in the plant's Inspection Department.

Thickness Survey

A representative number of thickness measurements are taken on pressure vessels via ultrasonic and/or radiographic thickness techniques for remaining wall thickness at intervals pre-established by the industry. Thickness surveys are also performed on most process piping runs. The thickness survey is prompted by the plant's Inspection Department to meet all requirements for thickness surveys as outlined in the applicable API standard.

The thickness surveys are performed by qualified ConocoPhillips or contract inspectors who have the appropriate education, experience and qualifications.

The general area of each thickness monitoring location (TML) is ultrasonically scanned and/or radiographed and the lowest reading is recorded. When using ultrasonics, scanning the general area rather than monitoring the same exact location increases the chance of finding local corrosion and typically yields a larger (more conservative) general corrosion rate.

The thickness survey results are completed and dated by the inspector(s) performing the thickness survey. It is reviewed by the ConocoPhillips site Inspection Coordinator or authorized representative. The completed report is filed in the appropriate equipment file and all data is recorded in an electronic database (PCMS System).

Preventive Maintenance - Preventive maintenance activities ensure that equipment and instrumentation function properly through their design life. Examples of these activities are outlined below. Deficiencies are corrected at the time of the inspection where possible or work orders are written to facilitate cleaning or repair.

Instrumentation

Instruments that are critical to unit operations are reviewed and calibrated and cleaned as needed. Examples include flow meters, fire eyes, temperature monitoring devices and analyzers used for performance monitoring and control. Plant performance testing, through pressure surveys, temperature indicators, efficiency calculations or other data collection is used to resolve discrepancies in measurement devices.

Rotating Equipment

To ensure reliable operation of rotating equipment, spare equipment can be operated, where installed, to facilitate repair. Seals and bearings are replaced based on inspections or predictive maintenance activities.

Preventive maintenance tasks include cleaning, adjustment, and lubrication. Operators replace lubricating oil and grease on a frequency set by a master schedule for the Refinery. Appropriate lubricants are specified in a written plan. Steam turbine drivers' over-speed trip protection devices are tested at an established frequency. Fans and mixers are cleaned, lubricated and tested.

Fixed equipment

Thickness measurements and corrosion monitoring (probes, coupons, external UT, and critical process variables) are used to schedule preventive maintenance on vessels. Refurbishment of steel through weld buildup, plate replacement, coatings, or vessel replacement is used to ensure the mechanical integrity of pressure vessels. Refractory is replaced based on inspections, monitoring skin temperatures and thickness in fired equipment and based on internal visual inspections of refractory condition.

Jacketing/Tracing

Integrity of steam and electric tracing used in sulfur processing units is verified through regular plant walkthroughs/checklists by plant operations and maintenance personnel.

Catalyst & Chemicals

Unit catalyst and chemical activity is monitored by unit engineers and operators through pressure surveys and temperature indicators. Lab testing is conducted on intermediate and products to monitor quality. When quality is compromised, operational parameters or other means are employed to ensure continued performance.

Turnaround Inspection And Repair - Major maintenance turnarounds of the process and utility units are planned based on predictive/preventative maintenance activities. Prior to each planned shutdown, a work scope is developed for detailed inspection, repair, replacement and testing of equipment, catalyst and chemicals to ensure the unit will operate properly until the next planned shutdown.

The exact activities for each planned shutdown are determined by Operations, ME&I, Engineering, Reliability and Maintenance personnel prior to each shutdown. A criticality ranking process is used to determine which proposed work activities are included in the turnaround inspections and repairs.

Where practical, maintenance is performed on the equipment while the unit is still in operation. Typical turnaround activities include cleaning equipment, replacing/rejuvenating catalyst and chemicals and inspecting/repairing/replacing equipment as-needed.

Critical Instruments & Safety Instrumented System

The facility has a list of critical devices and has a procedure for handling Safety Instrumented Systems. Safety Instrumented Systems (SIS) take processes to a safe state when predetermined conditions are exceeded. This includes set points such as pressure, temperature, level, etc. These programs maintain the reliability of such devices and systems in order to ensure that shutdown systems have been appropriately established and are reliable.

Near Miss/Good Catch Program

A process is in place that encourages all employees to identify and report potential near misses. Near misses are undesired events which, under different circumstances, could have resulted in harm to people, damage to property or the environment, or production/business loss. Near misses may also include unsafe practices, acts or conditions. The value of this program is that it facilitates:

- Identifying and addressing safety, procedural, environmental impact, design or equipment issues in a proactive, non-threatening manner.
- Identifies learning or training opportunities.
- Sharing of “lessons learned” and best practices with other employees and facilities.

Solomon Refining Comparative Analysis

The refinery participates in periodic comparative analysis. Flare volumes are one of the parameters included. Flare volumes are included in the metric to examine materials that could have been recovered from an economic standpoint. The purpose of the analysis is to determine how facilities compare with their peers in critical parameters.

4.3.2.2 Reactive Programs

When a failure has occurred, depending on the magnitude of a failure, the event will be examined in further detail. Listed below is an overview of the major elements of the programs in place to prevent recurrence of failures.

Incident Investigation

An internal procedure is in place which identifies the type of failures which require incident investigation. This process is a key part of our Health, Safety, and Environmental Management System. Failures captured by this process typically include accidents, injuries, events with potential off-site impact, some levels of flaring events, upsets which result in business loss. The procedure requires that an investigation be conducted and corrective actions identified. The regulatory drivers for this program include, but are not limited to; EPA's PSM, EPA Risk Management Program, Contra Costa County (CCC) Industrial Safety Ordinance (ISO), California's Accidental Release Prevention Program (CalARP). Additionally, there are strong business case drivers for completing incident investigation and preventing recurrence.

Root Cause Reporting

In addition to the incident investigations described above, root cause is required to be reported for higher level events based on various regulatory drivers. Regulatory drivers include but are not limited to; BAAQMD regulations 12-11 & 12-12, EPA SARA/CERCLA reporting requirements, ConocoPhillips EPA Consent Decree requirements, Contra Costa County ISO.

Flare Monitoring & Reporting Procedure

The procedure documents the BAAQMD monitoring and reporting requirements. Additionally, it contains levels in which flare incident investigations must be conducted. The levels correspond to those required by BAAQMD and in the ConocoPhillips Consent Decree. See Attachment E for general overview of the process for reviewing flaring events.

Use of Incident Investigation Documentation Software

ConocoPhillips requires use of a Corporate wide software tool in which certain risk levels of incidents must be tracked. An overview of the incident is included in the software as well as the corrective actions. Depending on the level of the incident, the overview of the incident is immediately shared with Vice President level staff electronically via the software.

High Learning Value Event (HLVE)

If an event occurs in which a lesson learned might have value to sister refineries within ConocoPhillips a system has been established for quickly sharing lessons learned so that other facilities may not experience a similar incident.

Corporate Incident Notification Requirements

Higher level events, such as off-site impacts, require immediate notification to the Corporation.

Flare Minimization Plan, BAAQMD 12-12
ConocoPhillips, San Francisco Refinery
BAAQMD Plant 16
October 1, 2011, Rev. 7

Corporate Health, Safety, and Environmental Reporting Requirements

Flaring volumes are required to be reported and are tracked refinery by refinery to the Corporation on a regular basis.

Key Performance Indicators (KPIs) -

KPIs are reported internally throughout the facility on a weekly and monthly basis. The KPIs include the number and cause of flaring events. The purpose is to inform plant personnel of occurrences of these events and to encourage continuous improvement by tracking cause and number.

Regulatory Notifications

There are various regulatory drivers which require notification of various levels of flaring events. Drivers include; BAAQMD 12-12, EPA's SARA/CERCLA, CCC Community Warning System requirements, etc.

5.0 Other Information Requested by APCO to Assure Compliance (401.5)

5.1 New Equipment Installations (404.2)

A new source review application was submitted to BAAQMD for the installation of new equipment associated with the Clean Fuels Expansion Project (CFEP). The BAAQMD application number is 13424, the permit to construct was issued on March 13, 2007. Both the BAAQMD permit and Environmental Impact Report (EIR) included an evaluation of potential flaring that may occur as part of the project. Minimization techniques utilized for comparable equipment will be utilized for the new equipment/units. No routine flaring is planned or expected to occur with the new equipment/units. Anticipated flaring includes that associated with equipment maintenance, startups, shutdowns, major turnarounds, and during potential emergencies. The types of flaring expected for the new installation comparable to those that have been categorized for existing refinery operations in the section titled "When Flaring is Likely to Occur". Listed below is an overview of the tie-ins and changes to be made to the flare system:

- Installation of three (3) new Liquid Ring Flare Gas Recovery Compressors to increase overall flare gas recovery compressor capacity and provide redundant capacity during maintenance activities.
- Tie-ins from the units listed below for non-routine flaring activities as described above:
 - Unit 246-8 New Heavy Oil Hydrocracker
 - Unit 235 Sulfur Recovery Plant including new Sour Water Stripper and new Amine Regeneration
 - Unit 120 3rd Party Hydrogen Plant – for upstream (i.e. relief valve venting of feed streams)
- Debottlenecking of steam piping to flare to allow for wider smokeless range for both flares. Resulting in an increase from 50,000 lb/hr per flare to 75,000 lbs/hr to each flare with a maximum combined flow of 110,000 lb/hr for both flares..

The major tie-ins, new units, and new compressors are reflected in Attachments C, E, L, and M.

The third-party Hydrogen Plant application was currently processed under BAAQMD Number 13679. The permit application and EIR contemplated flaring that could occur in association with the Hydrogen Plant. The third party plant has a flare on-site. Flaring that could occur at the Rodeo Refinery and is associated with the third party Hydrogen Plant can potentially from feed streams upstream of the new Methane Steam Reformer. Downstream flaring off the Methane Steam Reformer would take place at the third part plant flare.

Flare Minimization Plan, BAAQMD 12-12
ConocoPhillips, San Francisco Refinery
BAAQMD Plant 16

ATTACHMENT A

SAN FRANCISCO REFINERY SIMPLIFIED FLARE SYSTEM OVERVIEW

Attachment A

ConocoPhillips - San Francisco Refinery Simplified Flare System Overview

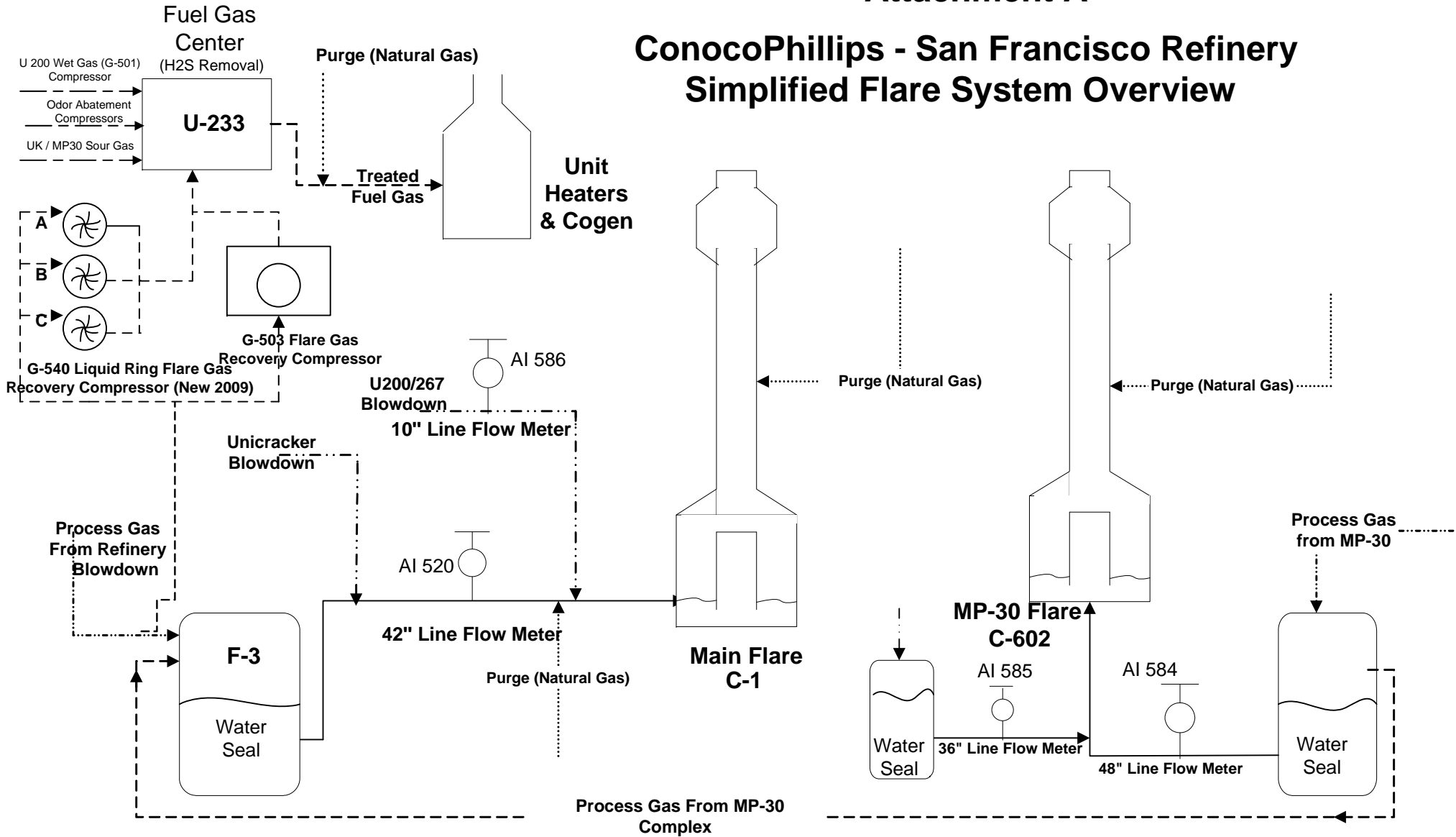

ATTACHMENT B

ConocoPhillips

San Francisco Refinery, Rodeo, CA

Flare Gas System Detailed Description

Listed below is a detailed overview of the facility flare system. Although some parameters are contained in this description they are subject to change as operational or safety enhancements are identified.

The Refinery Relief and Blowdown Systems provide a means for recovery or safe disposal of gases and liquids, which may be generated by the process units. Typical sources of normal flow include coke drum steam-out and switching, sampling, activation of relief valves, distillation tower overhead vapors, and purging of equipment for maintenance or startup. During emergencies, major flow may occur from heater or unit depressuring and the lifting of pressure relief valves. Gases and liquids flow through relief and blowdown lines to blowdown accumulators and knockout drums. Gases and vapors pass overhead to be recovered or flared. The liquids are generally reprocessed through appropriate operating units.

There are two flares in the refinery – the Main Flare and MP-30 Flare. There are three relief and blowdown systems; the Refinery, the Hot Coker Blowdown, and the MP-30 system. Typically the gases sent to the blowdown systems are recovered, treated, and then utilized for fuel in the facility heaters and co-generation equipment. During periods when gases are not recovered, the flare gases are typically sent to the Main Flare. The Refinery and Hot Coker Blowdown system gases are routed to the Main Flare. The units located in the MP30 Complex relieve to the MP-30 Blowdown system. Typically, the gases sent to the MP-30 Blowdown System are recovered in conjunction with the gases from the Refinery and Hot Coker Blowdown system due to interconnecting piping. This interconnecting piping also accommodates minor flaring so that gases from the MP-30 Blowdown System are typically sent to the Main Flare. During major releases from MP-30, the gases would be flared at the MP-30 flare.

There are periods in which the Main Flare is shutdown in association with the Unicracker Complex shutdown. During these periods, the Refinery Blowdown system can be diverted to the MP-30 Flare. The Hot Coker Blowdown system would also be diverted to the MP-30 Flare while the Main Flare is shutdown.

Refinery Relief and Blowdown System

The Main Relief and Blowdown system handles relief and blowdown from the Coking Unit 200, Crude Unit 267, Gasoline Fractionation, Caustic Treating and Deisobutanizer Unit 215, Diesel Hydrotreating Unit 250, Steam Power Plant, Hydrogen Plant Unit 110, Fuel Gas Center Unit 233, the Unicracker Complex including Reforming Unit 244, Unit 246 Heavy Oil Hydrocracker (mid-2009), and Unisar Unit 248, Sulfur Units, Isomerization Unit 228, the Unit 120 3rd Party Hydrogen Plant (mid-2009), and minor MP-30 releases.

During normal conditions, vapor in the flare headers upstream of 19F-3 Water Seal Drum is diverted to the Refinery Flare Compressor G-503 at Unit 200. G-503 compresses this vapor to the refinery gas system at the Fuel Gas Center Unit 233. Flare Gas Recovery Compressors G-540 A/B/C can be used as a total spare for the G-503 compressor. If all of the Flare gas compressors shutdown or the release is too large for the compressor system, the gasses flow through the Refinery Flare Drum 19F-1 and Water Seal 19F-3 - breaking the water seal and are burned in the Refinery Flare.

F-1 Blowdown Drum

Vapor and liquid releases from the units listed above flow through various blowdown headers to Refinery Blowdown Drum F-1. The Unicracker complex has its own separate Blowdown Drum F-45 upstream of F-1 to limit the liquid releases to F-1. Vapor and liquid release from the Unicracker Complex discharge into F-45. Liquids are knocked out and the vapor flows from F-45 through a 36-42" header to F-1. Not all relief valves from the Unicracker Complex discharge to F-45. Relief valves from D-305 Fractionator discharge directly into the 36-42 " header from F-45.

The Steam Power Plant and Unit 110 also have separate Blowdown Drums upstream of F-1 – Blowdown Drum F-35 and Flare Knock Out Drum V-18, respectively. The sites of the Steam Power Plant and Unit 110 have low points in their relief headers. Liquids condensing in the SPP and Unit 110 flare headers to F-1 flow back down the flare header to their respective blowdown drums.

Entrained liquids are knocked out in F-1. At a high liquid level in F-1, blowdown pumps G-1A/1B automatically start and pump the collected liquid through Cooling Water Exchanger E-1 to the foul water tank. The foul water tank has a water phase and hydrocarbon liquid phase. The water phase is fed to the Phenolic Water Stripper D-901. The hydrocarbon liquid phase becomes feed to Coking Unit 200 or to Naphtha Hydrotreater Unit 230.

F-3 Water Seal Drum and Flare Vapor Recovery Compressor Water Seal Drum F-3, located between drum F-1 and the Main Flare, permits the use of the blowdown system and its drums as suction surge for the G-503 Flare Vapor Recovery Compressor during normal releases. F-3 usually contains about an eight foot water seal that diverts the gas in Blowdown Drum F-1 down the main 36" Unicracker blowdown header to the F-509 Knock Out Drum for G-503. The G-503 compressor, located in the Coker Light Ends area, returns the compressed gases to the refinery fuel gas system. The compressor design flowrate is 200,000 scf/hr of 23 MW gas. If more than 4.8 MMSCF/D gas is released to the blowdown system, usually during the steamout of a Coke Drum, one of the G-504 compressors can also take suction on the flare header and can discharge an additional 1.6 MMSCF/D to the refinery make gas system for a total of 6.4 MMSCF/D vapor recovery. When the vapor flowrate is higher than 200,000 scf/hr, vapors released to the refinery blowdown system break through the F-3 water seal and flow to the Main Flare. If the vapors released are from the MP-30 blowdown system, the vapors may also break through the F-604 water seal and flow to the MP-30 Flare. G-503 may also spare the Unit 200 Coker Wet Gas Compressor G-501 or the Unit 200 Odor Abatement Compressors G-60A/B/C. When G-503 is in G-501 or G-60A/B/C service, or G-503 is down, all three G-540 compressors can be placed in flare gas recovery service. Total gas recovery is then limited to 4.8 MMSCF/D. If no flare gas recovery compressors are available, the F-3 water seal is removed, and vapors flow directly to the Main Flare. The F-604 water seal is not removed when G-503 is down, so that flaring of the normal releases only occurs at one flare stack.

Main Flare Header

Flare gas from D-7 Blowdown Drum and Unit 240 reactor depressuring gas release downstream of Water Seal Drum F-3. The Unit 240 reactor depressuring line bypasses drum F-1 and Water Seal Drum F-3 to accommodate depressuring of the reactors at a 300 psi/min rate. The Hot Coker Blowdown bypasses the F-3 Water Seal Drum to minimize back pressure on the Hot Coker Blowdown Drum D-7.

Any gas breaking through the F-3 water seal, vapor from D-7, and/or Unit 240 depressuring gas enter the Main Flare Stack C-1 through a water seal at the base of the flare. This seal is one of the flashback protections for the Main Flare - prevents the backflow of gas or air into the flare lines, which could create explosive mixtures. Additional flashback protections are the molecular seal and continuous purge of the flare stack. An on-line oxygen analyzer is located between F-3 and 19C-1 and sounds an alarm on high oxygen content in the Unit 200 DCS.

Vacuum Protection for Refinery Blowdown System

After a hot vapor release through F-3, the water seal in F-3 will be automatically re-established on level control. To ensure flashback from the flare cannot occur, natural gas is added to F-1 on pressure control (PIC-530) at low pressures. The pressure indicator controller PIC-530 indicates and alarms in the Unit 200 DCS.

Main Flare Purge Gas Requirements

Natural gas supplies purge gas to prevent flashback. The purge gas enters the Main Flare above the water seal at the base of the flare. The molecular seal prevents both convective and diffusional backflow of air into the stack. The proprietary seal design allows some of the rising flare and purge gases to be trapped in the seal. This creates a zone, which is higher than atmospheric pressure and lower in molecular weight than air (lighter than air). Air cannot backflow through such a zone.

Main Flare Pilots

The stack tip has four electronic spark ignited pilots, each with its own ignition system. The pilots utilize electronic spark ignition for an automatic re-light function. When the thermocouple on the pilot senses a pilot outage (low thermocouple reading), the spark igniter immediately reacts to re-light the pilot. After a set period of time, the loss of pilot indication will alarm in the DCS in the Unit 200 control room. Each pilot is equipped with two thermocouples, but only one thermocouple is connected to the DCS for control of the electronic spark system. The other thermocouple is a spare.

As a back-up system to this automatic electronic spark ignition system, each pilot has a manual flame front generator line.

Temperature indicators for each pilot also alarm on low temperature in the Unit 200 DCS to alert the operators that pilot flame-out has possibly occurred. If the low temperature alarm remains on because the automatic spark ignition system has not been successful to re-ignite the pilot, an operator is then dispatched to the field to manually operate the flame front generator to re-ignite the pilot.

Smokeless Flaring at Main Flare

A small continuous flow of steam to the flare is provided to prevent a condensate build-up in the steam line and provide cooling to the flare tip. During a flaring event, additional steam is injected at the tip to aspirate air into the flame and ensure smokeless burning of the flare gases. Flow indicators, located on the two flare headers - 10" header from D-1 and 42" header from F-1-to the Main Flare stack- detect releases to the flare. These flow indicators also alarm in the Unit 200 DCS, so that the Unit 200 operators are aware that gas is being released to the flare. A monitor of the flare is located in the Unit 200 control room; so that the Unit 200 operators can continuously view the flare operation.

MP-30 Relief and Blowdown System

When the Main Flare is in service, normally only the MP-30 Complex major releases flow to the MP-30 Flare. However, the MP-30 Relief and Blowdown System can also handle releases from Coking Unit 200, Crude Unit 267, Gasoline Fractionation, Caustic Treating and Deisobutanizer Unit 215, Diesel Hydrotreating Unit 250, Steam Power Plant, Hydrogen Plant Unit 110, Fuel Gas Center Unit 233, Sulfur Units, and Isomerization Unit 228, when the Main Flare is down for maintenance. During this maintenance period, the blowdown headers for Units 267, 200, 215, 250, 110, 233, 228, Steam Power Plant, and Sulfur Plant Complex headers can be diverted to Blowdown Drum F-2. Releases to F-2 will flow directly to the MP-30 Flare Stack

Diverting the blowdown headers to F-2 is only done, when Blowdown Drum F-1 and/or Water Seal Drum F-3 must also be inspected or repaired with the Main Flare. If F-1 and F-3 do not have to be inspected when Main Flare is down, a 26" interconnecting line downstream of F-3 is opened to the 36" header from F-2. This allows the refinery to keep G-503 Flare Compressor in service during the maintenance of the Main Flare and minimize flaring. Only major releases will break the F-3 water seal and flow through the 26" interconnecting line to the MP-30 Flare.

MP-30 Complex Blowdown Drum F-600

Releases from the Hydrotreating Units 229 and 230 and Reforming Unit 231 flow to Blowdown Drum F-600. Any liquid releases or entrained liquid will drop out in F-600. Liquid in F-600 gravitates to F-603 Drain Pot. On high level in F-603, blowdown pumps G-600/601 automatically start. The liquids are pumped by level control through Blowdown Slops Cooler E-600 to the foul water tank, the same foul water tank for the Refinery Relief and Blowdown System. When level in F-603 has dropped to the preset level, the pumps automatically stop.

Minor vapor releases up to 200,000 scf/hr are diverted from F-600 to the Refinery Blowdown System by a fifteen foot water seal in F-604 Water Seal Drum downstream of F-600. These minor releases flow to the Refinery Blowdown System through a 12" cross-connecting line to the Sulfur Plant/Isomerization Unit common blowdown header. Major vapor releases break the water seal in F-604 and flow through a 42"/48" flare header to the MP-30 Flare.

Vacuum Protection for F-600 and F-604

To prevent a vacuum, PIC-601 on F-600 adds natural gas to the MP-30 Blowdown on low pressure. In addition, the pipe entering the F-604 seal leg rises 19 feet above the top of the 15 foot water seal. Therefore, if a vacuum or partial vacuum occurs in the MP-30 blowdown system, water in F-604 will back flow up the seal pipe, but the seal will not be broken.

On low pressure in the flare header, separate pressure controller PIC-658 adds natural gas to the flare line to prevent flashback. A small continuous flow of natural gas through a restriction orifice sweeps the flare line to ensure the line does not contain any H₂S, NH₃, or other heavier hydrocarbons after flaring ceases.

MP-30 Flare F-2 Blowdown Drum (Partial spare for F-1)

When blowdown headers are lined up to F-2, any entrained liquids in the vapor releases or any liquid releases to F-2 are knocked out in F-2. F-2 is also a low point in the system. Any liquid that condenses in the 36" header will flow back to F-2. At a high level in F-2, blowdown pumps G-2A/B automatically start and pump the collected liquid through Cooling Water Exchanger E-2 to the foul water tank. The foul water tank is the same foul water tank as listed for the Refinery Relief and Blowdown System. When a low level in F-2 is again reached, the blowdown pumps automatically stop.

Even when no Unit blowdown headers are lined up to F-2, F-2 must remain in service when the MP-30 Flare is in service. Any high level at the base of the MP-30 flare is gravity drained to F-2. The continuous purge required for the MP-30 Flare Stack to prevent flashback also flows through F-2.

MP-30 Flare Operation

The MP-30 flare operates similarly to the Main Flare. The MP-30 Flare also has four electronic spark ignited pilots. Pilot operation is basically the same as the Main Flare.

The MP-30 Flare also has a molecular seal. The flare tip is 48" diameter. Natural gas is also used as the purge gas for to prevent flashback. The continuous purge gas requirement of 0.01 ft/sec to the MP-30 Flare Stack is supplied through pressure regulator PCV-565 and flow restriction orifice FO-523 to 19F-2. The purge gas flows from 19F-2 through the 36" flare header to the MP-30 Flare. (The minimum purge requirement of 445 SCF/hr for this flare stack is set by the manufacturer's molecular seal and flare tip design.)

In addition to the molecular seal and continuous purge, a water seal exists at the base of the flare stack to prevent flashback. The seal is designed to have a continuous water purge of 0.5 gpm. A continuous water purge ensures that any condensed hydrocarbon vapor that may accumulate is removed from the base of the flare. The continuous water purge and/or any condensed hydrocarbon gravitate from to F-2 for removal to the foul water tank.

An on-line oxygen analyzer is located on the main 48" flare header downstream of the 36" F-2 flare header and 12" D-7 header connections. The analyzer sounds an alarm on high oxygen content in the Unit 200 DCS to warn operators of potentially explosive mixtures in the MP-30 flare system.

Smokeless Flaring at MP-30 Flare

A small continuous flow of steam is provided to the flare tip to prevent a condensate build-up in the steam line and provide cooling to the flare tip. When flaring occurs, additional steam is injected at the tip to aspirate air into the flame and ensure smokeless burning of the flare gases. Flow indicators, located on the 48" header from MP-30, the 36" header from F-2, and the 12" header from D-7 detect releases to the flare. These flow indicators alarm on high flowrates in the Unit 200 DCS. A monitor of the flare is also located in the Unit 200 control room; so that the Unit 200 boardman can continuously view the MP-30 flare. If there is a flow to the flare or the flare is smoking, the steam to the flare tip is manually increased by the boardman from the Unit 200 DCS.

Hot Coker Blowdown System

The Hot Coker Blowdown system was built with the Unicracker Complex in 1970. Releases to the hot Coker Blowdown System flow through a 16" blowdown header to Blowdown Accumulator F-6. Even though the system is described as the Hot Coker Blowdown system, not all releases are hot nor are all releases from Unit 200 Coking Section. Originally, most of the releases to the blowdown system were from relief valves on heater outlets, blowdown lines from heater outlets, and the relief valves on the Unit 200 Coke Drums (hot releases in excess of 650 °F). However, other factors such as type of material released from a relief valve (i.e. crude) will also cause the relief valve to be connected to the Hot Coker Blowdown System. Other Unit 200 connections include Unit 200 Vacuum Tower relief valve, crude feed pump relief valve, various thermal relief valves for heat exchangers, and pump clean-out/ blowdown lines at Unit 200. The Unit 267 Desalter, crude pump relief valves, and Diesel Filter relief valves discharge to the Hot Coker Blowdown System as well. Although Unit 233 can relieve to either F-6 or F-3 the primary route is through F-6. This is manually controlled. During periods of fuel gas imbalance the excess clean fuel gas is vented to F-6 through the 10" line.

Liquid releases to the Hot Coker Blowdown system drop out in F-6. A high liquid alarm on F-6 that sounds on the DCS alerts the Unit 200 Operators that liquid is flowing to F-6. Operators manually start blowdown drum pump G-61 to pump the liquid to the recoverable oil tank. If the liquid is a hot release, the Operators will divert cooler gas oil from Unit 200 to the Hot Coker Blowdown header to cool the liquid release before pumping to tankage.

Any vapor that is released from F-6 flows to Blowdown Drum D-7. On high temperature in the D-7 overhead line (150 °F), a water deluge control valve automatically opens to flood water into D-7. A high temperature alarm sounds in the Unit 200 control room on the DCS and a valve positioner alarm from this control valve sounds on the Unit 200 alarm panel when the deluge valve opens. This alerts operators that a hot release has occurred and additional operator intervention may be required for D-7. Water gravitates through the water deluge control valve from Tank 286 to D-7 and condenses most of the vapor released to D-7 by contact with the vapor by flowing over the disc and donut baffles inside D-7. Any vapor not condensed will flow overhead from D-7 to one of the flares for combustion. D-7 overhead is normally lined up to the Main Flare.

The water and any entrained hydrocarbon liquid will discharge from D-7 through a water seal leg to the process sewer. During any release at the flares or to the Hot Coker Blowdown System, the pressure in D-7 will not exceed 15 psig. This water seal leg ensures that the water seal is not blown during any potential release.

Some of the condensed hydrocarbon in D-7 will separate from the water at the base of D-7. The operators manually line up D-7 bottom to the Blowdown Drum Pump G-61 to pump the hydrocarbon liquids from D-7 to the recoverable oil tank.

Gasses from the Hot Coker Blowdown system are recovered if the pressure in the blowdown does not exceed the pressure necessary to blow the water seal in the C-1 Flare Stack Water Seal Drum. Gasses are periodically sent to the flare from the Hot Coker Blowdown system. This 10" line is monitored with a separate ultrasonic meter.

Capacity of the Relief and Blowdown Systems

The Refinery and MP-30 flare systems are sized to handle releases during refinery-wide utility failures -refinery-wide power failure, total saltwater cooling system failure, or 150 psig steam failure. The maximum design relief case for both these flare systems is currently a refinery-wide power failure. The design of an individual unit blowdown header may be based on other failures. For example the DIB blowdown header design is based on a refinery-wide salt water failure. The Unit 267 blowdown header design is based on a 150 psig steam failure.

The MP-30 blowdown system (consisting of F-600, F-604, and MP-30 blowdown header) is sized to handle releases from common utility failures for the MP-30 Complex - Units 229, 230, and 231. The two major utility failures, causing the highest relief loads, are power failure and cooling water failure. Power failure creates the highest radiation release concern in the flare area, because a refinery-wide power failure can cause both the MP-30 Flare and the Main Flare to have large releases. An MP-30 cooling water failure creates the highest back pressure in the system for certain MP-30 relief valves.

Interrelated Systems

Wet Gas Stream, process units, and compressor - The light ends section of Unit 200, Crude/Coking Unit, processes the bubble tower wet gas and bubble tower raw naphtha stream to produce a stabilized naphtha. Wet gas (high C3 – C5 content) from the bubble tower reflux drum is compressed by the G-501 Wet Gas Compressor, a multi-stage centrifugal compressor. The compressed gas is mixed with the bubble tower raw naphtha. In exchanger E-511, salt water cools

the combined stream before the stream discharges into the F-502 High-Pressure Separator. Vapor from the high-pressure separator flows to the D-503 Absorber. In D-503, the vapor is contacted with a stripped lean oil which removes the heavier components from the vapor. The scrubbed off-gas from D-503 is then pressure controlled to the light ends sour fuel gas header. The combined sour fuel gas stream from the light ends section flows to Unit 233, the Refinery Fuel Gas Center.

The Flare Gas Recovery Compressor (G-503) can be put into Wet Gas Compressor (G-501) service, if needed. This is done on a planned and emergency basis. The value of this is to minimize overall flaring. The "Wet Gas" Compressor runs at a rate much higher than the Flare Gas Recovery Compressor. The Flare Gas Recovery Compressor typically runs at about 50% of the maximum flow on an annual average basis. When the Flare Gas Recovery Compressor is put into Wet Gas Compressor service the entire capacity of the Flare Gas Recovery Compressor is utilized. Although flaring will likely occur, the total rate of flaring has been minimized by approximately 2.3 MMSCFD by placing the Flare Gas Recovery Compressor into Wet Gas Compressor service.

Odor Abatement: stream, process units, and compressor – There is a group of compressors and a closed vent system referred to as the "Odor Abatement" (OA) system. The OA System is a Refinery wide collection system that includes tank blanketing, vacuum towers non-condensable vapor, de-gassing vapors from various processes, butane tanks vents, and the iso-pentane tank vents. Seasonal ambient temperature increases will impact various processes causing an increase in flow of material to the OA System. The purpose of the system is to collect and control vapors from the sources listed above. Natural gas is purged into the system based on certain set points. Natural Gas as Blanketing Gas for tanks has been used due to low H₂S/Sulfur content, nil oxygen content, consistent quality, and low molecular weight. Low molecular weight and low H₂S/Sulfur are only critical to finished low sulfur products. Nil oxygen content is critical for finished product and intermediate products to prevent formation of materials that foul preheat exchangers.

The compressors help maintain pressure in the system and maintain movement of the vapors. The vapors are routed, via the odor abatement compressors directly to Unit 233 Fuel Gas Center. The vapors are co-mingled with other recovered streams, such as the U200 Wet Gas & Flare Gas Recovery vapors, for sulfur removal.

There are 4 odor abatement compressors. Typically, one or two compressors are operating with a third one as backup. A 4th compressor was installed in 2009. Following the installation of the 4th compressor, 2 to 3 compressors will typically be operated with 1 to 2 spare compressors. The Flare Gas Recovery Compressor can be put into Odor Abatement service, if needed. By utilizing the Flare Gas Recovery Compressor in Odor Abatement service, emissions directly to the atmosphere are mitigated but flaring will likely take place.

F-502- F-502 which is shown on the PFD shown in Attachment B is related to the Wet Gas Compressor system described above. Gasses collected and compressed in the G-501 Wet Gas Compressor are then sent to the Unit 200 F-502 High Pressure Separator. If the Flare Gas Recovery Compressor (G-503) is utilized in Wet Gas Compressor service then the Flare Gas Recovery Compressor would discharge to the F-502 separator.

Flare Minimization Plan, BAAQMD 12-12
ConocoPhillips, San Francisco Refinery
BAAQMD Plant 16

ATTACHMENT C

SAN FRANCISCO REFINERY FLARE SYSTEM PROCESS FLOW DIAGRAM

Flare Minimization Plan, BAAQMD 12-12
ConocoPhillips, San Francisco Refinery
BAAQMD Plant 16

ATTACHMENT D

SAN FRANCISCO REFINERY HISTORICAL STARTUP / SHUTDOWN EVENT DATA (2001 – 2006)

Note: This was a one time review. This review was performed as required by 12-12 during the initial submittal. Following the submittal of the initial FMP Flare RCA's and turnaround flare planning was conducted to address flare minimization for startup / shutdown activities.

ATTACHMENT E

ConocoPhillips

San Francisco Refinery, Rodeo, CA

Unit List

Unit Number	Unit Description
40	Raw Materials Receiving Unit
76	Gasoline Blending Unit
80	Refined Oil Shipping Unit
100	Process Water Unit
110	Hydrogen Plant
120	Hydrogen Plant (new in 2009, 3 rd party operated by Air Liquide)
200	Coking Unit
200	Relief and Blowdown System
215	Gasoline Fractionation and Deisobutanizer, and Caustic Treating Unit
228	Isomerization Unit
229	Mid-Barrel Unionfining Unit
230	Naphtha Unionfining Unit
231	Magnaforming Unit
233	Fuel Gas Center
234	Sulfur Unit
235	Sulfur Unit (new in 2009)
236	Sulfur Unit
238	Sulfur Unit
240	Unicracking Unit
244	Reforming Unit
246	Heavy Oil Hydrocracker (new in 2009)
248	Unisar Unit
250	Diesel Hydrotreating Unit
267	Crude Distillation Unit
MTC	Marine Terminal Complex
SPP	Steam Power Plant
---	Relief and Blowdown System

Flare Minimization Plan, BAAQMD 12-12
ConocoPhillips, San Francisco Refinery
BAAQMD Plant 16

ATTACHMENT F

SAN FRANCISCO REFINERY FLARE MINIMIZATION PROCESS FLOWCHART

Flare Minimization Flowchart

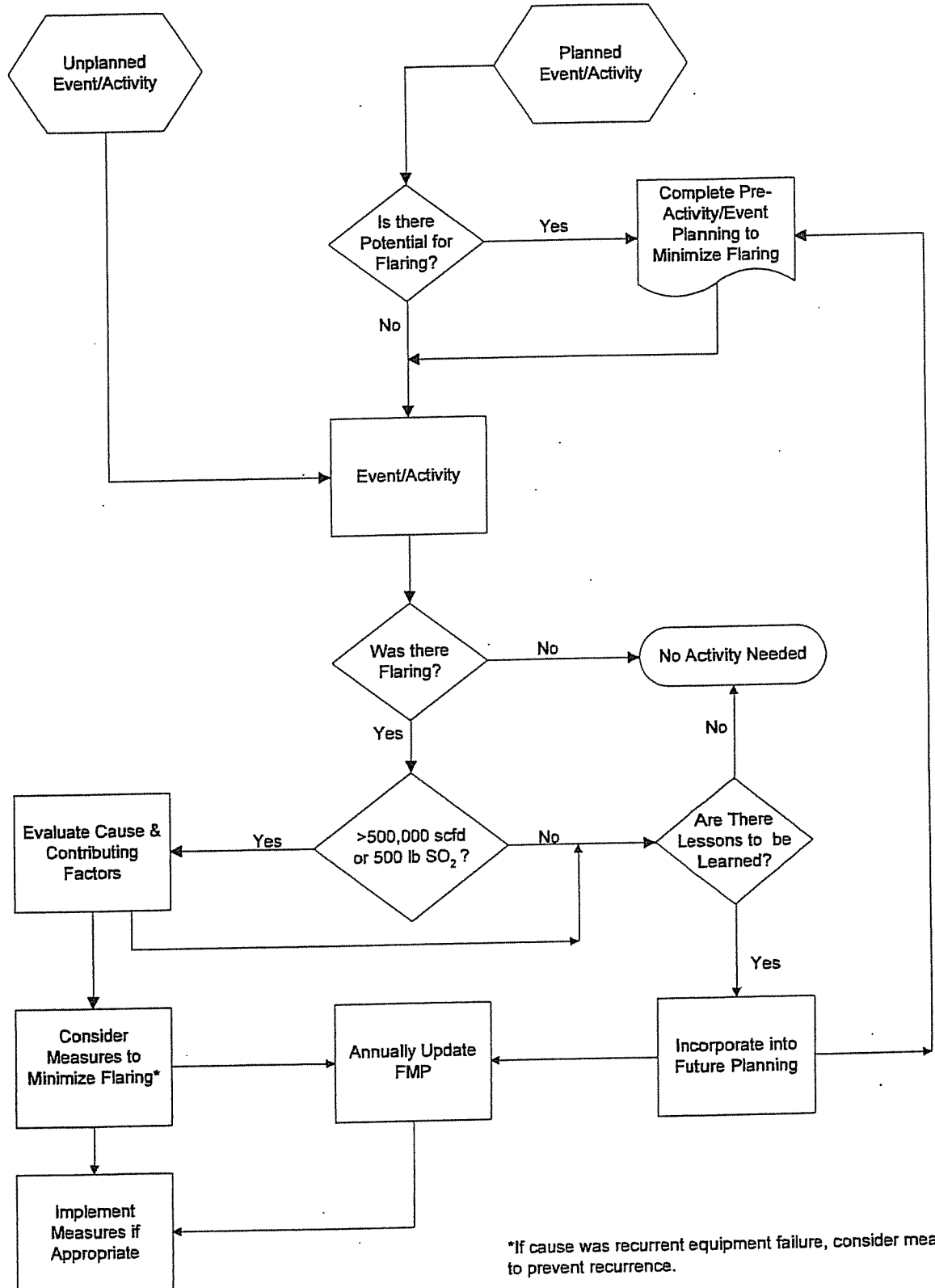

*If cause was recurrent equipment failure, consider means to prevent recurrence.

Flare Minimization Plan, BAAQMD 12-12
ConocoPhillips, San Francisco Refinery
BAAQMD Plant 16

ATTACHMENT G

TYPICAL FLARE GAS RECOVERY SYSTEM

Typical Flare Gas Recovery System

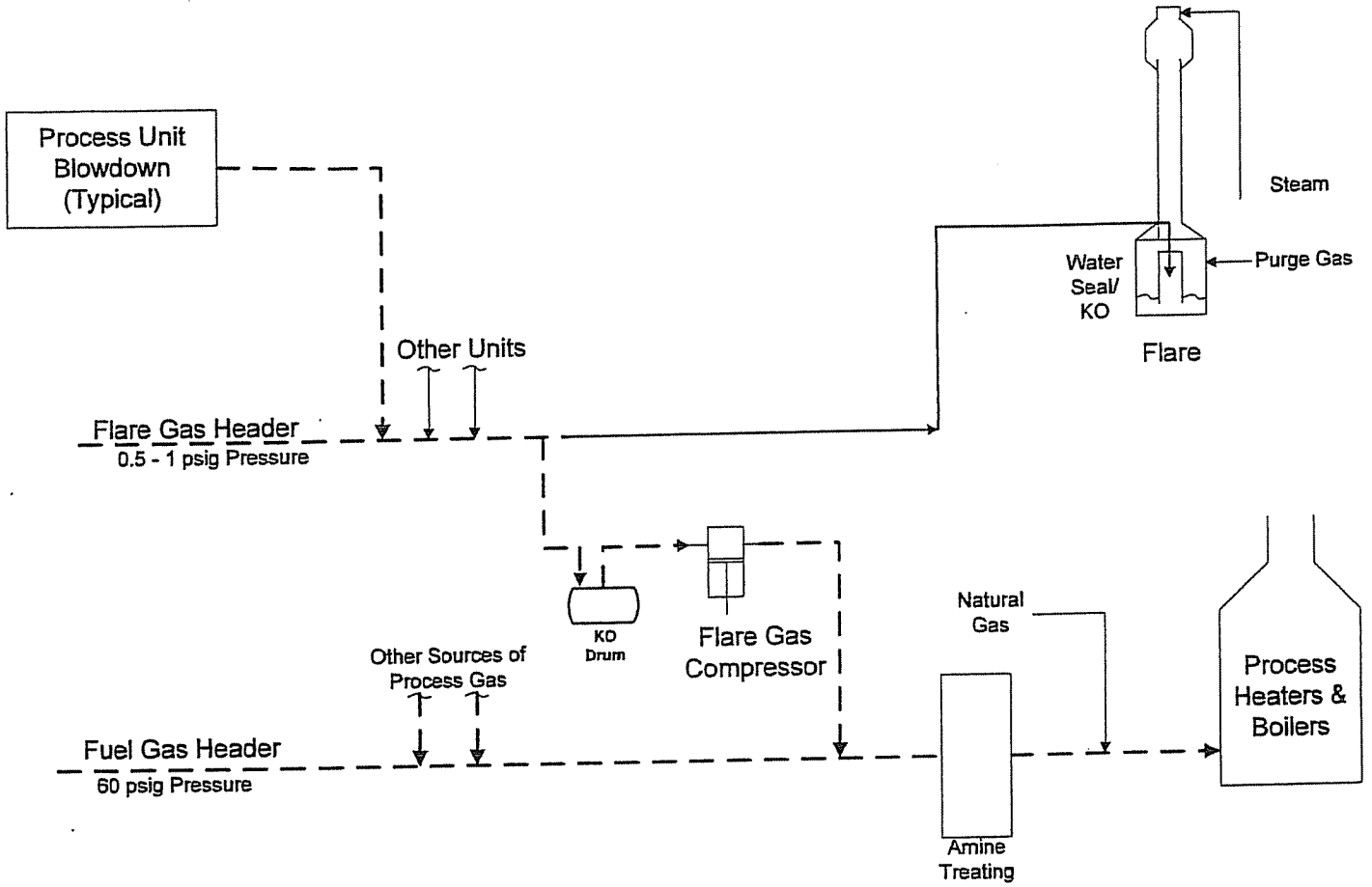

Legend
Normal Flare Gas Recovery Flow Path - - - - ->

Flare Minimization Plan, BAAQMD 12-12
ConocoPhillips, San Francisco Refinery
BAAQMD Plant 16

ATTACHMENT H

SAN FRANCISCO REFINERY FLARING EVENT OVERVIEW & CATEGORIZATION

Historic Flaring Trends - Post Flowmeter Installation

Year	Total Flow (MMSCF/Y)	Events Requiring RCA (MMSCF)	Events Requiring RCA (% of Total Flow)	All Others (MMSCF)	Total (count)	Events Requiring RCA (count)	All Others (count)
2004	234	231	98.51%	3.50	46	5	41
2005	58	55	94.39%	3.28	65	12	53
2006	71	68	95.85%	2.93	67	14	53
2007	43	42	96.93%	1.33	77	6	71
2008	24	21	87.85%	2.95	98	7	91
2009	159	139	87.55%	16.53	109	16	93
2010	37	30	81.70%	6.68	114	13	101
2011 to date	42	38	90.89%	3.80	77	10	67

Small Event Evaluation

Flare Gas Compressor (G 503/G 540) Capacity Exceedance

Year	Count	(MMSCF)	% of Total Flow	% of Non- RCA Flow
2004	34	0.89	0.38%	25.38%
2005	24	0.95	1.62%	28.87%
2006	19	0.27	0.39%	9.29%
2007	32	0.19	0.43%	13.96%
2008	64	1.43	5.87%	48.36%
2009	34	0.45	0.28%	2.71%
2010	24	0.33	0.92%	5.01%
2011 to date	5	0.05	0.11%	1.21%

Fuel Gas Imbalance

Year	Count	(MMSCF)	% of Total Flow	% of Non- RCA Flow
<i>Not individually tracked in past years.</i>				
2009	15	12.38	7.81%	74.89%
2010	34	5.10	13.97%	76.34%
2011 to date	11	0.35	0.83%	9.08%

All flare activity is carefully logged and the cause recorded in the majority of cases. This data is utilized to identify trends as well as tracking which flare events require Root Cause Analysis. This tracking tool helps to provide a means for analyzing the cause of all flaring. For the past few years for small events (<500,000 scfd) the majority of these events fell into two categories; 1) brief fuel gas recovery compressor capacity exceedances, and 2) fuel gas imbalance. Listed below are a discussion of those categories of flaring.

A review of past flaring volumes since the installation of flowmeters was conducted. Based on the review, events which require RCA's per 12-12 constitute on average 95% of the total flow to the flare on an annual basis. A review of the events which don't require RCA was conducted per BAAQMD's request. The category with the most number of similar events is Fuel Gas Recovery Compressor Capacity Exceedances. These typically occur during Coker Drum Cooling but can also be associated with a few other events. Over the year's these type of events comprised 10-50% of the total number of non-RCA events. The addition of the new Liquid Ring Compressors has reduced the occurrence of this category of flaring.

For 2010 and 2011 the highest category of small, non-RCA, events is fuel gas imbalance. This typically occurs when fired sources such as heaters have been shutdown and there is excess fuel gas produced at the units. A tool has been developed to assist in mitigating imbalances when possible and is described in the "Changes Made to Reduce Flare Emissions" under "Fuel System Diagnostic Tools – Developed tools for better fuel flow monitoring & optimization capability". Work is underway with BAAQMD as well to look at permit allowances to help mitigate fuel gas imbalance periods.

Attachment H

Prevention Measures Listed in Causal Analysis Submitted to BAAQMD & Recurrent Failure Analysis

Date	Process or Equipment Item	Flaring Event Description	Root Cause Finding	Action Item(s)	Proposed Dates/Status	Duration, Flow & Emissions	Consistency with Flare Minimization Plan (12-12-406.3)	ESDR No. Recurrent Failure?
6/13/2006	Loss of Salt Water Cooling, G-503 Shutdown	The G-503 Flare Gas Recovery Compressor shutdown due to high gas temperatures from lack of adequate cooling water due to loss of salt water cooling at the refinery.	Hydroblast screen cleaning was not done frequently enough and/or not coordinated with low tide cycles.	<ol style="list-style-type: none"> Develop low tide operating plan. Clean intake structure and screens to remove biological growth. Clean mud and debris from pump bays. Schedule Spring/Fall hydroblast cleanings before low tide cycles. 	<ol style="list-style-type: none"> COMPLETED 7/21/06 COMPLETED 6/13/06 COMPLETED 4/1/2007 COMPLETED 8/06 	Duration: 4 hours Flow: 551 MSCFD Emissions: SO2 – 1,700 lbs (H2S = 1.9%) NMHC – 220 lbs Methane – 90 lbs	n/a – FMP not yet in effect	341-06 N
			Blow back air burst cleaning equipment was not working properly on several intake screens.	Review benefits of higher maintenance frequency for multiple blow valve failures.	COMPLETED 10/1/06			
			Routine operations screen washing is insufficient to manage marine growth on intake screens.	Evaluate alternative options for operations screen cleaning, including anti-foulant coatings.	COMPLETED 10/1/06			
7/10/06	Unit 228 Shutdown	The G-503 Flare Gas Compressor was shutdown when Unit 228 was shutdown. Unit 228 was shutdown due to the GB-520 Hydrogen Compressor shutting down when the electrical circuit tripped, causing the lube/seal oil pumps on the compressor to shutdown.	The coil of fiber optic cable springing loose and moving the breaker on GB-520.	<ol style="list-style-type: none"> Install switch covers. Discuss with contractor the need to secure the fiber optic cable. 	<ol style="list-style-type: none"> COMPLETED 7/11/06 COMPLETED 7/12/2006 	Duration: 7.5 hours Flow: 990 MSCFD Emissions: SO2 – 2,100 lbs (H2S = 1.3%) NMHC – 550 lbs Methane – 315 lbs	n/a – FMP not yet in effect	348-06 N
7/23-24/06	Unit 228 Startup & Shutdown	The G-503 Flare Gas Compressor was shutdown when Unit 228 was shutdown. Unit 228 was shutdown due to the GB-520 Hydrogen Compressor shutting down during a PG&E voltage sag. The protective relay at at GB-520 interpreted the voltage sag as a reverse power situation and triggered the shutdown. In addition, PSV-890 lifted and sent	PG&E voltage sag	Disabled option that shuts down the compressor during a reverse power situation.	COMPLETED 7/23/06	Duration: 17 hours Flow: 1,340 MSCFD Emissions: SO2 – 870 lbs (H2S = 0.38%) NMHC – 700 lbs Methane – 350 lbs	n/a – FMP not yet in effect.	376-06 N
			PSV-890 lifted	PSV-890 was serviced and the back pressure controller tuned.	COMPLETED 7/31/06			
10/26-11/1/06, 11/7/06, 11/17-18/06, & 11/22/06	Unicracker Shutdown, G-503 Shutdown, Fuel Gas	The main cause of flaring was due to the planned shutdown of the Unicracker Complex. During this period there were	Fuel Gas Out of Balance	1. Use of IERC's to allow for temporary higher firing during "fuel gas out of balance period".	1. COMPLETED – approx. Jan 2007.	Duration: 223 hours Flow: 46,145 MSCFD	n/a – FMP not yet in effect.	479-06 N

ESDR No. – Internal document tracking number.

Recurrent Failure – Flaring caused by the recurrent failure of air pollution control equipment, process equipment, or a process to operating in a normal or usual manner. Recurrent is two times or more in a 5 year period. (BAAQMD 12-12-401.4.3)

Attachment H

Date	Process or Equipment Item	Flaring Event Description	Root Cause Finding	Action Item(s)	Proposed Dates/Status	Duration, Flow & Emissions	Consistency with Flare Minimization Plan (12-12-406.3)	ESDR No. Recurrent Failure?
	Out of Balance	numerous units shutting down, reducing system pressure, purging equipment with steam and nitrogen. In addition, there was a Plant 4 unit upset following startup.		Higher firing would result in an increase of the NOx Bubble level. 2. Evaluate permitting options for increasing SPP Turbine SO2 limit during fuel gas out of balance periods in order to minimize or prevent flaring.	2. See Section 3.2 Planned Reductions,	Emissions: SO2 – 8,600 lbs (H2S = 0.3%) NMHC – 7,500 lbs Methane – 8,720 lbs		
			Plant 4 Repairs	Repairs required to be made to complete unit startup & prevent recurrence.	COMPLETED 11/18/06			
12/7/06	G-503 Maintenance	The G-503 compressor was shutdown for planned maintenance. In the course of performing routine equipment checks the Reliability group identified a potential issue via an auditory observation. It was believed the issue was with the loader valve positioner so a shutdown was scheduled.	Loader Valve Failure	1. Repair valve. 2. Upgrade loader valves which are impacted most significantly by gravitational forces.	1. COMPLETED – 12/7/06. 2. COMPLETED - February/March 2007 during G-503 overhaul. See Section 4.3.1 in the FMP for additional details.	Duration: 86 hours Flow: 10,264 MSCFD Emissions: SO2 – 18,339 lbs (H2S = 1.14%) NMHC – 4421 lbs Methane – 3115 lbs	4.2.1.1 Flare Gas Recovery Compressor Maintenance – Minor Maintenance	025-07 N
			Tarry Substance	1. Investigate source of tarry material through analytical testing.	1. COMPLETED Approx. 12/15/06 – no unusual materials discovered. Source indeterminate.			
			Actuator Cylinder Piston Failure	1. Replace failed seal. 2. Conduct regularly scheduled compressor overhaul. Purpose is to perform inspection of equipment and make repairs, as needed.	1. COMPLETED 12/12/06 2. COMPLETED - February/March 2007. See Section 4.3.1 in the FMP for additional details.			
2/24/07	Unit 200 Turnaround & G-503 Shutdown	The primary cause for flaring is due to the planned shutdown of Unit 200 Coker & scheduled overhaul of G-503 Flare Gas Recovery Compressor.	No equipment specific prevention measures identified since these were planned activities. Turnaround pre & post planning was conducted to review expected flaring & minimization techniques to be implemented.	n/a	n/a	Duration: 257 hours Flow: 17,024 MSCFD Emissions: SO2 – 34,220 lbs (H2S = 1.08%) NMHC – 10,800 lbs Methane – 3,000 lbs	FMP 4.2.1 Equipment Preparation for Maintenance (Rev 3, p. 4-17) FMP 4.2.1 Preventative Maintenance – Flare Gas Recovery Compressor Maintenance (Rev 3, p. 4-17)	127-07 N
3/18/2007	Failure in Electrical Power Supply	Power Supply Failure at SRUs	Ground Fault Relay Failure	Replace the faulty relay.	COMPLETED	Duration: 3.75 hours Flow: 1,606 MSCFD Emissions: SO2 – 12,000 lbs (H2S = 4.45%) NMHC – 1,200 lbs Methane – 525 lbs	FMP 4.2.1.4 Equipment Failure which Results in an Immediate or Controlled Unit Shutdown (Rev 3, p. 4-19)	160-07 N
			The Refinery MOC/PHA policy	1. Evaluate and modify as needed the	1. COMPLETED 10/3/2007			

ESDR No. – Internal document tracking number.

Recurrent Failure – Flaring caused by the recurrent failure of air pollution control equipment, process equipment, or a process to operating in a normal or usual manner. Recurrent is two times or more in a 5 year period. (BAAQMD 12-12-401.4.3)

Attachment H

Date	Process or Equipment Item	Flaring Event Description	Root Cause Finding	Action Item(s)	Proposed Dates/Status	Duration, Flow & Emissions	Consistency with Flare Minimization Plan (12-12-406.3)	ESDR No. Recurrent Failure?
			does not encompass electrical design basis reliability	PHA/MOC process to include electrical power distribution adequacy, redundancy, and reliability. 2. Operations & Engineering to conduct joint process reliability reviews of the Sulfur Plant Complex electrical power distribution system.	& on-going. As part of the EUPHA process loss of electrical power is considered. MOCs also consider electrical changes. 2. <i>COMPLETED 9/30/08</i>			
			The Ground Fault Relay did not get tested	Identify and provide a plan to test or replace protective relays that are not normally accessible online or during single unit turnarounds. Review results of all relay testing and respond according to results.	<i>COMPLETED 6/30/08. List of inaccessible protective relays & plan for replacement developed.</i>			
8/20/2007	Pressure Safety Valve (PSV) 7 on Raw Hydrogen Line Opened Prematurely	Unit 110 Hydrogen Plant PRV Lift and Subsequent Flaring	PSV 7 failed and opened prematurely.	Replaced with a new valve.	1. <i>COMPLETED – 8/23/07.</i>	Duration: 73.62 hours Flow: 23,166 MSCFD Emissions: SO ₂ – 21,563 lbs NMHC – 10,110 lbs Methane – 4,840 lbs	FMP 4.2.1.4 Upset/Malfunction – Leaking Relief Valves, PRV Malfunction (Rev. 3, p. 4-20) FMP 4.2.1.4 Other Causes – i.e. Metallurgical Failure (Rev 3, p. 4-21) FMP 4.2.1.4 Maintenance, Turnaround, Startup, Shutdown – Hydrogen Plant Startups (Rev 3, p. 4-17)	353-07 N
			PV 4 Bypass Valve Failed	1. PV 4 bypass was replaced along with a similar type valve in similar service as a precaution. 2. PV 4 bypass was sent out for metallurgical examination.	1. <i>COMPLETED 8/23/2007</i> 2. <i>COMPLETED 9/25/07 (report received) – No further actions based on report findings.</i>			
			Venting of H ₂ to Flare during U110 Startup	As described in the Flare Minimization Plan a review will be completed as to the potential benefit of installing a H ₂ process vent.	Global Prevention Measure - see Prevention Measure section of FMP for current status and plan.			
2/22/2008	Unit 110 Shutdown	Unit 110 was scheduled for a planned turnaround. During the shutdown Hydrogen is sent to the flare blowdown system. The G-503 Flare Gas Recovery Compressor is shutdown when high volumes of Hydrogen are sent to blowdown.	No equipment specific prevention measures identified since these were planned activities. Turnaround pre & post planning was conducted to review expected flaring & minimization techniques to be implemented.	n/a	n/a	Duration: 9.82 hours Flow: 2,908 MSCFD Emissions: SO ₂ – 11,600 lbs (H ₂ S = 2.40%) NMHC – 231 lbs Methane – 1,583 lbs	FMP 4.2 Maintenance, Turnaround, Startup, & Shutdown – Hydrogen Plant Startups (Rev 3)	131-08 N
8-Mar-08	U231 High Liquid Volume	U231 Startup and High Liquid Volume	Shutting down G-503 Flare Gas Recovery Compressor	New Additional Flare Gas Recovery Compressor – as part of the CFEP and Flare Minimization Plan (FMP) commitments a redundant flare gas recovery compressor is being installed. The compressor will be	<i>COMPLETED – August 2009.</i>	Duration: 5.25 hours Flow: 318 MSCFD Emissions:	FMP 4.2 Maintenance, Turnaround, Startup, & Shutdown – Unit Startup (Rev 3, p. 4-17) FMP 4.2 Upset/Malfunction – Loss of Flare Gas Compressor: High Liquid Level (Rev 3, p. 4-20)	227-08 N

ESDR No. – Internal document tracking number.

Recurrent Failure – Flaring caused by the recurrent failure of air pollution control equipment, process equipment, or a process to operating in a normal or usual manner. Recurrent is two times or more in a 5 year period. (BAAQMD 12-12-401.4.3)

Attachment H

Date	Process or Equipment Item	Flaring Event Description	Root Cause Finding	Action Item(s)	Proposed Dates/Status	Duration, Flow & Emissions	Consistency with Flare Minimization Plan (12-12-406.3)	ESDR No. Recurrent Failure?
				able to operate under a wider range of gas composition than the existing the existing G-503 Compressor.		SO ₂ – 1,306 lbs (H ₂ S = 2.5%) NMHC – 324 lbs Methane – 114 lbs		
3/9/2008	Unit 110 Startup	Unit 110 was scheduled for a planned turnaround. During the shutdown Hydrogen is sent to the flare blowdown system. The G-503 Flare Gas Recovery Compressor is shutdown when high volumes of Hydrogen are sent to blowdown.	No equipment specific prevention measures identified since these were planned activities. Turnaround pre & post planning was conducted to review expected flaring & minimization techniques to be implemented.	n/a	n/a	Duration: 4.85 hours Flow: 1,642 MSCFD Emissions: SO ₂ – 1,960 lbs (H ₂ S = 0.72%) NMHC – 1,540 lbs Methane – 600 lbs	FMP 4.2 Maintenance, Turnaround, Startup, Shutdown – Hydrogen Plant Startups (Rev 3, p. 4-17)	151-08 N
20-Mar-08	U250 LIC359 Improperly Ranged	Unplanned Odor Abatement (OA) Compressor Shutdown	Switching G-503 Flare Gas Compressor into Odor Abatement Service	New Additional Flare Gas Recovery Compressor – as part of the CFEP and Flare Minimization Plan (FMP) commitments a redundant flare gas recovery compressor is being installed.	COMPLETED – August 2009.	Duration: 6.83 hours Flow: 850 MSCFD Emissions: SO ₂ – 3,500 lbs (H ₂ S = 2.66%) NMHC – 452 lbs Methane – 345 lbs	FMP 4.2.1.4 Upset/Malfunction – Loss of other compressors (e.g. odor abatement, etc.) (Rev 3, p. 4-20)	225-08 N
			Faulty Level Indication on LIC359 & LIC360	<ol style="list-style-type: none"> 1. Re-range level indications on D-711 vessel so that full scale is seen in the DCS. Obtain proper records of calibration offset. 2. Confirm specific gravity on level indications for D-711 Vessel. Consider re-calibration with water to ensure proper configuration parameters are used. 3. Confirm and document any calibration offset placed in all level displacer indications at Unit 250. Verify correct specific gravity has been used for each level indication. 4. Evaluate a software alarm with logic verifying if both diesel production meters, FIC378 & FIC388 are reading zero. 	<ol style="list-style-type: none"> 1. COMPLETED 3/20/08 2. COMPLETED 3/20/08 3. COMPLETED 3RD Qtr 2009 2. Target 10/1/08 1ST Qtr 2010 			
			Not Identified as a Finding – Prevention Measure	New Odor Abatement Compressor – as part of the Clean Fuels Expansion Project (CFEP) an additional compressor is being added to provide more capacity.	COMPLETED 3 RD Qtr 2009.			
14-Apr-08	G-503 Flare Gas Recovery	G-503 Unplanned Shutdown	Constant Voltage Transformer (CVT) failure on G-503 Flare	Replace CVT	COMPLETED 4/14/2008	Duration: 7.85 hours	FMP 4.2.1.4 Upset/Malfunction – Loss of Flare Gas Compressor (Rev 3, p. 4-20)	283-08

ESDR No. – Internal document tracking number.

Recurrent Failure – Flaring caused by the recurrent failure of air pollution control equipment, process equipment, or a process to operating in a normal or usual manner. Recurrent is two times or more in a 5 year period. (BAAQMD 12-12-401.4.3)

Attachment H

Date	Process or Equipment Item	Flaring Event Description	Root Cause Finding	Action Item(s)	Proposed Dates/Status	Duration, Flow & Emissions	Consistency with Flare Minimization Plan (12-12-406.3)	ESDR No. Recurrent Failure?
	Compressor Constant Voltage Transformer (CVT) Failure		Compressor.			Flow: 618 MSCFD Emissions: SO ₂ – 2,183 lbs (H ₂ S = 2.13%) NMHC – 373 lbs Methane – 258 lbs	FMP 4.2.1.4 Upset/Malfunction – Equipment Failure (Rev 3, p. 4-20)	N
			Unplanned Shutdown of the G-503 Flare Gas Compressor due to equipment failure	New Additional Flare Gas Recovery Compressor – as part of the CFEP and Flare Minimization Plan (FMP) commitments a redundant flare gas recovery compressor is being installed.	COMPLETED – August 2009			
5/16/2008	Unicracker & Unit 200 Planned Shutdown	A planned shutdown was conducted on the Unit 200 Coker/Crude Complex & the Unicracker Complex. During the unit shutdowns there were periods where gas quality and/or quantity could not be recovered by the G-503 Flare Gas Recovery compressor. Thus, the Compressor was shutdown at various times when gas quality and/or quantity issues were occurring.	No equipment specific prevention measures identified since these were planned activities. Turnaround pre & post planning was conducted to review expected flaring & minimization techniques to be implemented.	n/a	n/a	Duration: 45.18 hours Flow: 6,493 MSCFD Emissions: SO ₂ – 24,900 lbs (H ₂ S = 2.16%) NMHC – 2,201 lbs Methane – 2,524 lbs	FMP 4.2.1.1 Equipment Preparation for Maintenance (Rev 3, p. 4-17)	344-08 N
5/28/2008 & 6/2/2008	G-503 Unplanned Shutdown	The G-503 Flare Gas Recovery Compressor (G-503) shutdown unexpectedly due to a high liquid level. A G-503 shutdown occurred again on June 2, 2008 for the same reason. In each case the compressor was re-started as soon as possible once liquids had been removed from the flare gas recovery system. The primary cause was excess butane in the flare gas recovery system.	Removed liquids from flare gas recovery system.	Made process and equipment adjustments to remove liquids from flare gas recovery systems.	COMPLETED 6/2/2008	Duration: 8.75 hours Flow: 719 MSCFD Emissions: SO ₂ – 3,980 lbs (H ₂ S = 3.0%) NMHC – 690 lbs Methane – 218 lbs	FMP 4.2.1.4 Loss of Flare Gas Compressor – High Liquid Level (Rev 3, p. 4-20)	345-08 N
8/19/2008	G-503 Unplanned Shutdown	The G-503 Flare Gas Recovery Compressor (G-503) shutdown unexpectedly due to a high liquid level in the instrument air system. Flaring occurred while the compressor was down.	High liquid level in the instrument air system.	1. Replacement of filters which removes moisture in air system. 2. Updated Operator routine rounds form (R-049) to include draining air system filters every shift.	1. COMPLETED 9/5/08 2. COMPLETED 8/27/08	Duration: 8.88 hours Flow: 1,515 MSCFD Emissions: SO ₂ – 4,700 lbs (H ₂ S = 1.3%) NMHC – 770 lbs Methane – 780 lbs	<ul style="list-style-type: none"> Loss of Flare Gas Compressor – Monitored Safety/Protective Parameter (p. 4-20 Rev. 3) Loss of Flare Gas Compressor – High Liquid Level (p. 4-20 Rev. 3) Loss of Utility – Air (p. 4-20 Rev. 3) 	472-08 N
10/3/2008	G-503 Unplanned Shutdown for Poor Gas Quality (U110 Upset)	The G-503 Flare Gas Recovery Compressor (G-503) was shutdown due to an upset at the U-110 Hydrogen Plant (S-437).	Water in PV-92 Valve Positioner	1. Operators are manually blowing down the instrument air header and checking for water daily. 2. Calibration was checked for both PV-92 and PV-93 and no issues were found.	1. COMPLETED 10/08 2. COMPLETED 10/4/08	Duration: 7 hours Flow: 1,092 MSCFD Emissions: SO ₂ – 1,570 lbs (H ₂ S = 0.86%) NMHC – 340 lbs	Hydrogen Plant PSA operational changes – Switching from 10 bed to 8 and 5 bed operation	516-08 N

ESDR No. – Internal document tracking number.

Recurrent Failure – Flaring caused by the recurrent failure of air pollution control equipment, process equipment, or a process to operating in a normal or usual manner. Recurrent is two times or more in a 5 year period. (BAAQMD 12-12-401.4.3)

Attachment H

Date	Process or Equipment Item	Flaring Event Description	Root Cause Finding	Action Item(s)	Proposed Dates/Status	Duration, Flow & Emissions	Consistency with Flare Minimization Plan (12-12-406.3)	ESDR No. Recurrent Failure?
10/22/08	G-503 Unplanned Shutdown for Poor Gas Quality (U110 Upset)	The G-503 Flare Gas Recovery Compressor (G-503) was shutdown due to an upset at the U-110 Hydrogen Plant (S-437) pressure swing adsorber (PSA). During the upset at U-110, gases sent to the flare gas recovery system could not be recovered by the G-503 compressor.	PV-93 stuck in closed position when the valve over-stroked.	1. Maintenance improved the engineering design and modified the mechanical stops on PV-92 and PV-93 to prevent the valves from over-stroking.	1. COMPLETED 10/24/08	Methane – 440 lbs Duration: 4.33 hours Flow: 2,120 MSCFD Emissions: SO ₂ – 320 lbs (H ₂ S = 0.09%) NMHC – 400 lbs Methane – 650 lbs	Hydrogen Plant PSA operational changes – Shutdown of PSA	523-08 N
11/1/2008	G-503 Unplanned Shutdown	The G-503 Flare Gas Recovery Compressor (G-503) was shutdown due to plugging of the compressor discharge line. During the period when the compressor was shutdown, gases sent to the flare gas recovery system could not be recovered and flaring occurred.	G-503 discharge valve failed to open	1. Steam out of discharge piping scheduled for every 6 – 8 months to prevent material buildup 2. Addition of new Flare Gas Recovery Compressor (item noted after RCA submitted & once it was determined periodic steaming cannot be performed on-line)	1. COMPLETED initially 11/2/08. Later determined this piping can only be steamed out while G-503 is down. 2. COMPLETED August 2009.	Duration: 27.5 hours Flow: 3,744 MSCFD Emissions: SO ₂ – 18,900 lbs (H ₂ S = 3.05%) NMHC – 2,480 lbs Methane – 1,380 lbs	Loss of flare gas compressor – monitored protective parameter triggered shutdown	579-08 N
1/14/2009	G-503 Unplanned Shutdown for Poor Gas Quality (U110 Upset)	The G-503 Flare Gas Recovery Compressor (G-503) was shutdown due to the unscheduled shutdown of the U110 Hydrogen Plant. Excess hydrogen in the flare gas recovery system can damage the G-503 compressor. During the period when the compressor was shutdown, gases sent to the flare gas recovery system could not be recovered and flaring occurred.	Lack of motor bearing lubrication	1. Review and Update the Oil Condition check procedure for limits on oil quantities removed while equipment is in service. 2. Update Reliability Activities Requiring Work Order Procedure for situations where significant oil is to be removed from bearings while equipment is in service. 3. Provide refresher training on these procedures.	1. COMPLETED Aug 2009 2. COMPLETED July 2009 3. COMPLETED Aug 2009	Duration: 9.92 hours Flow: 1,459 MSCFD Emissions: SO ₂ – 4,280 lbs (H ₂ S = 1.77%) NMHC – 150 lbs Methane – 1,020 lbs	<ul style="list-style-type: none"> Maintenance, Turnaround, Startup, Shutdown – Hydrogen Plant Shutdown (Section 4.2.1.1) Upset/Malfunction – Equipment failure which results in a unit shutdown (Section 4.2.1.4) 	089-09 N
1/17/2009	U110 Startup / G-503 Shutdown	The Unit 110 Hydrogen Production Plant was down for a turnaround. During the start up of the Hydrogen Reformer Plant hydrogen is vented to the blowdown system. Unit 200 began recirculating the G-503 Flare Gas Recovery Compressor due to the high volume of hydrogen being sent to the recovery system. This results in flaring of all gases typically recovered through the G-503 compressor as well as the excess raw Hydrogen.	No equipment specific prevention measures identified since these were planned activities. Turnaround planning was conducted to review expected flaring & minimization techniques to be implemented.	n/a	n/a	Duration: 3.6 hours Flow: 1,433 MSCFD Emissions: SO ₂ – 1,550 lbs (H ₂ S = 0.65%) NMHC – 180 lbs Methane – 960 lbs	<ul style="list-style-type: none"> Section 4.2 - Maintenance, Turnaround, Startup, Shutdown – Hydrogen Plant Startups (p. 4-17) 	92-09 N
1/26/09	G-503 Shutdown	The G-503 Flare Gas Recovery	No equipment specific	n/a	n/a	Duration: 7.12 hours	<ul style="list-style-type: none"> Section 4.2.1.4 Maintenance, Turnaround, 	094-09

ESDR No. – Internal document tracking number.

Recurrent Failure – Flaring caused by the recurrent failure of air pollution control equipment, process equipment, or a process to operating in a normal or usual manner. Recurrent is two times or more in a 5 year period. (BAAQMD 12-12-401.4.3)

Attachment H

Date	Process or Equipment Item	Flaring Event Description	Root Cause Finding	Action Item(s)	Proposed Dates/Status	Duration, Flow & Emissions	Consistency with Flare Minimization Plan (12-12-406.3)	ESDR No. Recurrent Failure?
	(low quality gas)	Compressor (G-503) was shutdown due to planned nitrogen purging of drum, D-403C, at the U240 Hydrogen Plant.	prevention measures identified since these were planned activities. Turnaround planning was conducted to review expected flaring & minimization techniques to be implemented.			Flow: 1,441 MSCFD Emissions: SO ₂ – 2,220 lbs (H ₂ S = 0.9%) NMHC – 370 lbs Methane – 830 lbs	Startup, Shutdown – Equipment Preparation for Maintenance (Section 4.2.1.1)	N
March 2 – 9, 2009	Major Unicracker Turnaround	A planned shutdown was conducted at the Unit 240 Unicracker Complex in order to perform scheduled maintenance on several units. During this shutdown, there were periods where flare gas quality and/or quantity could not be recovered by the G-503 Flare Gas Recovery Compressor.	No equipment specific prevention measures identified since these were planned activities. Turnaround planning was conducted to review expected flaring & minimization techniques to be implemented.	n/a – turnaround related	n/a	Duration: 100 hours Flow: 29,488 MSCFD Emissions: SO ₂ – 66,500 lbs (H ₂ S = 1.33%) NMHC – 13,994 lbs Methane – 10,645 lbs	<ul style="list-style-type: none"> Section 4.2.1.1 Maintenance, Turnaround, Startup, Shutdown – Equipment Preparation for Maintenance (Section 4.2.1.1) 	139-09 N
March 14 – 28, 2009	Flare System Maintenance	A planned shutdown was conducted on the Main Flare (S-296) and equipment associated with the flare. The purpose of the shutdown was to conduct preventative maintenance work on the Main Flare and to conduct a required vessel inspection on the F-3 Water Seal drum on the Main Flare system.	No equipment specific prevention measures identified since these were planned activities. Turnaround planning was conducted to review expected flaring & minimization techniques to be implemented.	n/a – turnaround related	n/a	Duration: 298.25 hours Flow: 77,470 MSCFD Emissions: SO ₂ – 218,512 lbs NMHC – 29,092 lbs Methane – 36,183 lbs	<ul style="list-style-type: none"> Maintenance, Turnaround, Startup, Shutdown – Equipment Preparation for Maintenance & Working on Equipment (Section 4.2.1.1) Reduced Consumption of Fuel Gas – Fuel Gas Imbalance (Section 4.2.1.3) 	197-09 N
March 27 – 28, 2009	Odor Abatement Compressor Upset	One of three odor abatement compressors, G-60C, shut down. Unit 200 operators and maintenance personnel attempted to restart the compressor a number of times during the evening shift. The G-60A compressor was already down for planned maintenance. This left only one of the three odor abatement compressors, G-60B, in operation. The facility Standard Operating Procedure (SOP) to switch the G-503 Flare Gas Recovery Compressor from Flare Gas Recovery service to Odor Abatement service was implemented.	Switching G-503 Flare Gas Compressor into Odor Abatement Service	<ol style="list-style-type: none"> A New redundant Flare Gas Recovery compressor is being installed as part of the CFEP and Flare Minimization Plan (FMP) commitments. Addition of a new 4th Odor Abatement Compressor 	<ol style="list-style-type: none"> COMPLETED August 2009 COMPLETED August 2009 	Duration: 43 hours Flow: 6,428 MSCFD Emissions: SO ₂ – 1,359 lbs (H ₂ S = 0.18%) NMHC – 3,135 lbs Methane – 2,629 lbs	<ul style="list-style-type: none"> Upset/Malfunction – Loss of other compressors (e.g. odor abatement, etc.) (Section 4.2.1.1) Reduced Consumption of Fuel Gas – Fuel Gas Imbalance (Section 4.2.1.3) 	196-09 N
			E-11A-2 Leak	<ol style="list-style-type: none"> Replace shell of E-111A-2. Upgrade metallurgy of the E-111A-2 exchanger. Condenser system maintenance such as anode replacement for each exchanger and downcomer piping replacement. 	<ol style="list-style-type: none"> COMPLETED mid-April 2009 COMPLETED mid-April 2009 COMPLETED mid-April 2009. 			
3/29/09	Fuel Gas Imbalance	A planned shutdown was conducted at the Unicracker Complex to perform scheduled maintenance on several units. During this	No equipment specific prevention measures identified since these were planned	n/a – turnaround related	n/a	Duration: 162 hours Flow: 8,836 MSCFD	<ul style="list-style-type: none"> Reduced Consumption of fuel gas – Fuel Gas Imbalance (Section 4.2.1.3) 	198-09 N

ESDR No. – Internal document tracking number.

Recurrent Failure – Flaring caused by the recurrent failure of air pollution control equipment, process equipment, or a process to operating in a normal or usual manner. Recurrent is two times or more in a 5 year period. (BAAQMD 12-12-401.4.3)

Attachment H

Date	Process or Equipment Item	Flaring Event Description	Root Cause Finding	Action Item(s)	Proposed Dates/Status	Duration, Flow & Emissions	Consistency with Flare Minimization Plan (12-12-406.3)	ESDR No. Recurrent Failure?
		turnaround, approximately 30% of the refinery fuel gas consumers were out of service. This resulted in periods of fuel gas imbalance.	activities. Turnaround planning was conducted to review expected flaring & minimization techniques to be implemented.			Emissions: SO ₂ – 147 lbs (H ₂ S = 0.01%) NMHC – 6,791 lbs Methane – 2,375 lbs		
4/19/09	Major Unicracker Turnaround	A planned shutdown was conducted at the Unicracker Complex to perform scheduled maintenance on several units. On April 19, 2009 from 3:50 PM until 9:10 PM there was flaring due to high gas quantity during the Unicracker unit startup. i the turnaround.		Exceeding G-503 Flare Gas Compressor capacity.	1. New redundant Flare Gas Recovery compressor, as part of the CFEP and Flare Minimization Plan (FMP) commitments, a redundant flare gas recovery compressor is being installed. The compressor will provide additional capacity during most periods of operation.	Duration: 5.42 hours Flow: 751 MSCFD Emissions: SO ₂ – 318 lbs (H ₂ S = 0.25%) NMHC – 194 lbs Methane – 411 lbs	<ul style="list-style-type: none"> High base/continuous load (Section 4.2.1.2) Reduced consumption of fuel gas – fuel gas imbalance (Section 4.2.1.3) 	211-09 N
5/6/09	Unplanned Shutdown of Plant 2	The Unicracker Plant 2 experienced an unplanned shutdown due to the auto initiation of a safety system shutdown. The safety shutdown triggered the release of pressure from the reaction section of Plant 2 to the flare.	Catalyst bed collapse	1. Dump, screen, and reload catalyst.	COMPLETED approximately May 20, 2009	Duration: 5 hours Flow: 1,674 MSCFD Emissions: SO ₂ – 30 lbs (H ₂ S = 0.01%) NMHC – 975 lbs Methane – 490 lbs	<ul style="list-style-type: none"> Upset/Malfunction – Equipment Failure which Results in a Controlled Unit Shutdown (Section 4.2.1.4) 	270-09 N
5/10/09	Plant 2 Shutdown	Flaring occurred in association with maintenance being performed at the Unicracker Plant 2. The maintenance scheduled was to address the failure which occurred May 6 th .	Same as 5/6/09 event			Duration: 44 hours Flow: 16,809 MSCFD Emissions: SO ₂ – 453 lbs (H ₂ S = 0.01%) NMHC – 8,658 lbs Methane – 3,386 lbs	<ul style="list-style-type: none"> Equipment Preparation for Maintenance – Depressurization of Equipment & Pressurization of Equipment with Nitrogen (Section 4.2.1.1) Reduced Consumption of Fuel Gas (Section 4.2.1.3) 	278-09 N
5/23/09	Fuel Gas Imbalance	On May 23, 2009 there was a period of fuel gas imbalance in which treated fuel gas was vented to the flare.	No equipment specific prevention measures identified since these were planned activities. Turnaround planning was conducted to review expected flaring & minimization techniques to be implemented.	n/a – turnaround related	n/a	Duration: 6.5 hours Flow: 1,092 MSCFD Emissions: SO ₂ – 20 lbs (H ₂ S = 0.01%) NMHC – 1,000 lbs Methane – 350 lbs	Reduced Consumption of fuel gas – Fuel Gas Imbalance (Section 4.2.1.3)	279-09 N
8/10/09	Fuel Gas Imbalance	On 8/10/09 there was a fuel gas system upset that resulted in high levels of Hydrogen Sulfide (H ₂ S) in the refinery fuel gas. The Federal limit for H ₂ S in fuel gas is 162 ppm (3-hr rolling average). The	Implementation of EOP-15 'High H ₂ S Content in the Refinery Fuel Gas System'. High sulfur fuel gas was temporarily flared and offset	Replace orifice plate on D-803 Amine Regenerator.	COMPLETED 8/11/09	Duration: 4.5 hours Flow: 600 MSCFD Emissions:	Reduced Consumption of Fuel Gas – Fuel Gas Imbalance (Section 4.2.1.3)	359-09 N

ESDR No. – Internal document tracking number.

Recurrent Failure – Flaring caused by the recurrent failure of air pollution control equipment, process equipment, or a process to operating in a normal or usual manner. Recurrent is two times or more in a 5 year period. (BAAQMD 12-12-401.4.3)

Attachment H

Date	Process or Equipment Item	Flaring Event Description	Root Cause Finding	Action Item(s)	Proposed Dates/Status	Duration, Flow & Emissions	Consistency with Flare Minimization Plan (12-12-406.3)	ESDR No. Recurrent Failure?
		recorded levels of H2S during this period ranged from 170-240 ppm (3-hr rolling average), during which time Emergency Operating Procedure EOP-15 was implemented.	with natural gas. Wrong type Orifice plate in the new D-803 Amine Regenerator Steam Supply to the Reboiler.			SO2 – 160 lbs (H2S = 0.16%) NMHC – 290 lbs Methane – 140 lbs		
9/25/09	Unit 246 G-803 Make-Up Compressor Relief Valve Lift	On 9/25/09 at approximately 8:25am, the G-503 Flare Gas Recovery Compressor began to load up & the unit operators noticed that the specific gravity of the gas was very low. In addition, the molecular weight of the flare gas dropped considerably. The G-503 Flare Gas Compressor was taken off-line to protect the compressor.	Unit 246 G-803 Make-Up Compressor Relief Valve lifted due to incorrect valve seat material	Replaced relief valve seating material in valve which relieved and those in similar service.	COMPLETED 9/29/09 (all relief valves)	Duration: 8 hours Flow: 1,020 MSCFD Emissions: SO2 – 1,600 lbs (H2S = 0.97%) NMHC – 230 lbs Methane – 180 lbs	Upset/malfunction - PRV malfunction (Section 4.2.1.4) Upset/malfunction-Fuel Quality Upset (4.2.1.4)	441-09 N
09/29/09	Unplanned Unit 110 Shutdown & Startup	The Unit 110 Hydrogen Production Plant shutdown unexpectedly on 9/28/10. The unit was started up the same day. When the Hydrogen Plant is started up there is a period of time in which the raw Hydrogen is sent to the blowdown system until the Hydrogen meets the necessary purity to be routed to the Hydrogen header. The fuel gas quality is not sufficient for recovery when there is Hydrogen in the blowdown system.	The No. 152 relay on the C-1 Feed Gas Compressor failed. The failure of the relay resulted in a safety shutdown of the unit being triggered.	Replacement of the No. 152 relay.	COMPLETED 9/28/09	Duration: 4.3 hours Flow: 1,520 MSCFD Emissions: SO2 – 2,855 lbs (H2S = 1.13%) NMHC – 194 lbs Methane – 317 lbs	Maintenance, Turnaround, Startup, Shutdown – Hydrogen Plant Startups	414-09 N
10/05/09	Unit 246 Relief Valve Lift	During the early morning of 10/5/09 it was discovered that the relief valve on top of the Unit 246 Cold High Pressure Separator, F-801, was leaking to the MP-30 Flare. The leaking relief valve is PSV-05A/	PSV 05A Lifting.	Remove from service, perform maintenance, seat lapped.	COMPLETED 10/6/09	Duration: 3.3 hours Flow: 300 MSCFD Emissions: SO2 – 115 lbs (H2S = 0.23%) NMHC – 16 lbs Methane – 3 lbs	Leaking relief valves, PRV malfunction – Upset/Malfunction (Section 4.2.1.4)	473-09 N
11/16/09	Unplanned Unit 244 shutdown.	During the morning of 11/16/09 a small flange fire occurred at the Unit 244 Reformer. The unit pressure was dumped to the flare for a unit shutdown, which resulted in flaring.	E-501B Exchanger Leak.	While the unit was down the exchanger flange was tightened & a chemical sealant was applied.	COMPLETED 11/19/09	Duration: 5.5 hours Flow: 830 MSCFD Emissions: SO2 – 615 lbs (H2S = 0.4%) NMHC – 435 lbs Methane – 140 lbs	Equipment failure which results in the unplanned shutdown of a unit – Upset/Malfunction (4.2.1.4)	050-10 N
02/23/10	Unit 110 Hydrogen Plant Scheduled shutdown	On 2/23/10, steps were taken to shutdown Unit 110 Hydrogen Production Plant for a scheduled shutdown. Unit 110 communicated to Unit 200, responsible for the flare, that Hydrogen would be sent to the fuel gas recovery system so that the	n/a - Planned Shutdown	No equipment specific prevention measures identified since these were planned activities.	n/a – planned turnaround	Duration: 4.5 hours Flow: 1,060 MSCFD Emissions:	Maintenance, Turnaround, Startup, Shutdown – Hydrogen Plant Startups.	136-10 N

ESDR No. – Internal document tracking number.

Recurrent Failure – Flaring caused by the recurrent failure of air pollution control equipment, process equipment, or a process to operating in a normal or usual manner. Recurrent is two times or more in a 5 year period. (BAAQMD 12-12-401.4.3)

Attachment H

Date	Process or Equipment Item	Flaring Event Description	Root Cause Finding	Action Item(s)	Proposed Dates/Status	Duration, Flow & Emissions	Consistency with Flare Minimization Plan (12-12-406.3)	ESDR No. Recurrent Failure?
		amt of time the fuel gas recovery compressors were put on circulation would be minimized.				SO2 – 650 lbs (H2S = 0.4%) NMHC – 180 lbs Methane – 470 lbs		
03/11/10	Unit 240 Plant 2 Planned Shutdown with Upset	On 3/11/10 Unit 240 Plant 2 Hydrocracker was starting up after a brief planned shutdown. During the startup, approx 2 hrs after feed had been introduced, the recycle compressor shutdown. This resulted in the unit depressuring to the flare.	2F-201 High Pressure Separator level indicator is calibrated for normal operating feed, not feed used during startup.	Turnaround startup procedure updated to require visual monitoring of sight glass level.	COMPLETED 3/15/10	Duration: 0.3 hours Flow: 485 MSCFD Emissions: SO2 – 1,050 lbs (H2S = 1.3%) NMHC – 170 lbs Methane – 250 lbs	Upset/Malfunction – Loss of a Major Compressor (4.2.1.4)	185-10 N
3/20/10	Unit 110 Startup and U200 High Flow Conditions	On 3/20/10 Unit 110 Hydrogen Plant was scheduled to be started up. Prior to the startup there was high flow to the G-503 and G-540 compressors. The Compressors were shutdown due to high flow and poor gas quality. The Unit 110 startup subsequently occurred which resulted in off-spec hydrogen being sent to blowdown.	The high flow prior to the Unit 110 shutdown was due to a Unit 200 D-203 Drum Wedge Plug Valve which was found to be cracked open.	Reinforce and review Wedge Plug Operation with Drum Switcher qualified operators.	COMPLETED 5/15/10	Duration: 5.5 hours Flow: 1,569 MSCFD Emissions: SO2 – 2,605 lbs (H2S = 1.0%) NMHC – 322 lbs Methane – 845 lbs	High Base/Continuous Load (4.2.1.2) Maintenance, Turnaround, Startup, Shutdown – Hydrogen Plant Startups (4.2.1.1)	198-10 N
4/27/10	Unplanned Shutdown of 3 rd Party Hydrogen Supplier	On 4/27/10 the 3 rd party Hydrogen Plant that provides a significant portion of hydrogen to the refinery experienced an unplanned shutdown. This resulted in intermittent flaring.	As reported by the 3 rd party Hydrogen Supplier, the shutdown was due to a technician performing LDAR monitoring pulling a tag off of a control valve. The tag was attached to the actuator tubing for the control valve and when pulled the tubing came unattached, which resulted in the control valve assuming the fail safe position and shutting down hydrogen production.	The 3 rd party Hydrogen supplier trained their employees and their LDAR contractor on proper locations to hang tags. They also trained them on proper ways for tag removal (cutting, not pulling)	COMPLETED approx. 5/30	Duration: 29.75 hours Flow: 2,656 MSCFD Emissions: SO2 – 1,354 lbs (H2S = 1.59-0.01%) NMHC – 1,455 lbs Methane – 985 lbs	Fuel and Hydrogen Gas Balance (4.2.1.1) – unplanned Hydrogen supplier shutdowns.	223-10 N
6/7/2010	Unit 110 Planned Shutdown	Unit 110 was scheduled for a planned turnaround. During the shutdown Hydrogen is sent to the flare blowdown system. The G-503/540 Flare Gas Recovery Compressors are shutdown when high volumes of Hydrogen are sent to blowdown.	n/a – Planned Shutdown	No equipment specific prevention measures identified since these were planned activities.	n/a	Duration: 6.83 hours Flow: 2,520 MSCFD Emissions: SO2 – 1,140 lbs (H2S = 0.3%) NMHC – 340 lbs Methane – 970 lbs	Maintenance, Turnaround, Startup, Shutdown – Hydrogen Plant Startups & Shutdowns	249-10 N
7/20/10	PG&E Voltage Sag	A voltage sag occurred in the third-party power supply. This resulted in flaring due to the loss of the flare compressors and some other major pieces of equipment. In addition, a number of units had to be	The third-party supplier has been unable to identify the root cause of the voltage sag.	No specific prevention measures were identified by ConocoPhillips because the primary cause was the voltage sag in the electricity supplied by the third-party utility supplier.	n/a	Duration: 21.63 hours Flow: 1,220 MSCFD Emissions:	Upset/Malfunction – Loss of a Utility	349-10 N

ESDR No. – Internal document tracking number.

Recurrent Failure – Flaring caused by the recurrent failure of air pollution control equipment, process equipment, or a process to operating in a normal or usual manner. Recurrent is two times or more in a 5 year period. (BAAQMD 12-12-401.4.3)

Attachment H

Date	Process or Equipment Item	Flaring Event Description	Root Cause Finding	Action Item(s)	Proposed Dates/Status	Duration, Flow & Emissions	Consistency with Flare Minimization Plan (12-12-406.3)	ESDR No. Recurrent Failure?
		shutdown following the voltage sag. This resulted in the flaring of unscrubbed gas.		ConocoPhillips did meet with PG&E about the potential cause of the failure and power dips. PG&E reported they are undertaking a Modular Protection Automation & Control (MPAC) upgrade. This will replace all of the existing 115kV solid state relays with the latest microprocessor based relay standard to provide more line reliability and quick diagnostic tools. During a meeting with PG&E COP Business Manager also requested PGE to perform additional surveillance and increase the frequency of the preventative maintenance programs to the Oleum-Martinez and Oleum-Christy line		SO2 – 3,540 lbs (H2S = 2.27%) NMHC – 880 lbs Methane – 270 lbs		
8/13/10	Unit 110 Startup & F-3 Work	The Unit 110 Hydrogen Production Plant started up after a shutdown period on August 13, 2010. Per the Unit 110 start-up SOP, Unit 200 began re-circulating the Flare Gas Recovery Compressors due to the high volume of hydrogen being sent to the recovery system, which can damage the compressor and decrease the Btu content of recovered gas. Re-circulating the compressors results in flaring of all gases typically recovered through the compressors as well as the excess raw Hydrogen. This resulted in the flaring of unscrubbed gas.	n/a - Planned Shutdown	No equipment specific prevention measures identified since these were planned activities.	n/a – planned turnaround	Duration: 6.32 hours Flow: 2,610 MSCFD Emissions: SO2 – 4,870 lbs (H2S = 1.1%) NMHC – 1,320 lbs Methane – 940 lbs	Maintenance, Turnaround, Startup, Shutdown – Hydrogen Plant Startups.	393-10 N
9/3/10	Unit 110 Startup & F-3 Work	<p>During this flaring event, two separate work activities were coordinated in order to minimize flaring. This resulted in one flaring event of unscrubbed gas instead of two different events had the activities been completed at different times and decreased the amount and duration of flaring that otherwise would have occurred.</p> <p>The Unit 110 Hydrogen Production Plant started up on September 3, 2010 after a brief shutdown period. Prior to the startup of Unit 110, it was determined that maintenance was required on the F-3 Water Seal Drum, which is an integral vessel in the Fuel Gas Recovery System. This work, which involved replacing the F-3 drain piping, was conducted during the Unit 110 startup to minimize flaring at the</p>	n/a - Planned Shutdown	No equipment specific prevention measures identified since these were planned activities.	n/a – planned turnaround	Duration: 5 hours Flow: 1,619 MSCFD Emissions: SO2 – 2,650 lbs (H2S = 1%) NMHC – 750 lbs Methane – 340 lbs	Maintenance, Turnaround, Startup, Shutdown – Hydrogen Plant Startups.	430-10 N

ESDR No. – Internal document tracking number.

Recurrent Failure – Flaring caused by the recurrent failure of air pollution control equipment, process equipment, or a process to operating in a normal or usual manner. Recurrent is two times or more in a 5 year period. (BAAQMD 12-12-401.4.3)

Attachment H

Date	Process or Equipment Item	Flaring Event Description	Root Cause Finding	Action Item(s)	Proposed Dates/Status	Duration, Flow & Emissions	Consistency with Flare Minimization Plan (12-12-406.3)	ESDR No. Recurrent Failure?
		refinery. Had the F-3 work been conducted on its own, it would have resulted in flaring due to the need to shutdown the Fuel Gas Recovery Compressors. The coordination of these two activities minimized flaring from the refinery.						
9/13/10	AL Unplanned Shutdown	The Refinery's third-party Hydrogen Plant, Air Liquide, experienced an unplanned shutdown. As reported by Air Liquide, the cause of the shutdown was due to a faulty thermocouple on an Induced Draft (ID) fan bearing which resulted in loss of hydrogen production from this source. The Refinery had one of its two hydrogen plants in operation at the time. The Refinery's larger hydrogen plant was down for maintenance. The loss of Hydrogen from Air Liquide resulted in multiple refinery upsets. Unit 246, Unit 250 and Unit 240 Plant 2 Second Stage Charge were shutdown. Due to the loss of hydrogen and subsequent shutdown of units and rate reductions, the fuel gas system pressured up, which resulted in flaring. The flaring was of a combination of scrubbed and unscrubbed gas.	<p>Third party unplanned shutdown</p> <p>The third party supplier provided cause and corrective action:</p> <p>The Multilin controller for the ID Fan motor shutdown on a high temperature indication at the bearing. The plant was operating normally at 67% capacity. When the Multilin motor protection relay indicated a high temperature on temperature probe No. 7 (motor bearing) the relay stopped the motor, per design.</p> <p>The root cause was determined to be an installation issue where a larger gauge wire was installed on a smaller gauge terminal block connector. When the ID Fan and motor was replaced in 12/09, the new wire was not equal to the original installation and it was not well secured by the knife blade terminal block connector.</p>	<p>No specific prevention measures were identified by ConocoPhillips because the primary cause was the voltage sag in the electricity supplied by the third-party utility supplier.</p> <p>Third party corrective actions:</p> <ol style="list-style-type: none"> Terminal block incorrect size for installed wiring on C-102 motor. Replace terminal block with one that accepts installed wiring size. Verify wiring terminal block on C-101 motor is correct. Replace terminal block with one that accepts installed wiring size. Wiring may become loose. Epoxy seal new wiring terminal block to prevent terminals from coming loose. Installed instrument cable was not sized correctly for motor RTD terminals. Develop QA inspection procedure for acceptance of newly installed or replaced instrumentation. Personnel with limited access to the Multilin software and training to support plant personnel. Identify sufficient personnel resources and have them trained to access Multilin software. 	<p>See the corrective actions associated with the 10/22/2010 event. After repeated events with the shutdown of the 3rd Party H2 Plant measures were put in place to minimize impact of recurrence.</p> <p>Third party corrective action status.</p> <ol style="list-style-type: none"> COMPLETED 9/13/2010 COMPLETED 9/13/2010 COMPLETED 9/13/2010 COMPLETED 6/13/2011 COMPLETED 12/31/2010 	<p>Duration: 3.22 hours</p> <p>Flow: 600 MSCFD</p> <p>Emissions:</p> <p>SO₂ – 2,340 lbs (H₂S = 2.34%) NMHC – 430 lbs Methane – 180 lbs</p>	Fuel and Hydrogen Gas Balance (4.2.1.1) – included unplanned Hydrogen supplier shutdowns	436-10 N (3 rd party)
9/25/10	Unit 240 G-425 Level Indicator Failure	On September 25, 2010 at approximately 3:14 P.M. an increase in fuel gas system pressure led to flaring of treated fuel gas. At approximately 4:30 P.M. the G-503 Fuel Gas Recovery Compressor was circulated	Unit 240 Plant 4 LIC 429 Level Controller Malfunction	1, Operate the F-429 Knock Out Drum in manual (i.e. take 4 LIC 429 out of service) COMPLETED 9/25/10		<p>Duration: 4.32 hours</p> <p>Flow: 354 MSCFD</p> <p>Emissions:</p>	<p>et/Malfunction – Failure of Instrumentation</p> <p>et/Malfunction – Loss of Fuel Gas Recovery Compressor / High Liquid Level</p>	431-10 N

ESDR No. – Internal document tracking number.

Recurrent Failure – Flaring caused by the recurrent failure of air pollution control equipment, process equipment, or a process to operating in a normal or usual manner. Recurrent is two times or more in a 5 year period. (BAAQMD 12-12-401.4.3)

Attachment H

Date	Process or Equipment Item	Flaring Event Description	Root Cause Finding	Action Item(s)	Proposed Dates/Status	Duration, Flow & Emissions	Consistency with Flare Minimization Plan (12-12-406.3)	ESDR No. Recurrent Failure?
		due to high liquid level. Although the G-540 Compressors were in operation, the circulation of the G-503 Compressor resulted in flaring of unscrubbed gas.				SO ₂ – 791 lbs (H ₂ S = 1.35%) NMHC – 200 lbs Methane – 100 lbs		
10/6/10	3 rd Party Hydrogen Plant Unexpected Shutdown	<p>At approximately 4:40 PM the Refinery's third-party Hydrogen Plant, Air Liquide, experienced a sudden shutdown. As reported by Air Liquide, the cause of the shutdown was due to a valve issue on their Pressure Swing Adsorber (PSA). When the PSA valve stuck it led to a shutdown of their Reformer Heater due to high firebox pressure. The Refinery had one of its two hydrogen plants in operation at the time. The Refinery's larger hydrogen plant was down for maintenance. The loss of Hydrogen from Air Liquide resulted in multiple refinery upsets. Feed was removed from Unit 246, Unit 250 and Unit 240 Plant 2 Second Stage Charge. Due to the loss of hydrogen and subsequent shutdown of units and rate reductions, the fuel gas system pressured up, which resulted in flaring of scrubbed and unscrubbed gas.</p> <p>Following the Air Liquide Hydrogen Plant shutdown, approximately 20 MMSCFD of fuel and feed gas that is normally supplied by the refinery to Air Liquide was diverted to the refinery fuel gas system. This excess gas caused the refinery fuel gas system to pressure up which resulted in approximately 674 MSCF of sweet fuel gas being sent to the flare from October 6 to 8, 2010. During the upset a relief valve (PSV 069) at Unit 240 Plant 2 relieved prematurely. Its setpoint is 290 psig, it relieved at approximately 250 psig. This resulted in additional flow, primarily Hydrogen, to the flare from 6:00 PM until 8:00 PM on October 6, 2010. Prior to the Air Liquide shutdown the G-503 Fuel Gas Recovery Compressor was down for maintenance. The G-540 Fuel Gas Recovery spare compressors were in service. During the upset the G-540 Fuel Gas Recovery compressors remained operational.</p>	<p>The primary root cause was due to the sudden shutdown of the third-party Hydrogen Plant. As described above, ConocoPhillips did implement measures to minimize flaring during the upset. Listed below is a prevention measure completed in respect the the relief valve which lifted following the upset.</p> <p>The third party H2 Plant supplier did provide root cause and corrective actions.</p> <p>The Steam Methane Reformer tripped on high box pressure when the PSA went from 12-bed to 10-bed operation. The root cause of the trip was inadequate PV-1611 response. The response resulted in a feedback mismatch of greater than 20% that exceeded 7 seconds. This feedback mismatch caused the PSA to go from 12 to 10-bed. The consequential disturbance in off-gas flow as the PSA adjusted to the new operating mode then caused an upset in the furnace pressure control ultimately leading to a plant trip.</p>	<p>Inspect and repair PSV069.</p> <p>See the corrective actions associated with the 10/22/2010 event. After repeated events with the shutdown of the 3rd Party H2 Plant shutdown, measures were put in place to minimize impact of recurrence.</p> <p>The third party supplier provided the following prevention measures.</p> <ol style="list-style-type: none"> 1. Operators have to reduce PC-412A (off gas flare relief) from 6 psi to 4 psi to account for high off gas pressure. Investigate feasibility and implement a DCS response based on PSA signal of bed switch over event. 2. C-102 damper actuator responds slowly. <ol style="list-style-type: none"> a. Tune PC-402 damper system. b. C-102 damper inspection/discovery is scheduled. 3. Initiating event for PSA beds tripping off, not logged. Ensure alarm logger is running while plant is up. 4. No means of monitoring valve on-line performance. Investigate feasibility of AMS. 5. PSA UOP specifications do not match valve specifications. Investigate changing valve specifications to match UOP and monitoring valve local alarms. 6. Possible contamination. Inspection of IA header scheduled for turnaround. 7. PSA has not been tuned at higher rates. Tune PSA bed at higher rates. 	<p>COMPLETED, approximately during the week of 10/6/2010</p> <p>Status of corrective actions provided by Third party</p> <ol style="list-style-type: none"> 1. COMPLETED 6/15/2011 2. <ol style="list-style-type: none"> a. COMPLETED 6/15/2011 b. COMPLETED 6/15/2011 3. COMPLETED 10/8/10 4. COMPLETED 12/31/10 5. COMPLETED 6/15/2011 6. COMPLETED 6/15/2010 7. COMPLETED 11/15/2010 	<p>Duration: 31.5 hours</p> <p>Flow: 1,815 MSCFD</p> <p>Emissions:</p> <p>SO₂ – 4,650 lbs (H₂S = 1.56%) NMHC – 1,110 lbs Methane – 535 lbs</p>	<p>Fuel and Hydrogen Gas Balance – including unplanned Hydrogen supplier shutdowns</p>	<p>473-10</p> <p>N (3rd party)</p>

ESDR No. – Internal document tracking number.

Recurrent Failure – Flaring caused by the recurrent failure of air pollution control equipment, process equipment, or a process to operating in a normal or usual manner. Recurrent is two times or more in a 5 year period. (BAAQMD 12-12-401.4.3)

Attachment H

Date	Process or Equipment Item	Flaring Event Description	Root Cause Finding	Action Item(s)	Proposed Dates/Status	Duration, Flow & Emissions	Consistency with Flare Minimization Plan (12-12-406.3)	ESDR No. Recurrent Failure?
10/22/10	3 rd Party Hydrogen Plant Unexpected Shutdown, Cogen and Refinery Shutdown	The Refinery's third-party Hydrogen Plant, Air Liquide, that provides a significant portion of hydrogen to the refinery, experienced a sudden shutdown. The shutdown of the Hydrogen Plant led to the shutdown of several process units and the refinery Steam Power Plant (SPP). Without steam, the majority of the refinery units were required to shutdown. These shutdowns resulted in flaring of scrubbed and unscrubbed gas on October 22, 2010 which then continued intermittently until October 23, 2010.	Air Liquide Shutdown	<ol style="list-style-type: none"> COP intends to operate Plant 4 Hydrogen Plant until Air Liquide completes actions to improve reliability. COP has teamed with Air Liquide in an engineering study to improve reliability. 	<ol style="list-style-type: none"> COMPLETED. COMPLETED during 2011 2nd Qtr 2011 t/a. 	Duration: 29 hours Flow: 12,657 MSCFD Emissions: SO ₂ – 17,422 lbs (H ₂ S = 0.66%) NMHC – 4,330 Methane – 2,745	Fuel and Hydrogen Gas Balance including unplanned Hydrogen supplier shutdowns Upset/Malfunction Loss of Utility (steam, air, cooling water, power)	475-10 N (3 rd party)
			Fuel Gas System Pressure Increased	<ol style="list-style-type: none"> Identify and implement solutions for fuel gas system pressure increase when AL shutdown. Revise the Refinery Emergency Operating Procedure (EOP-21) to better address AL shutdowns. 	<ol style="list-style-type: none"> COMPLETED – PRV added during June 2011 t/a to divert fuel gas to flare during upset. COMPLETED 3/1/2011 			
			Condensate blowin into GT23C by air purge	<ol style="list-style-type: none"> Revised the SPP Turbine emergency shutdown procedure to block in the steam injection for all operating turbines if the steam injection is lost for any reason. Evaluate changing the air purge drop out to include a manual reset before it can be activated after a drop-out event. 	<ol style="list-style-type: none"> COMPLETED. COMPLETED 11/1/2010. An alternative to the manual reset was identified to be an improved mitigation. EOP-501-SPP was updated to reflect a procedural change step. 			
			Loss of SPP instrument air	<ol style="list-style-type: none"> Revise the SPP Turbine emergency shutdown procedure to block in the instrument air to a shutdown turbine to prevent loss of instrument air. Repair the PCV-905 pressure regulator to ensure that it will fully open when the SPP instrument air drops below 80 psig. Inspect the SPP instrument air system for leaks at next t/a. 	<ol style="list-style-type: none"> COMPLETED COMPLETED COMPLETED during 2011 t/a's. 			
10/27/10	Unit 240 DIB Overhead Hydrate Line Plug	On October 27, 2010 at approximately 1:30 A.M. flaring of unscrubbed gas commenced at a relatively low volume. At that time ConocoPhillips also discovered a hydrate plug in the Unit 240 Plant 3 D-301 overhead system. The rate of flaring increased over time. At 5:18 AM the G-503 Fuel Gas Recovery Compressor was	D-301 Overhead Temperature dropped below 65 F during startup.	Update Unit 240 Plant 2/3 startup procedures to specify that overhead temperature should not be below when 65 F when feed from Plant 2 is introduced. TOP-PL2-202-Section 1 Startup TOP-PLT2-202-Section 2 Startup	COMPLETED	Duration: 7 hours Flow: 2,997 MSCFD Emissions: SO ₂ – 11,420 lbs (H ₂ S = 2.29%)	Upset/Malfunction – Equipment Plugging	472-10 N

ESDR No. – Internal document tracking number.

Recurrent Failure – Flaring caused by the recurrent failure of air pollution control equipment, process equipment, or a process to operating in a normal or usual manner. Recurrent is two times or more in a 5 year period. (BAAQMD 12-12-401.4.3)

Attachment H

Date	Process or Equipment Item	Flaring Event Description	Root Cause Finding	Action Item(s)	Proposed Dates/Status	Duration, Flow & Emissions	Consistency with Flare Minimization Plan (12-12-406.3)	ESDR No. Recurrent Failure?
		shutdown which resulted in additional flaring. ConocoPhillips cleared the hydrate plug around 6:10 AM. The G-540 and G-503 Fuel Gas Recovery Compressors were put in service at 7:10 AM and 7:45 AM respectively, once ConocoPhillips determined the plugging issue had been resolved.				NMHC – 1,650 lbs Methane – 860 lbs		
1/22-27/2011	Fuel Gas Balance	Turnarounds were taking place at units that included large combustion sources during January 2011. Due to the number of process units in turnaround, there were periods where all of the fuel gas produced could not be consumed. Due to the imbalance in the fuel gas system, the additional fuel gas that could not be consumed by the refinery process heaters was flared. Periods of fuel gas imbalance where the flow exceeded the BAAQMD reporting threshold of 500,000 standard cubic feet per day (scfd) occurred from January 22 until January 27, 2011. During this period, only excess treated (scrubbed) fuel gas was flared. In addition, a large volume of nitrogen was used to depressure and purge one of the units as part of its shutdown. This nitrogen was sent directly to the flare.	No specific prevention measures were implemented but measures were taken to minimize the quantity of material flared.	n/a	n/a	Duration: 128.42 hours Flow: 16,802 MSCF SO ₂ – 415 lbs (H ₂ S = 0.01%) NMHC – 9,620 lbs Methane – 3,186 lbs	Reduced Consumption of Fuel Gas – Fuel Gas Imbalance (Section 4.2.1.3)	137-11 N
2/15/2011	Unit 110 Startup	The Unit 110 Hydrogen Production Plant started up on February 15, 2011 after a planned shutdown. Per the Unit 110 start-up SOP, Unit 200 began re-circulating the G-503 Flare Gas Recovery Compressor due to the high volume of hydrogen being sent to the recovery system, which can damage this compressor. During this period each of the G-540 Flare Gas Compressors were put in service. They can handle more varied gas quality and the fuel gas was not negatively impacted by the excess hydrogen being added. The flaring of unscrubbed gas and hydrogen occurred during this flare event.	No new prevention measures or corrective actions were identified. The Unit 110 startup is a planned activity that will re-occur in the future. Due to the unplanned shutdown with the third-party H ₂ Plants as detailed in the 10/22/10 event the Plant 4 H ₂ plant was kept in operation for reliability purposes. This resulted in additional Unit 110 Startups and Shutdowns when the plant is long on Hydrogen production in association with other unit shutdowns.	n/a	n/a	Duration: 2.16 hours Flow: 641 MSCFD Emissions: SO ₂ – 700 lbs (H ₂ S = 0.67%) NMHC – 127 lbs Methane – 128 lbs	Maintenance, Turnaround, Startup, Shutdown – Hydrogen Plant Startups	138-11 N
2/21/2011	Unit 240 DGA Upset, Fuel Gas balance & Plant 4 Shutdown	An electrical outage at the Diethylene Glycol Amine (DGA) pumps, located at Powerhouse No. 3 in the Unicracker Complex, resulted in higher than normal concentrations of H ₂ S in the fuel gas system. This resulted in a fuel gas upset	High resistance due to connection issue.	1. Properly clean and inspect Bus connections during maintenance periods. 2. Consider performing ultrasonic testing	1. Ongoing with unit turnarounds. 2. Ongoing with unit turnarounds.	Duration: 37.5 hours Flow: 7,652 MSCF Emissions:	Upset / Malfunction – Loss of a Utility	192-11 n

ESDR No. – Internal document tracking number.

Recurrent Failure – Flaring caused by the recurrent failure of air pollution control equipment, process equipment, or a process to operating in a normal or usual manner. Recurrent is two times or more in a 5 year period. (BAAQMD 12-12-401.4.3)

Attachment H

Date	Process or Equipment Item	Flaring Event Description	Root Cause Finding	Action Item(s)	Proposed Dates/Status	Duration, Flow & Emissions	Consistency with Flare Minimization Plan (12-12-406.3)	ESDR No. Recurrent Failure?
		<p>which started in the Refinery Fuel Gas A (RFG A) and later migrated to the Unit 233 fuel gas system. RFG A that normally would be fed to the third party Hydrogen Plant was dropped out to prevent unit damage. Since RFG A is used as feed and fuel this upset resulted in a sudden fuel gas imbalance. The G-503 and G-540 Flare Gas Recovery Compressors were circulated as part of implementing Emergency Operating Procedure (EOP) 12 "Total Loss of DGA Circulation". Following the upset there was a period of fuel gas imbalance the following day since the large Unit 240 B401 Hydrogen Plant remained shutdown. This flare event resulted in the flaring of unscrubbed and scrubbed gas.</p>		<p>preventative maintenance of powerhouses and substations.</p>		<p>SO2 – 8,614 lbs (H2S = 1.38%) NMHC – 5,559 lbs Methane – 1,988 lbs</p>		
			<p>Equipment Problems related to this upset.</p>	<ol style="list-style-type: none"> 1. Replace aluminum Bus Bars with copper Bus Bars. 2. Consider relocating 4GM-415A starter to the Plant 31 MCC. 	<ol style="list-style-type: none"> 1. Target 7/1/2012 2. Target 7/1/2012 			
4/4/2011	Voltage Sag resulting in Fuel Gas Overpressure	<p>On April 20, 2010 a voltage sag occurred in the third-part power supply. This resulted in flaring of unscrubbed gas due to the loss of two fuel gas compressors and some major pieces of equipment. A number of units were temporarily impacted by the voltage sag.</p>	<p>No specific prevention measures were identified by ConocoPhillips because the primary cause was the voltage sag in the electricity supplied by the third party supplier.</p> <p>The third party electricity supplier did report that they found a flashed insulator approximately 3 miles from the Christie substation nearest to Oleum – North Tower – Martinez Junction. Although they did not know the exact cause of the flash the third party scheduled it for replacement during the following month.</p>	n/a	n/a	<p>Duration: 15.75 hours</p> <p>Flow: 820 MSCF</p> <p>Emissions:</p> <p>SO2 – 163 lbs (H2S = 0.15%) NMHC – 607 lbs Methane – 195 lbs</p>	Upset/Malfunction (4.2.1.4) – Loss of a Utility	338-11 N (3 rd party)
5/13 – 14/11	Unit 200 Steaming for Shutdown and G-540 Fuel Gas Compressor Shutdown	<p>The Unit 200 Coker/Crude unit was beginning a major turnaround. Steaming was being conducted at the unit to allow for entry and maintenance work to begin. Due to the high temperatures which occur during steaming the G-540 Flare Gas Recovery Compressors could not remain in operation. The G-503 Flare Gas Recovery Compressor had been shutdown prior to the turnaround for control system upgrades. Flaring of unscrubbed gas</p>	<p>No new prevention measures or corrective actions were identified. The Unit 200 turnaround and associated steaming is a planned activity that will re-occur in the future.</p>	n/a	n/a	<p>Duration: 39.5 hours</p> <p>Flow: 6,503 MSCF</p> <p>Emissions:</p> <p>SO2 – 11,510 lbs (H2S = 1.72%) NMHC – 960 lbs Methane – 1,144 lbs</p>	Maintenance, Turnaround, Startup, and Shutdown – Equipment Preparation for Maintenance, Equipment Steaming	377-11 N

ESDR No. – Internal document tracking number.

Recurrent Failure – Flaring caused by the recurrent failure of air pollution control equipment, process equipment, or a process to operating in a normal or usual manner. Recurrent is two times or more in a 5 year period. (BAAQMD 12-12-401.4.3)

Attachment H

Date	Process or Equipment Item	Flaring Event Description	Root Cause Finding	Action Item(s)	Proposed Dates/Status	Duration, Flow & Emissions	Consistency with Flare Minimization Plan (12-12-406.3)	ESDR No. Recurrent Failure?
		occurred.						
5/21/2011	MP30 & Unit 200 Shutdown Steaming and Maintenance Preparation	On May 21, 2011 flaring occurred in association with steaming being conducted as part of the Unit 200 Crude/Coker turnaround. The majority of the flow was through the Main Flare 10" line which vents directly to the flare. This resulted in the flaring of unscrubbed gas.	No new prevention measures or corrective actions were identified. The Unit 200 turnaround and associated steaming is a planned activity that will re-occur in the future	n/a	n/a	Duration: 8 hours Flow: 665 MSCF Emissions: SO2 – 473 lbs (H2S = 0.43 %) NMHC – 630 lbs Methane – 38 lbs	Maintenance, Turnaround, Startup, and Shutdown (4.2.1.1) – Equipment Preparation for Maintenance, Equipment Steaming	378-11 N
6/2/2011	Unit 110 Startup	The Unit 110 Hydrogen Production Plant started up on June 2, 2011 after a planned shutdown. Per the Unit 110 start-up SOP, Unit 200 began re-circulating the G-540 Flare Gas Recovery Compressors due to the high volume of hydrogen being sent to the recovery system, which can damage this compressor. The G-503 Flare Gas Compressor had been shutdown prior to this activity and would not have minimized flaring emissions had it been in operation. Flaring of unscrubbed gas occurred during this event.	No new prevention measures or corrective actions were identified. The Unit 110 startup is a planned activity that will re-occur in the future. Due to the unplanned shutdown with the third-party H2 Plants as detailed in the 10/22/10 event the Plant 4 H2 plant was kept in operation for reliability purposes. This resulted in additional Unit 110 Startups and Shutdowns when the plant is long on Hydrogen production in association with other unit shutdowns.	n/a	n/a	Duration: 2.75 hours Flow: 1,060 MSCF Emissions: SO2 – 1,408 lbs (H2S = 0.80%) NMHC – 144 lbs Methane – 105 lbs	Maintenance, Turnaround, Startup, Shutdown – Hydrogen Plant Startups	422-11 N
6/5/2011	Unit 110 Unplanned Shutdown due to SPP Upset	On June 5, 2011 an unplanned shutdown of the Unit 110 Hydrogen Plant occurred. This occurred due to low refinery air pressure which shutdown the Unit 110 Pressure Swing Adsorber. Flaring of unscrubbed gas occurred immediately following the shutdown and then during the startup which was initiated approximately three hours following the shutdown.	Unit operator inadvertently closed the B boiler feed water valves.	Consider conducting an alarm rationalization review and DCS/Display changes to highlight SOLs and allow operators to more readily distinguish between turnins on the DCS displays.	COMPLETED 12/15/2011	Duration: 5 hours Flow: 1,681 SCFD Emissions: SO2 – 1,033 lbs (H2S = 0.37%) NMHC – 274 lbs Methane – 221 lbs	Maintenance, Turnaround, Startup, Shutdown (4.2.1.1) – Hydrogen Plant Startup/Shutdowns	428-11 N
6/8 – 9/2011	Unit 246 Depressuring to MP30 Flare due to Planned Shutdown & Steaming of E-301 and Unit 240 Plant 2	On June 8, 2011 Unit 246 was shutting down for maintenance work. As part of the unit shutdown and in order to prepare for maintenance and entry the unit is depressured and purged. The unscrubbed material is vented directly to the MP-30 Flare. In addition to the Unit 246 shutdown work the Unicracker E-301 exchanger was being steamed to restore its heat transfer rate. When this exchanger is steamed the discharge is vented to blowdown and then to the flare.	No new prevention measures or corrective actions were identified. These two activities were planned maintenance activities that will re-occur in the future.	n/a	n/a	Main and MP30 Flare Totals Duration: 26.50 hours Flow: 1,288 SCFD Emissions: SO2 – 3,833 lbs (H2S = 1.86%) NMHC – 166 lbs Methane – 119 lbs	Maintenance, Turnaround, Startup, and Shutdown – Equipment Preparation for Maintenance, Equipment Steaming Maintenance, Turnaround, Startup, and Shutdown – Equipment Preparation for Maintenance, Depressuring and Purging	424-11 N

ESDR No. – Internal document tracking number.

Recurrent Failure – Flaring caused by the recurrent failure of air pollution control equipment, process equipment, or a process to operating in a normal or usual manner. Recurrent is two times or more in a 5 year period. (BAAQMD 12-12-401.4.3)

Attachment H

Date	Process or Equipment Item	Flaring Event Description	Root Cause Finding	Action Item(s)	Proposed Dates/Status	Duration, Flow & Emissions	Consistency with Flare Minimization Plan (12-12-406.3)	ESDR No. Recurrent Failure?
6/20 – 21/2011	Unit 246 and Unicracker Startup Associated Flaring and G-540 Startup Issue	On June 20, 2011 Unit 246 was starting up after being shutdown for maintenance work. During the startup materials from the unit are sent to blowdown until they are on-grade. There were numerous other units startups taking place on this day including the Unit 200 Coker/Crude Complex and MP-30 Complex. During these unit startups and while the Unit 246 materials were sent to blowdown flaring of unscrubbed gas occurred	G-540 common discharge pressure setpoint change.	Return setpoint from 70 to 80 psig.	COMPLETED	Duration: 23.25 hours Flow: 830 MSCF Emissions: SO2 – 4,981 lbs (H2S = 3.6%) NMHC – 406 lbs Methane – 146 lbs	Maintenance, Turnaround, Startup, and Shutdown – High Base Load Upset/Malfunction – Loss of a Compressor	429-11 N

ESDR No. – Internal document tracking number.

Recurrent Failure – Flaring caused by the recurrent failure of air pollution control equipment, process equipment, or a process to operating in a normal or usual manner. Recurrent is two times or more in a 5 year period. (BAAQMD 12-12-401.4.3)

2010 (through June 30, 2010) Flaring Event Summary & Categorization

Category	Primary Cause	Volume (MMSCF)	SO2 (tpy)	Total Duration (Hours)	Average Rate (MSO/FH)	Count	Count Requiring RCA	Rank (volume basis)	Volume Percentage (%)
Process Unit Shutdown	Quality	0.16	0.10	2.77	30	7		5	1.6%
Utility Upset (steam, electricity, air)	Quantity	0.00	0.00	0.00	n/a	0		n/a	0.0%
U110 SU/SD	Quality	5.16	2.21	18.90	1,103	3	3	1	51.0%
G-503 Compressor Preventative Maintenance (PM)	Quantity - No Recovery	0.00	0.00	0.00	n/a	0		n/a	0.0%
G-503 Compressor Malfunction	Quantity - No Recovery	0.00	0.00	0.00	n/a	0		n/a	0.0%
Process Unit Startup	Quality	0.04	0.00	0.53	3	2		6	0.4%
Process Unit Malfunction	Quantity	1.13	0.68	9.58	152	7	1	3	11.2%
All Others	Various	0.01	0.00	0.32	1	3		9	0.1%
G-503 Compressor Capacity Exceedance	Quantity	0.03	0.01	1.00	1	9		8	0.3%
Process Unit / Vessel Purging	Quality	0.04	0.00	2.30	0	1		7	0.4%
G-501 Compressor Preventative Maintenance	Quantity	0.00	0.00	0.00	n/a	0		n/a	0.0%
G-501 Unplanned SD	Quantity - No Recovery	0.00	0.00	0.00	n/a	0		n/a	0.0%
Major Turnaround - Flare, Units, G-503	Quality	0.00	0.00	0.00	n/a	0		n/a	0.0%
Fuel Gas Imbalance	Quantity	3.25	0.22	68.67	26	16		2	32.1%
Third Party H ₂ Plant Shutdown/Startup	Quantity/Quality	0.31	0.36	4.78	182	3	1	4	3.0%
Total		10.13	3.59	108.85		51	5		100%

Root Cause Analysis Breakdown	Volume (MMSCF)	Count	SO2 (tons)
Events Requiring Root Cause Analysis	8.12	5	3
Events w/ Volume <500,000 SCFD or <500 lbs SO2	2.01	46	0
Totals	10.13	51	4

2009 Flaring Event Summary & Categorization

Category	Primary Cause	Volume (MMSCF)	SO2 (tpy)	Total Duration (Hours)	Average Rate (MSCF/H)	Count	Count Requiring RCA	Rank (Volume Basis)	Volume Percentage (%)
Process Unit Shutdown	Quality	0.14	0.06	2.82	63	2		9	0.1%
Utility Upset (steam, electricity, air, etc.)	Quantity	0.05	0.04	0.30	85	1		10	0.0%
U110 SU/SD	Quality	2.95	2.20	7.93	1,468	2	2	5	1.9%
G-503 Compressor Preventative Maintenance (PM)	Quantity - No Recovery	0.00	0.00	0.00	n/a	0		n/a	0.0%
G-503 Compressor Malfunction	Quantity - No Recovery	0.00	0.00	0.00	n/a	0		n/a	0.0%
Process Unit Startup	Quality	2.14	0.40	24.13	58	13	1	6	1.3%
Process Unit Malfunction	Quantity	12.89	4.42	77.92	421	20	7	3	8.1%
All Others	Various	1.70	0.14	44.50	13	22		7	1.1%
G-503 Compressor Capacity Exceedance	Quantity	0.45	0.32	11.97	34	19		8	0.3%
Process Unit / Vessel Purging	Quality	18.65	1.38	60.47	251	11	2	2	11.8%
G-501 Compressor Preventative Maintenance	Quantity	0.00	0.00	0.00	n/a	0		n/a	0.0%
G-501 Unplanned SD	Quantity - No Recovery	0.00	0.00	0.00	n/a	0		n/a	0.0%
Major Turnaround - Flare, Units, G-503	Quality	107.26	141.64	334.70	70,822	4	2	1	67.6%
Fuel Gas Imbalance	Quantity	12.38	0.05	228.67	5	15	2	4	7.8%
Third Party H ₂ Plant Shutdown/Startup	Quantity/Quality	0.00	0.00	0.00	n/a	0		n/a	0.0%
Total		158.62	151	793.41		109	16		100%

Root Cause Analysis Breakdown	Volume (MMSCF)	Count	SO2 (tons)
Events Requiring Root Cause Analysis	139.03	16	148
Events w/ Volume <500,000 SCFD or <500 lbs SO2	16.53	93	1
Totals	155.56	109	149

2008 Flaring Event Summary & Categorization

Category	Primary Cause	Volume (MMSCF)	Total Duration (Hours)	Average Rate (MSCF/H)	Count	Count Requiring RCA	Rank (volume basis)	Volume Percentage (%)
Process Unit Shutdown	Quality	0.27	8.30	33	5	1	8	1.1%
Utility Upset	Quantity	0.38	6.43	n/a	5		6	1.6%
U110 SU/SD	Quality	4.55	14.67	317	2	2	3	18.7%
G-503 Compressor Preventative Maintenance (PM)	Quantity - No Recovery	0.00	0.00	n/a	0		n/a	0.0%
G-503 Compressor Malfunction	Quantity - No Recovery	6.48	32.47	19	1	4	2	26.7%
Process Unit Startup	Quality	0.33	2.67	105	2		7	1.3%
Process Unit Malfunction	Quantity	4.19	21.40	46	10	3	4	17.3%
All Others	Various	0.06	2.30	19	4		9	0.2%
G-503 Compressor Capacity Exceedance	Quantity	1.43	50.95	13	64		5	5.9%
Process Unit / Vessel Purging	Quality	6.60	51.12	4,984	5	1	1	27.2%
G-501 Compressor Preventative Maintenance	Quantity	0.00	0.00	n/a	0		n/a	0.0%
G-501 Unplanned SD	Quantity - No Recovery	0.00	0.00	n/a	0		n/a	0.0%
Major Turnaround - Flare, Units, G-503	Quality	0.00	0.00	n/a	0		n/a	0.0%
Total		24.28	190.30		98	11		100%

Root Cause Analysis Breakdown	Volume (MMSCF)	Count	SO2 (tons)
Events Requiring Root Cause Analysis	21.33	7	36
Events w/ Volume <500,000 SCFD or <500 lbs SO2	2.95	91	2
Totals	24.28	98	37

2007 Flaring Event Summary & Categorization

Category	Primary Cause	Volume (MMSCF)	Total Duration (Hours)	Average Rate (MSCF/H)	Count	Count Requiring RCA	Rank (volume basis)	Volume Percentage (%)
Process Unit Shutdown	Quality	2.52	25.98	56	5	1	3	5.8%
Utility Upset	Quantity	1.71	4.80	418	5	1	5	4.0%
U110 SU/SD	Quality	1.49	5.92	252	1	1	6	3.5%
G-503 Compressor Preventative Maintenance (PM)	Quantity - No Recovery	12.80	216.32	61	1	1	2	29.7%
G-503 Compressor Malfunction	Quantity - No Recovery	0.12	1.98	58	3		9	0.3%
Process Unit Startup	Quality	0.02	0.50	42	1		11	0.05%
Process Unit Malfunction	Quantity	22.19	31.50	143	11	1	1	51.4%
All Others	Various	0.15	9.73	24	11		8	0.3%
G-503 Compressor Capacity Exceedance	Quantity	0.19	7.08	24	32		7	0.4%
Process Unit / Vessel Purging	Quality	1.90	24.82	35	6	1	4	4.4%
G-501 Compressor Preventative Maintenance	Quantity	0.00	0.00	n/a	0		n/a	0.0%
G-501 Unplanned SD	Quantity - No Recovery	0.07	0.68	98	1		10	0.2%
Major Turnaround - Flare, Units, G-503	Quality	0.00	0.00	n/a	0		n/a	0.0%
Total		43.15	329.32		77	6		100%

Root Cause Analysis Breakdown	Volume (MMSCF)	Count
Events Requiring Root Cause Analysis	41.82	6
Events w/ Volume <500,000 SCFD or <500 lbs SO2	1.33	71
Totals	43.15	77

2006 Flaring Event Summary & Categorization

Category	Primary Cause	Volume (MMSCF)	Count	Count Requiring RCA	Rank (volume basis)	Volume Percentage (%)
Process Unit Shutdown	Quality	6.84	9	4	4	9.7%
Utility Upset	Quantity	2.19	2	2	5	3.1%
U110 SU/SD	Quality	1.35	1	1	8	1.9%
G-503 Compressor Preventative Maintenance (PM)	Quantity - No Recovery	11.22	3	2	3	15.9%
G-503 Compressor Malfunction	Quantity - No Recovery	0.80	4	1	9	1.1%
Process Unit Startup	Quality	1.96	3	2	7	2.8%
Process Unit Malfunction	Quantity	18.21	9	1	2	25.8%
All Others	Various	2.03	15	1	6	2.9%
G-503 Compressor Capacity Exceedance	Quantity	0.27	19		10	0.4%
Process Unit / Vessel Purging	Quality	25.78	2		1	36.5%
G-501 Compressor Preventative Maintenance	Quantity	0.00	0		n/a	n/a
Major Turnaround - Flare, Units, G-503	Quality	0.00	0		n/a	n/a
Total		70.66	67	14		100%

Root Cause Analysis Breakdown	Volume (MMSCF)	Count
Events Requiring Root Cause Analysis	67.73	14
Events w/ Volume <500,000 SCFD or <500 lbs SO2	2.93	53
Totals	70.66	67

2005 Flaring Event Overview & Categorization

Category	Primary Cause	Volume (MMSCF)	Total Duration (Hrs)	Avg Rate (MSCF/H)	Count	Count Requiring RCA	Rank (vol basis)	Volume Percentage (%)
Process Unit Shutdown	Quality	39.13	209	168	5	4	1	66.9%
Process Unit / Vessel Purging	Quality	5.16	70	52	9	2	2	8.8%
G-501 Compressor Preventative Maintenance	Quantity	4.50	25	180	1	1	3	7.7%
Process Unit Startup	Quality	2.71	27	93	1		4	4.6%
U110 SU/SD	Quality	2.09	18	129	3	3	5	3.6%
Process Unit Malfunction	Quantity	2.02	14	81	9	1	6	3.5%
G-503 Compressor Preventative Maintenance (PM)	Quantity - No Recovery	1.47	33	55	3	1	7	2.5%
G-503 Compressor Capacity Exceedance	Quantity	0.95	17	108	24		8	1.6%
G-503 Compressor Malfunction	Quantity - No Recovery	0.25	11	38	5		9	0.4%
All Others	Various	0.15	10	239	4		10	0.3%
Utility Upset	Quantity	0.04	3	13	1		11	0.1%
Major Turnaround - Flare, Units, G-503	Quality	0.00	0		0			
Total		58.46	437		65	12		100.0%

Root Cause Analysis Breakdown	Volume (MMSCF)	Count
Events Requiring Root Cause Analysis	55.19	12
Events w/ Volume <500,000 SCFD or <500 lbs SO2	3.28	53
Totals	58.46	65

2004 Flaring Event Overview & Categorization

Category	Primary Cause	Volume (MMSCF)	Duration (Hours)	Rate (MSCFH)	Count	Rank (vol basis)	Volume Percentage (%)
Major Turnaround - Flare, Units, G-503	Quality	138.53	244	583	1	1	59%
Process Unit Shutdown	Quality	81.14	332	186	2	2	34.6%
Process Unit Startup	Quality	6.08	59	100	1	3	2.6%
Process Unit Malfunction	Quantity	5.13	82	54	3	4	2.2%
G-503 Compressor Preventative Maintenance (PM)	Quantity - No Recovery	2.34	27	64	2	5	1.0%
G-503 Compressor Capacity Exceedance	Quantity	0.89	31	34	34	6	0.4%
U110 SU/SD	Quality	0.14	4	36	1	7	0.1%
Process Unit / Vessel Purging	Quality	0.08	2	40	1	8	0.0%
Utility Upset	Quantity	0.03	2	15	1	9	0.0%
G-503 Compressor Malfunction	Quantity - No Recovery	0.00	0		0		
G-501 Compressor Preventative Maintenance	Quantity	0.00	0		0		
All Others	Various	0.00	0		0		
Total		234.37	783		46		100%

Root Cause Analysis Breakdown	Volume (MMSCF)	Count
Events Requiring Root Cause Analysis	230.87	5
Events w/ Volume <500,000 SCFD or <500 lbs SO2	3.50	41
Totals	234.37	46

Flare Minimization Plan, BAAQMD 12-12
ConocoPhillips, San Francisco Refinery
BAAQMD Plant 16

ATTACHMENT I

STORAGE, TREATMENT, & RECOVERY SCHEMATIC

Flare Gas Recovery With Storage Sphere

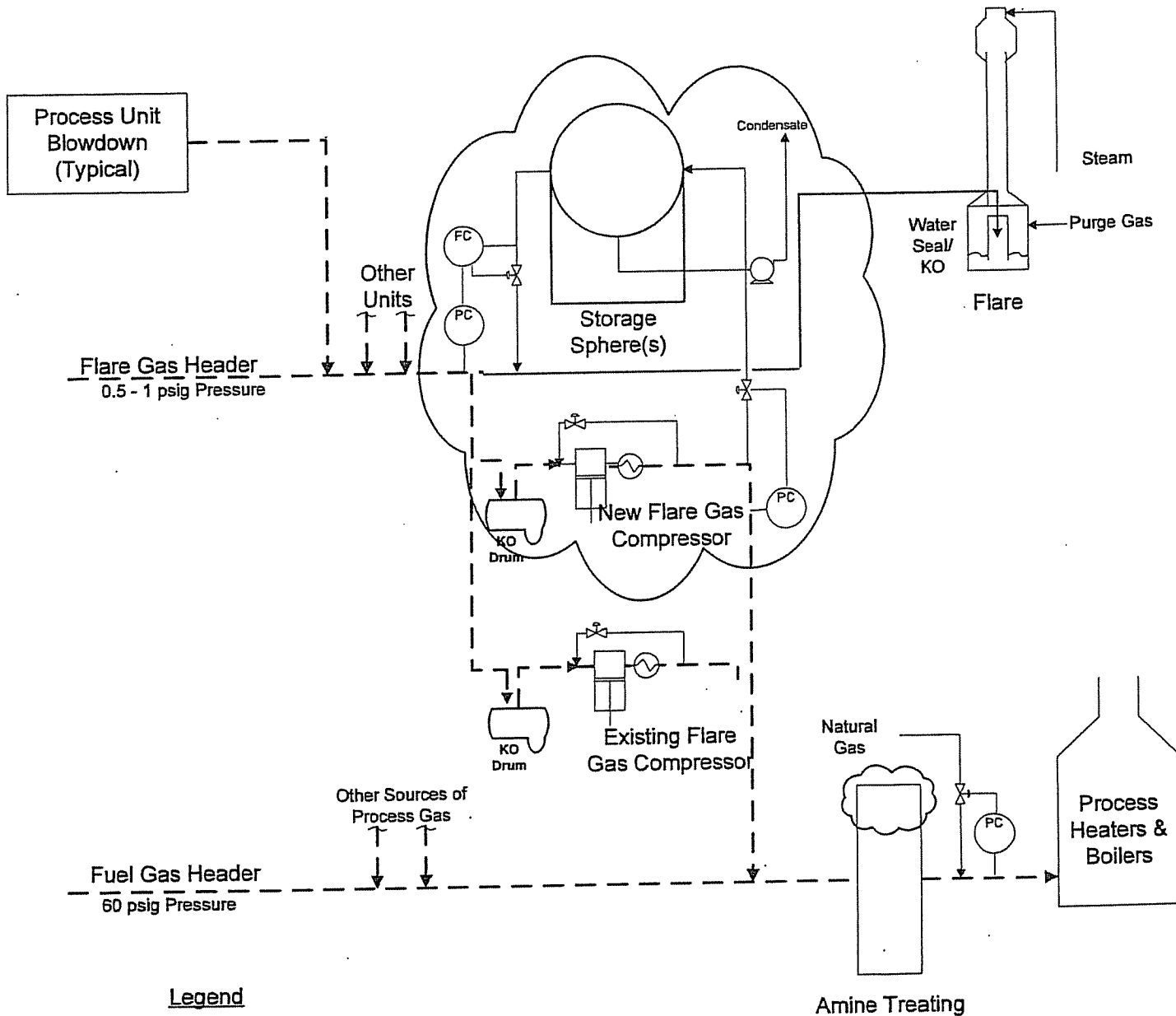

Flare Minimization Plan, BAAQMD 12-12
ConocoPhillips, San Francisco Refinery
BAAQMD Plant 16

ATTACHMENT J

(Reserved)

Attachment K
Flare Construction

Flare	Main Flare	MP30 Flare
Source No.	(S-296)	(S-398)
Flare Height	250' – See Att. C	225' – See Att C
Pipe Diameter	5' – See Att C	4' – See Att C
Number of Pilots	4 – See Section 2.2.3.1	4 – See Section 2.2.3.2
Number of Steam Injection Nozzles	2 steam injection headers (2" & 6") and a Callidus BTZ-US upper steam flare tip.	2 steam injection headers (3" & 6") and a Callidus BTZ-IS3 multiple internal steam injection system.
Capacity ¹	842 ton/hr	445 ton/hr
Date of Construction	1970 approx , Tip Replaced 1996	2000
Location of Purge Gas Insertion	See Attachment B, Section titled "Main Flare Purge Gas Requirements" for details. See also Att C for placement on PFD.	See Attachment B, Section titled "MP-30 Flare Operation" for details. See also Att C for placement on PFD.

¹ Capacity provided is based on expected flow from total power failure. Flare system likely able to handle larger flow. Main design factor for flare tip diameter is gas exit velocity. Generally, flares are sized to permit a velocity of up to 0.5 Mach for short-term, peak, conditions with 0.2 Mach for normal conditions.

Attachment L

Compressor Capacity & Monitoring Description

G-503 Flare Gas Recovery Compressor	
Brand	Bessemer-Cooper
Name	JM-2 Compressor Unit
Serial Number	48321
Type	Reciprocating
Date of Operation	Mid 1970's (approximation)
Capacity	4.75 MMSCF/D & 165 PSI (Vapor Recovery Service) 9.55 MMSCF/D (Wet Gas Service)
HP Rating	1000 HP

G-540 A/B/C Liquid Ring Flare Gas Recovery Compressors	
Brand	Garco
Name	AB 1500 F1
Serial Number	6103 (200G540A), 6104 (200G540B), 6105 (200G540C)
Type	Liquid Ring
Date of Operation	August 2009 (approximate)
Capacity	4.8 MMSCF/D Vapor Recovery Service at 15.7 psia and 110 °F (combined capacity of three compressors)
HP Rating	600 BHP each

Compressor & Fuel Gas Compatibility Specification Monitoring

Monitoring is conducted at Unit 200 on the Flare Gas Recovery Compressor. The primary drivers are specific gravity monitoring and compressor loading. Both give indications of changes in the fuel gas composition (e.g. low specific gravity indicates increased H₂, increased loading at compressor indicates higher N₂ level in system). Prior to recovered gasses being sent to U233, if significant composition changes occur the change is mitigated by the addition of supplemental gasses. If the gas addition does not mitigate the adverse effects then the flare gas compressor is placed into recirculation or shutdown and gasses are diverted to flare. See compressor monitoring information for more details on parameters monitored.

Monitoring of fuel gas heating value is a secondary means for ensuring fuel gas specifications are met. Fuel gas is monitored with a Houston-Atlas H₂S analyzer, Wobbe Heating Value Analyzer, and specific gravity (SG) analyzers. Fuel gas gravity is monitored to allow operation within a desired range (not hard limits). Generally, at the Flare Gas Recovery Compressor, SG lower than 0.6 is not desired due to low heating value to sustain good operation. SG higher than 1.12 must be avoided to prevent condensation of liquids (C₄) in the fuel gas system. Fuel gas composition is adjusted through the addition or reduction of supplemental gasses such as butane and natural gas to ensure fuel quality is met.

Attachment M

Fuel Gas System Overview

The fuel gas system is composed of three major components. Unit 233 Fuel Gas Cleanup, Unit 215 Merichem and Unit 246/Air Liquide Fuel Gas (RFG B). Unit 233 receives sour gas streams and cleans them up for re-use in facility combustion devices (refinery heaters and the Steam Power Plant Turbines). The feeds to Unit 233 include gasses from:

- G-503 Flare Gas Recovery Compressor
- Unit 200 Odor Abatement Compressor
- Unit 200 Light Ends, primarily composed of gasses from G-501 Wet Gas Compressor
- Unicracker Sour Gas Make
- Units 228, 230, 231, & 215 Sour Gas

Once these gasses are cleaned, butane and natural gas is added to supplement the fuel supply. The primary considerations for fuel include pressure, sulfur content, specific gravity, and BTU content. The normal operating range for fuel gas pressure is 72 to 74 psig. The pressure is continuously monitored. As the pressure decreases below the desired pressure natural gas is automatically added. All the heaters at the facility are subject to EPA's New Source Performance Standard (NSPS) Subpart J for combustion devices. This requires that the fuel fired to the heater not have Hydrogen Sulfide (H₂S) content greater than 162 ppmv. An H₂S analyzer is in place to continuously measure H₂S content to ensure compliance with the limit.

Additionally, the heaters at the facility are subject to a Sulfur Dioxide (SO₂) bubble as described in the Plant 16 Title V Permit Condition No. 1694. This requires that the fuel gas be sampled for Total Reduced Sulfur (TRS) three (3) times per day and that speciated sulfur sampling be performed on a monthly basis in order to calculate the SO₂ emissions associated with combustion. Specific gravity (sg) monitoring is the primary means in which gas quality is assured. Adjustments are made to the amount of butane added to fuel gas to control specific gravity. There are continuous specific gravity analyzers in a number of fuel gas headers throughout the refinery. As a secondary means of monitoring there is a Wobbe analyzer which determines the higher heating value (HHV) of the fuel gas. Attachment L and Section 2.2.3.3 provides details as to the type of monitoring performed at the Flare Gas Compressor. This gas is more variable than the other feeds to Unit 233. As described in Attachment L, the flare gas recovery compressor is shutdown if the gasses being sent to the compressor are not suitable for recovery.

A slip stream from U233, after cleanup, is sent to Unit 215 Merichem for further sulfur removal. There are two heaters on site which have more stringent sulfur standards for our Ultra Low Sulfur Diesel Project requiring the fuel from Unit 233 to undergo further sulfur removal. Lastly, as part of our Clean Fuels Project we have an additional lower sulfur standard for the fuel being sent to Unit 246. This fuel termed RFG B can be a blend of natural gas, U233 gas, U215 fuel gas, and Unicracker Sweet Gas (RFG A). The Unicracker Sweet Gas is depicted on the fuel gas diagram. This is a low H₂S content gas that comes off of the Unit 240-4 D-401 H₂S Absorber. It is also used as hydrogen plant feed gas.

See the drawing contained in this section for a schematic of the fuel gas system. The schematic illustrates the primary gas producers and consumers. The main consumers can be grouped as follows based on fuel supply:

- Refinery Heaters – U233 Fuel Gas
- New Refinery Heaters at Unit 200 & U250 (post-2004) – U215 Merichem
- Steam Power Plant – U233 Fuel Gas, Natural Gas, Unicracker Sweet Gas
- Unit 110 Hydrogen Plant Furnace H-1 - U233 Fuel Gas, Natural Gas, Unicracker Sweet Gas
- Unit 246 Heater – RFG B Fuel Gas or individual fuel components

Flare Minimization Plan, BAAQMD 12-12
ConocoPhillips, San Francisco Refinery
BAAQMD Plant 16

Attachment N

Cost Effectiveness Calculation Background Material

Flare Minimization Plan, BAAQMD 12-12
ConocoPhillips, San Francisco Refinery
BAAQMD Plant 16

Cost Curves for Major Equipment

Flare Gas Storage Options

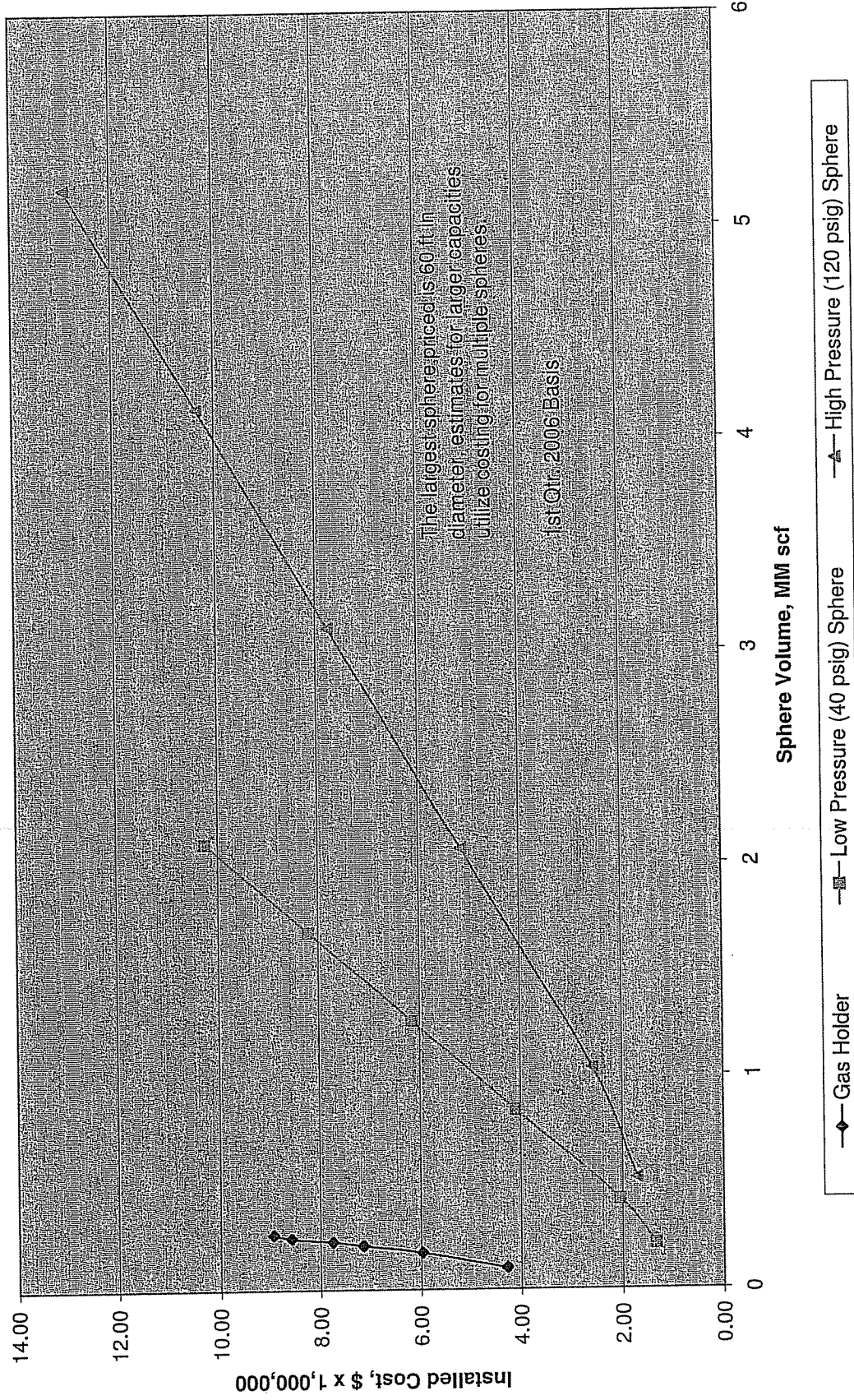

Flare Gas Compressor System Costs

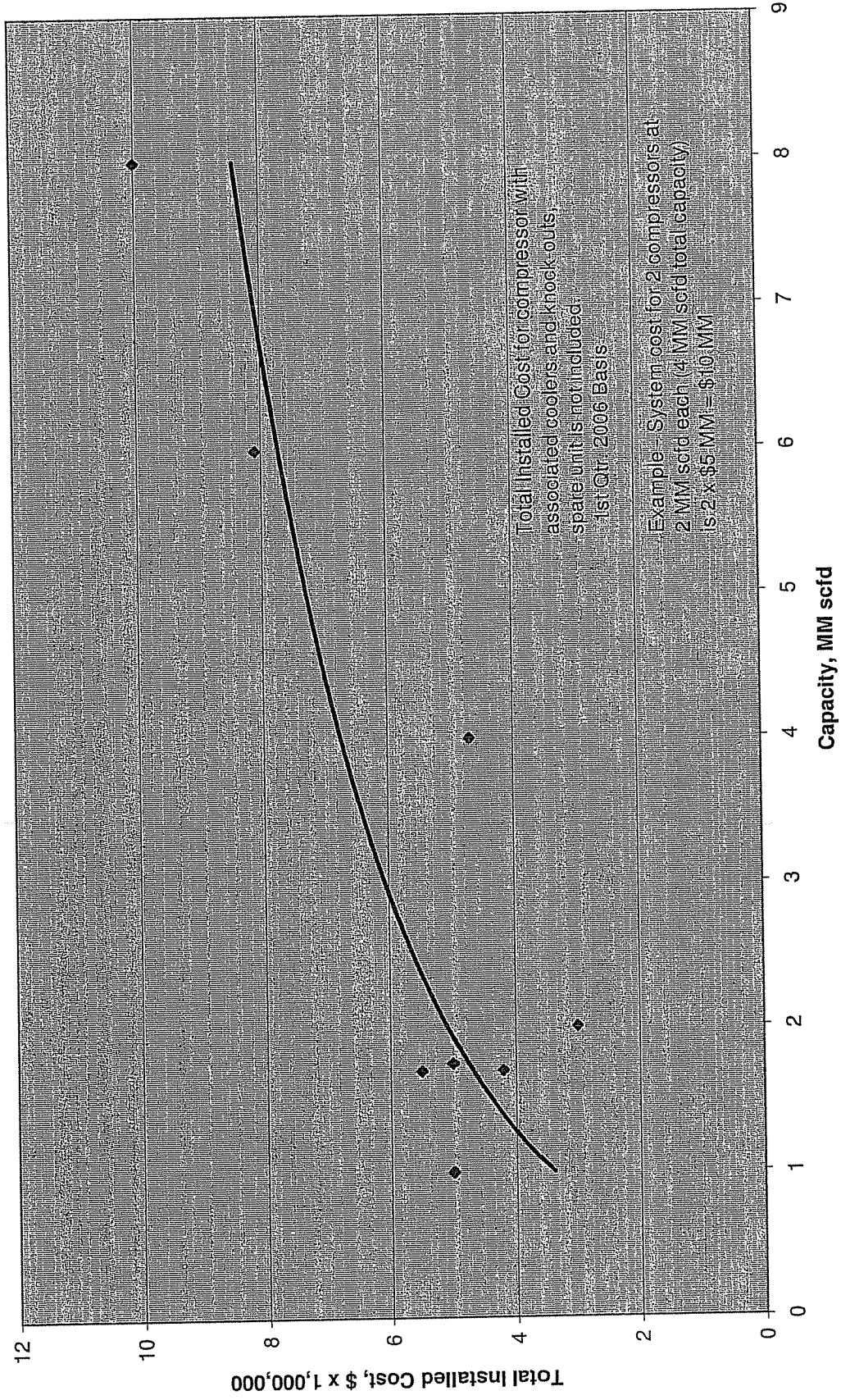

Fuel Gas Amine Treater Costs

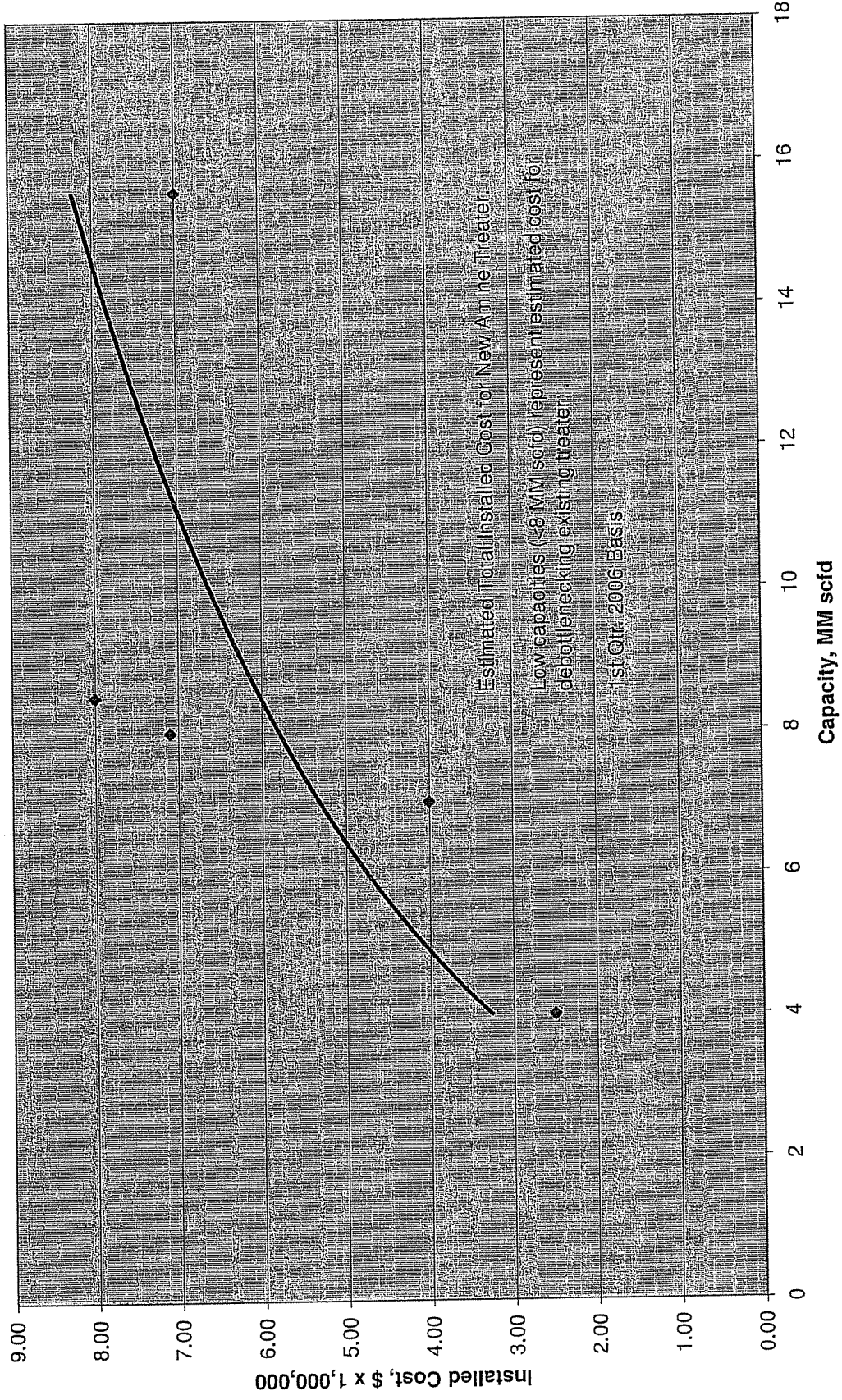

ENSR

2 Technology Park Drive, Westford, Massachusetts, 01886-3140
 T 978.589.3000 F 978.589.3100 www.ensr.aecom.com

Telephone Call Summary

By:	Tom Sudol	Date:	5/11/06
Talked with:	Ken Petro	Project number:	07230-018
From (company):	Chicago Bridge & Iron	Project name:	Flare Minimization Plan
Phone number:	302-325-8407	Subject:	Spherical Storage Tank Costs

Distribution:

Message

Ken Petro called to respond to my budgetary price quote request.

A 60-ft diameter sphere operating at 40 psig would cost \$1,550,000. Another \$60,000 can be added for painting, and another \$200,000 can be added for the foundation (foundation was estimated based on the general locations of the refineries, and the earthquake zone that they are located in). This tank would be a Div. I tank. The total installed cost of this tank is \$1,810,000.

A 60-ft diameter sphere operating at 120 psig would cost \$2,100,000. The painting and foundation costs would remain the same, bringing the total installed cost of the tank to \$2,360,000. This tank would be a Div. II tank.

All prices quoted over the phone are +/- 25%.

To stress relieve (heat treat) the spheres, costs would increase as follows:

40 psi sphere, 60 ft diameter
 \$1,790,000 installed cost (up from \$1,550,000), not including:
 \$200,000 foundation (unchanged)
 \$60,000 painting (unchanged)

60 psi sphere, 60 ft diameter
 \$2,325,000 installed cost (up from \$2,100,000), not including:
 \$200,000 foundation (unchanged)
 \$60,000 painting (unchanged)

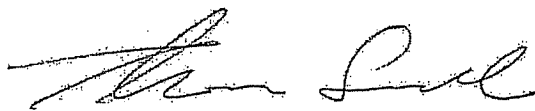

Signature

Flare Minimization Plan, BAAQMD 12-12
ConocoPhillips, San Francisco Refinery
BAAQMD Plant 16

Cost Effective & Emission Calculations for
Storage, Treatment, and Recovery Cases 1 - 4

Storage, Treatment, & Recovery Scenario - Emission Reduction & Cost Effective Analysis

Case	Estimated Potential Reductions (tons/yr)				Cost Effective Basis (tons)	Cost of Control (\$)	Annualized Cost of Abatement System (\$)	Cost Effectiveness Basis (\$/ton)
	VOC	SO ₂	Nox	PM				
1	-0.15	-0.62	-0.02	-0.19	-0.98	\$ 3,250,000	\$ 1,061,000	\$ (1,084,092)
2	-1.12	-4.51	-0.13	-1.38	-7.16	\$ 7,500,000	\$ 2,508,000	\$ (350,420)
3	-1.57	-6.35	-0.19	-1.94	-10.07	\$ 23,400,000	\$ 6,195,000	\$ (615,476)
4	-2.02	-8.18	-0.24	-2.51	-12.97	\$ 23,400,000	\$ 6,195,000	\$ (477,509)

Cost/Benefit Analysis for Flare Minimization

Case: Installation of Small Compressor to Capture Brief Peak Loads
1.5 MMSCFD Compressor - Eliminate Brief Peak Loading (100% of 2005)
 Basis is BAAQMD Guidelines for calculation of cost-effectiveness for BACT
 using the "levelized cash flow method"

$$\text{Cost Effectiveness} = \frac{\text{Annualized Cost of Abatement System (\$/yr)}}{\text{Reduction in Annual Pollutant Emissions (ton/yr)}}$$

Reduction in Annual Pollutant Emissions =
 Baseline Uncontrolled Emissions
 - Control Option Emissions

Reduction in Annual Pollutant Emissions =
 1,954 lb/yr emissions of POG, NOx, CO, & SO2
 0.98 tons/yr

Total Capital Cost	\$3,250,000
CRF = Capital Recovery Factor (to annualize capital cost)	
CRF = $[i(1+i)^n] / [(1+i)^n - 1]$	
i = interest rate, at 0.06	
n = lifetime of abatement system, at 10 yrs	
CRF = 0.1359	

Utilities

Power	400 bhp for flare gas compressor
	0.85 efficiency at design
	351.1 kw
	0.10 \$/kw
	8,760 operating hours per year
	<u>\$307,528 /yr</u>

Annual Costs =
 Direct Costs + Indirect Costs

Direct Costs		<u>\$/year</u>
Labor	2 % of capital cost	65,000
Raw Materials		0
Replacement Parts at	2 % of capital cost	65,000
Utilities (power)		<u>307,528</u>
Total		\$437,528

Indirect Costs		<u>\$/year</u>
Overhead at	80 % of Labor costs	52,000
Property Tax at	1 % of Total Capital Cost	32,500
Insurance at	1 % of Total Capital Cost	32,500
General and Admin. at	2 % of Total Capital Cost	65,000
Capital Recovery at CRF x Total Capital Cost		<u>441,571</u>
Total		\$623,571

Annualized Cost of Abatement System = \$1,061,000

Cost Effectiveness =	\$1,086,000 per ton
----------------------	---------------------

Case No.	Control Method	Flow (MMSCFD)	CO (TPM)	SO ₂ (TPM)	NOx (TPM)	CO (TPM)	PM (TPM)
Case 1	Add Small 16 MMSCFD Compressor	58.46	9.59	39.75	2.19	11.90	0.32
Baseline: Total Flow to Flare (0.946)							
Flow Captured, Routed to Htr 0.003							
Remaining Flow to Flare 9.433							
Total Emissions - Post Control 9.44							
Emission Reduction (0.98) (0.15) (0.62) (0.02) (0.19) (0.00)							

Total Pollutants

Control Method	Flare/Actual	Proposed Flow to Control	Emission Evaluation			Total Emissions	Emission Reduction
			Baseline - Rerouted at Heater	Controlled	Flare		
2005 Baseline Flaring							
Total Volume to Flare (MMSCF/d)	0.25	0.003	0.074	0.158	0.003	0.004	
Total Volume to Flare (MMSCF/yr)	58.462	0.946	57.516	57.516	0.946	0.316	
lb non-methane hydrocarbon (POC) to flare/scf flared gas ¹	0.0164	0.0164	0.0164	0.0164	0.0164	0.32	
lb/yr non-methane hydrocarbon (POC) to flare	958.777	15.514	943.262	943.262	15.514	(0.00)	

Emissions from the Flare

% Destruction of hydrocarbon in flare	98			98			
lb non-methane hydrocarbon (POC) emitted / scf flare gas	0.00033			0.00033			
lb sulfur dioxide (SO ₂) emission / scf flare gas	0.00136			0.00136			
POC: lb/yr non-methane hydrocarbon emissions from flare	19,176			18,865			
POC: ton/yr non-methane hydrocarbon emissions from flare	9.59			9.43			
SO ₂ : lb/yr sulfur dioxide hydrocarbon emissions from flare	79,508			78,222			
SO ₂ : ton/yr sulfur dioxide hydrocarbon emissions from flare	39.75			39.11			
NOx: Nox Emission Factor	0.068 lb/MMBtu						
Flare Gase Heating Value	1,100 Btu/scf						
lb/yr Nox Emissions from Flare	4,373			4,302			
tons/yr Nox from Flare	2.19			2.15			
CO Emission Factor	0.370 lb/MMBtu						
Flare Gase Heating Value	1,100 Btu/scf						
lb/yr CO Emissions from Flare	23,794			23,409			
tons/yr CO from Flare	11.90			11.70			
PM Emission Factor	0.01 lb/MMBtu per BAAQMD email 2/27/07						
lb/yr PM Emissions from Flare	643			633			
tons/yr PM from Flare	0.32			0.32			

Emissions from Heater		99.50%		99.50%		Total	
% Destruction of hydrocarbon in heater		n/a	n/a	n/a	n/a	n/a	n/a
lb non-methane hydrocarbon (POC) emitted / scf flare gas		n/a	0.0000055	0.0000055	0.0000055	5	18,870
Total sulfur (TS) (ppmv) content of scrubbed fuel gas		n/a	325	325	325	0	9.4
POC: lb/yr non-methane hydrocarbon emissions from heater		n/a	5	5	5	52	78,274
POC: ton/yr non-methane hydrocarbon emissions from heater		n/a	0.00	0.00	0.00	0	39.1
SO2: lb/yr sulfur dioxide emissions from heater			51.92	51.92	51.92	34	4,337
SO2: ton/yr sulfur dioxide emissions from heater			0.03	0.03	0.03	0.02	2.17
NOx: Nox Emission Factor Flare Gase Heating Value			0.033 lb/MMBtu				
lb/yr Nox Emissions from Flare			1,100 Btu/scf				
tons/yr Nox from Flare			34 lb/yr				
CO Emission Factor			0.02 tpy				
lb/yr CO Emissions from Flare			100 ppmv				
tons/yr CO from Flare			6.99 lb/yr				
PM Emission Factor			0.0035 tpy				
lb/yr PM Emissions from Flare			7.60 lb/MMScf, AP-42				
tons/yr PM from Flare			7.19 lb/yr				
			0.0036 tpy				

Emissions to the Atmosphere		99.50%		99.50%		Total	
POC: lb/yr	19,176					18,865	5
POC: tpy	9.59					9.43	0
SO2: lb/yr	79,508					78,222	52
SO2: tpy	39.75					39.11	0
NOx: lb/yr	4,373					4,302	34
NOx: tpy	2.19					2.15	0.02
CO: lb/yr	23,794					23,409	7
CO: tpy	11.90					11.70	0.003
PM: lb/yr	643.08					632.68	7.19
PM: tpy	0.32					0.32	0.0036

¹ POC & SO2 levels based on historical sampling data.

Cost/Benefit Analysis for Flare Minimization

Case: Installation of Larger Compressor to Capture Brief Peak Loads & G-503 Maintenance

6.0 MMSCFD Compressor - Eliminate Brief Peak Loading & G-503 PM (100% of 2005)

Basis is BAAQMD Guidelines for calculation of cost-effectiveness for BACT using the "levelized cash flow method"

Reduction in Annual Pollutant Emissions =
 -11,475 lb/yr emissions of POG, NOx, CO, & SO2
 -5.74 tons/yr

Total Capital Cost \$7,500,000

CRF = Capital Recovery Factor (to annualize capital cost)

$$CRF = [i (1 + i)^n] / [(1 + i)^n - 1]$$

i = interest rate, at 0.06

n = lifetime of abatement system, at 10 yrs

CRF = 0.1359

Utilities

Power 1,000 bhp for flare gas compressor
0.85 efficiency at design
877.6 kw
0.10 \$/kw
8,760 operating hours per year
\$768,819 /yr

Annual Costs =
 Direct Costs + Indirect Costs

Direct Costs		<u>\$/year</u>
Labor	2 % of capital cost	150,000
Raw Materials		0
Replacement Parts at	2 % of capital cost	150,000
Utilities (power)		<u>768,819</u>
Total		\$1,068,819

Indirect Costs		<u>\$/year</u>
Overhead at	80 % of Labor costs	120,000
Property Tax at	1 % of Total Capital Cost	75,000
Insurance at	1 % of Total Capital Cost	75,000
General and Admin. at	2 % of Total Capital Cost	150,000
Capital Recovery at CRF x Total Capital Cost		<u>1,019,010</u>
Total		\$1,439,010

Annualized Cost of Abatement System = \$2,508,000

Cost Effectiveness =	-\$437,000 per ton
----------------------	--------------------

Baseline	2005	Proposed	Control	Flow to	SO ₂	NO _x	CO	PM
Flow (MMSCFD)	Flow (MMSCFD)	Flow (MMSCFD)	Flow (MMSCFD)	Flow (MMSCFD)	(TPM)	(TPM)	(TPM)	(TPM)
Baseline: Total Flow to Flare	58.46	9.59	0.019	0.190	39.75	2.19	11.90	0.32
Flow Captured, Routed to Flare (6.918)			0.019	0.126			0.026	0.026
Remaining Flow to Flare	51.544	8.47	8.453	35.050			10.489	0.293
Total Emissions - Post Control	(7.15)	(1.12)	(1.12)	(4.51)			(1.38)	(0.01)
Emission Reduction								

Total Pollutants

Control Method	2005 Baseline Flaring	Flare Actual	Proposed Flow to Control	Emission Evaluation		Total Emissions	Emission Reduction
				Baseline - Rerouted at Heater	Controlled at Heater		
Total Volume to Flare (MMSCF/d)	58.462		0.019	0.141	0.019	0.026	
Total Volume to Flare (MMSCF/yr)			6.918	51.544	6.918	0.026	
lb non-methane hydrocarbon (POC) to flare/scf flared gas ¹	0.0164		0.0164	0.0164	0.0164	0.0164	
lb/yr non-methane hydrocarbon (POC) to flare	958,777		113,455	845,322	113,455	113,455	

Emissions from the Flare

% Destruction of hydrocarbon in flare	98			98			
lb non-methane hydrocarbon (POC) emitted / scf flare gas	0.00033			0.00033			
lb sulfur dioxide (SO ₂) emission / scf flare gas	0.00136			0.00136			
POC: lb/yr non-methane hydrocarbon emissions from flare	19,176			16,906			
POC: ton/yr non-methane hydrocarbon emissions from flare	9.59			8.45			
SO ₂ : lb/yr sulfur dioxide hydrocarbon emissions from flare	79,508			70,100			
SO ₂ : ton/yr sulfur dioxide hydrocarbon emissions from flare	39.75			35.05			
NO _x : Nox Emission Factor	0.068 lb/MMBtu						
Flare Gase Heating Value	1,100 Btu/scf						
lb/yr Nox Emissions from Flare	4,373			3,855			
tons/yr Nox from Flare	2.19			1.93			
CO Emission Factor	0.370 lb/MMBtu						
Flare Gase Heating Value	1,100 Btu/scf						
lb/yr CO Emissions from Flare	23,794			20,978			
tons/yr CO from Flare	11.90			10.49			
PM Emission Factor	0.01 lb/MMBtu per BAAQMD email 2/27/07						
lb/yr PM Emissions from Flare	643			567			
tons/yr PM from Flare	0.32			0.28			

Emissions from Heater		99.50%		99.50%		Total	
% Destruction of hydrocarbon in heater		n/a	n/a	n/a	n/a		
lb non-methane hydrocarbon (POC) emitted heater / scf flare gas		n/a	0.0000055	16,906	38	16,944	-2,231.06
Total sulfur (TS) (ppmv) content of scrubbed fuel gas		n/a	325	8.45	0	8.5	-1.12
POC: lb/yr non-methane hydrocarbon emissions from heater		n/a	38	70,100	380	70,480	-9,028.81
POC: ton/yr non-methane hydrocarbon emissions from heater		n/a	0.02	35.05	0	35.2	-4.51
SO2: lb/yr sulfur dioxide emissions from heater			379.67	3,855	251	4,107	-266.34
SO2: ton/yr sulfur dioxide emissions from heater			0.19	1.93	0.13	2.05	-0.13
NOx: Nox Emission Factor				20,978	51	21,030	-2,764.52
Flare Gase Heating Value				10.49	0.026	10.51	-1.38
lb/yr Nox Emissions from Flare				566.98	52.58	620	-23.52
tons/yr Nox from Flare				0.28	0.0263	0.310	-0.01
CO Emission Factor							
lb/yr CO Emissions from Flare							
tons/yr CO from Flare							
PM Emission Factor							
lb/yr PM Emissions from Flare							
tons/yr PM from Flare							
Emissions to the Atmosphere							
POC: lb/yr		19,176		16,906	38	16,944	-2,231.06
POC: tpy		9.59		8.45	0	8.5	-1.12
SO2: lb/yr		79,508		70,100	380	70,480	-9,028.81
SO2: tpy		39.75		35.05	0	35.2	-4.51
NOx: lb/yr		4,373		3,855	251	4,107	-266.34
NOx: tpy		2.19		1.93	0.13	2.05	-0.13
CO: lb/yr		23,794		20,978	51	21,030	-2,764.52
CO: tpy		11.90		10.49	0.026	10.51	-1.38
PM: lb/yr		643.08		566.98	52.58	620	-23.52
PM: tpy		0.32		0.28	0.0263	0.310	-0.01

Cost/Benefit Analysis for Flare Minimization

Case: Installation of Larger Compressor to Capture Brief Peak Loads & G-503 Maintenance

Range 1 - Conservative Estimate of Gasses to be Recovered

Basis is BAAQMD Guidelines for calculation of cost-effectiveness for BACT using the "levelized cash flow method"

$$\text{Cost Effectiveness} = \frac{\text{Annualized Cost of Abatement System (\$/yr)}}{\text{(Reduction in Annual Pollutant Emissions (ton/yr))}}$$

Reduction in Annual Pollutant Emissions =
 -20,098 lb/yr non-methane hydrocarbon emissions (POC) & SO2
 -10.05 tons/yr

<hr/>		\$23,400,000
Total Capital Cost		
CRF = Capital Recovery Factor (to annualize capital cost)		
CRF = $[i(1+i)^n] / [(1+i)^n - 1]$		
i = interest rate, at	0.06	
n = lifetime of abatement system, at		10 yrs
CRF =	0.1359	

Utilities

Power 1,000 bhp for flare gas compressor
 0.85 efficiency at design
 877.6 kw
 0.10 \$/kw
 8,760 operating hours per year
 \$768,819 /yr

Annual Costs =

Direct Costs + Indirect Costs

Direct Costs		<u>\$/year</u>
Labor	2 % of capital cost	468,000
Raw Materials		0
Replacement Parts at	2 % of capital cost	468,000
Utilities (power)		<u>768,819</u>
Total		\$1,704,819

Indirect Costs

		<u>\$/year</u>
Overhead at	80 % of Labor costs	374,400
Property Tax at	1 % of Total Capital Cost	234,000
Insurance at	1 % of Total Capital Cost	234,000
General and Admin. at	2 % of Total Capital Cost	468,000
Capital Recovery at CRF x Total Capital Cost		<u>3,179,310</u>
Total		\$4,489,710

Annualized Cost of Abatement System = \$6,195,000

Cost Effectiveness =	-\$616,000 per ton
----------------------	--------------------

Case No.	Control Method	Flow (MMSCFD)	POC (lb/day)	SO ₂ (lb/day)	NO _x (lb/day)	CO (lb/day)	PM (lb/day)
3	Add compartmental storage vessel	58.46	9.59	39.75	2.19	11.90	0.32
	Baseline: Total Flow to Flare	(9.729)	0.027	0.267	0.177	0.036	0.037
	Flow Captured, Routed to Htr	48.733	7.992	33.138	1.823	9.917	0.268
	Remaining Flow to Flare		8.02	33.41	2.00	9.95	0.31
	Total Emissions - Post Control	(10.05)	(1.57)	(6.35)	(0.19)	(1.94)	(0.02)
	Emission Reduction						

Total Pollutants

Control Method	2005 Baseline Flaring	Proposed Flow to Control	Emission Evaluation		Total Emissions	Emission Reduction
			Baseline - Rerouted at Heater	Controlled at Heater		
Total Volume to Flare (MMSCF/d)	0.25	0.027	0.134	0.027	0.037	
Total Volume to Flare (MMSCF/y)	58.462	9.73	48.733	9.729	0.037	
lb non-methane hydrocarbon (POC) to flare/scf flared gas	0.0164	0.0164	0.0164	0.0164	0.0164	
lb/yr non-methane hydrocarbon (POC) to flare	958.777	159.557	799.220	159.557	0.0164	
Emissions from the Flare						
% Destruction of hydrocarbon in flare	98		98			
lb non-methane hydrocarbon (POC) emitted / scf flare gas	0.00033		0.00033			
lb sulfur dioxide (SO ₂) emission / scf flare gas	0.00136		0.00136			
POC: lb/yr non-methane hydrocarbon emissions from flare	19,176		15,964			
POC: ton/yr non-methane hydrocarbon emissions from flare	9.59		7.99			
SO ₂ : lb/yr sulfur dioxide hydrocarbon emissions from flare	79,508		66,277			
SO ₂ : ton/yr sulfur dioxide hydrocarbon emissions from flare	39.75		33.14			
NO _x : Nox Emission Factor	0.068 lb/MMBtu		3,645			
Flare Gase Heating Value	1,100 Btu/scf		1.82			
lb/yr Nox Emissions from Flare	4,373		19,834			
tons/yr Nox from Flare	2.19		9.92			
CO Emission Factor	0.370 lb/MMBtu		536			
Flare Gase Heating Value	1,100 Btu/scf		0.27			
lb/yr CO Emissions from Flare	23,794		159.557			
tons/yr CO from Flare	11.90		0.027			
PM Emission Factor	0.01 lb/MMBtu per BAAQMD email 2/27/07		0.027			
lb/yr PM Emissions from Flare	643		0.027			
tons/yr PM from Flare	0.32					

Emissions from Heater		99.50%		99.50%	
% Destruction of hydrocarbon in heater					
lb non-methane hydrocarbon (FOC) emitted heater / scf flare gas	n/a	n/a	0.0000055	325	0.0000055
Total sulfur (TS) (ppmv) content of scrubbed fuel gas	n/a	n/a	54	0.03	54
POC: lb/yr non-methane hydrocarbon emissions from heater	n/a	n/a	533.94	0.27	533.94
POC: ton/yr non-methane hydrocarbon emissions from heater	n/a	n/a	0.00359	0.18 tpy	0.0359 tpy
SO2: lb/yr sulfur dioxide emissions from heater					
SO2: ton/yr sulfur dioxide emissions from heater					
NOx: Nox Emission Factor					
Flare Gase Heating Value					
lb/yr Nox Emissions from Flare					
tons/yr Nox from Flare					
CO Emission Factor					
lb/yr CO Emissions from Flare					
tons/yr CO from Flare					
PM Emission Factor					
lb/yr PM Emissions from Flare					
tons/yr PM from Flare					
Total					

Emissions to the Atmosphere		99.50%		99.50%	
POC: lb/yr	19,176	15,984	54	16,038	-3,137.63
POC: tpy	9.59	7.99	0	8.0	-1.57
SO2: lb/yr	79,508	66,277	534	66,811	-12,697.62
SO2: tpy	39.75	33.14	0	33.4	-6.35
NOX: lb/yr	4,373	3,645	353	3,998	-374.57
NOX: tpy	2.19	1.82	0.18	2.00	-0.19
CO: lb/yr	23,794	19,834	72	19,906	-3,887.86
CO: tpy	11.90	9.92	0.036	9.95	-1.94
PM: lb/yr	643.08	536.06	73.94	610	-33.08
PM: tpy	0.32	0.27	0.0370	0.305	-0.02

Cost/Benefit Analysis for Flare Minimization

Case: Installation of High Pressure Spheres, Compressor, & Amine Treatment

Range 2 - More Aggressive Estimate of Gasses to be Recovered

Basis is BAAQMD Guidelines for calculation of cost-effectiveness for BACT using the "levelized cash flow method"

$$\text{Cost Effectiveness} = \frac{\text{Annualized Cost of Abatement System (\$/yr)}}{\text{Reduction in Annual Pollutant Emissions (ton/yr)}}$$

$$\begin{aligned} \text{Reduction in Annual Pollutant Emissions} = \\ \text{Baseline Uncontrolled Emissions} \\ - \text{Control Option Emissions} \end{aligned}$$

$$\begin{aligned} \text{Reduction in Annual Pollutant Emissions} = \\ -25,905 \text{ lb/yr non-methane hydrocarbon emissions (POC) \& SO}_2 \\ -12.95 \text{ tons/yr} \end{aligned}$$

Total Capital Cost	\$23,400,000
--------------------	--------------

CRF = Capital Recovery Factor (to annualize capital cost)

$$\text{CRF} = [i(1+i)^n] / [(1+i)^n - 1]$$

i = interest rate, at 0.06

n = lifetime of abatement system, at 10 yrs

$$\text{CRF} = 0.1359$$

Utilities

Power	1,000 bhp for flare gas compressor	0.85 efficiency at design	877.6 kw	0.10 \\$/kw	8,760 operating hours per year
					\$768,819 /yr

Annual Costs =

Direct Costs + Indirect Costs

	<u>\\$/year</u>
Direct Costs	
Labor 2 % of capital cost	468,000
Raw Materials	0
Replacement Parts at 2 % of capital cost	468,000
Utilities (power)	<u>768,819</u>
Total	\$1,704,819

	<u>\\$/year</u>
Indirect Costs	
Overhead at 80 % of Labor costs	374,400
Property Tax at 1 % of Total Capital Cost	234,000
Insurance at 1 % of Total Capital Cost	234,000
General and Admin. at 2 % of Total Capital Cost	468,000
Capital Recovery at CRF x Total Capital Cost	<u>3,179,310</u>
Total	\$4,489,710

Annualized Cost of Abatement System =	\$6,195,000
---------------------------------------	-------------

Cost Effectiveness =	-\$478,000 per ton
----------------------	--------------------

Case No.	Case Title	Flow (MMSCF/d)	POC (lb/y)	SO2 (lb/y)	NOx (lb/y)	CO (lb/y)	PM (lb/y)
4	Add compressor and storage vessel	58.46	9.59	39.75	2.19	11.90	0.32
	Eliminate flare peak loading (C-403 Capacity Exceedance) C-503 PM (100% of 2005) portion of maintenance & some emergency vents to be limited (10-30%) Emission basis is 2005 actual event. Rather than vent gas being routed to flare, it	(12.540)	0.034	0.344	0.046	0.046	0.048
	Remaining Flow to Flare	45.922	7.531	31.227	1.717	9.345	0.253
	Total Emissions - Post Control	7.57	31.57	1.95	9.39	0.30	
	Emission Reduction	(12.95)	(2.02)	(8.18)	(0.24)	(2.51)	(0.02)

Total Pollutants

Control Method	2005 Baseline Flaring Flare: Actual	Proposed Flow to Control	Emission Evaluation			Total Emissions	Emission Reduction
			Baseline - Rerouted	Controlled at Heater	Flare Heater		

Total Volume to Flare (MMSCF/d)	0.25	0.034	0.074	0.126	0.034		
Total Volume to Flare (MMSCF/y)	58.462	12.54	45.922	12.540			
lb non-methane hydrocarbon (POC) to flare/scf flared gas ¹	0.0164	0.0164	0.0164	0.0164	0.0164		
lb/yr non-methane hydrocarbon (POC) to flare	958.777	205.658	763.119	205.658			

Emissions from the Flare

% Destruction of hydrocarbon in flare	98			98			
lb non-methane hydrocarbon (POC) emitted / scf flare gas	0.00033			0.00033			
lb sulfur dioxide (SO2) emission / scf flare gas	0.00136			0.00136			
POC: lb/yr non-methane hydrocarbon emissions from flare	19,176			15,062			
POC: ton/yr non-methane hydrocarbon emissions from flare	9.59			7.53			
SO2: lb/yr sulfur dioxide hydrocarbon emissions from flare	79,508			62,454			
SO2: ton/yr sulfur dioxide hydrocarbon emissions from flare	39.75			31.23			
NOx: Nox Emission Factor	0.068 lb/MMBtu						
Flare Gase Heating Value	1,100 Btu/scf						
lb/yr Nox Emissions from Flare	4,373			3,435			
tons/yr Nox from Flare	2.19			1.72			
CO Emission Factor	0.370 lb/MMBtu						
Flare Gase Heating Value	1,100 Btu/scf						
lb/yr CO Emissions from Flare	23,794			18,690			
tons/yr CO from Flare	11.90			9.35			
PM Emission Factor	0.01 lb/MMBtu per BAAQMD email 2/27/07						
lb/yr PM Emissions from Flare	643			505			
tons/yr PM from Flare	0.32			0.25			

Emissions from Heater		99.50%		99.50%		99.50%	
% Destruction of hydrocarbon in heater		n/a	n/a	n/a	n/a	n/a	n/a
lb non-methane hydrocarbon (POC) emitted heater / scf flare gas							
Total sulfur (TS) (ppmv) content of scrubbed fuel gas							
POC: lb/yr non-methane hydrocarbon emissions from heater		n/a	0.0000055	0.0000055	0.0000055	0.0000055	0.0000055
POC: ton/yr non-methane hydrocarbon emissions from heater		n/a	69	69	69	69	69
		n/a	0.03	0.03	0.03	0.03	0.03
SO2: lb/yr sulfur dioxide emissions from heater			688.22	688.22	688.22	688.22	688.22
SO2: ton/yr sulfur dioxide emissions from heater			0.34	0.34	0.34	0.34	0.34
NOx: Nox Emission Factor Flare Gase Heating Value			1,100 Btu/scf	1,100 Btu/scf	1,100 Btu/scf	1,100 Btu/scf	1,100 Btu/scf
lb/yr Nox Emissions from Flare			455 lb/yr	455 lb/yr	455 lb/yr	455 lb/yr	455 lb/yr
tons/yr Nox from Flare			0.23 tpy	0.23 tpy	0.23 tpy	0.23 tpy	0.23 tpy
CO Emission Factor			100 ppmv	100 ppmv	100 ppmv	100 ppmv	100 ppmv
lb/yr CO Emissions from Flare			92.64 lb/yr	92.64 lb/yr	92.64 lb/yr	92.64 lb/yr	92.64 lb/yr
tons/yr CO from Flare			0.0463 tpy	0.0463 tpy	0.0463 tpy	0.0463 tpy	0.0463 tpy
PM Emission Factor			7.60 lb/MMScf, AP-42	7.60 lb/MMScf, AP-42	7.60 lb/MMScf, AP-42	7.60 lb/MMScf, AP-42	7.60 lb/MMScf, AP-42
lb/yr PM Emissions from Flare			95.30 lb/yr	95.30 lb/yr	95.30 lb/yr	95.30 lb/yr	95.30 lb/yr
tons/yr PM from Flare			0.0477 tpy	0.0477 tpy	0.0477 tpy	0.0477 tpy	0.0477 tpy
Emissions to the Atmosphere							
POC: lb/yr		19,176	15,062	15,062	69	15,131	-4,044.19
POC: tpy		9.59	7.53	7.53	0	7.6	-2.02
SO2: lb/yr		79,508	62,454	62,454	688	63,142	-16,366.35
SO2: tpy		39.75	31.23	31.23	0	31.6	-8.18
NOx: lb/yr		4,373	3,435	3,435	455	3,890	-482.79
NOx: tpy		2.19	1.72	1.72	0.23	1.95	-0.24
CO: lb/yr		23,794	18,690	18,690	93	18,783	-5,011.19
CO: tpy		11.90	9.35	9.35	0.046	9.39	-2.51
PM: lb/yr		643.08	505.14	505.14	95.30	600	-42.64
PM: tpy		0.32	0.25	0.25	0.0477	0.300	-0.02