

# Black and Brown Carbon Aerosols: Nanoparticles and Mega-Problems

Michael T. Kleinman

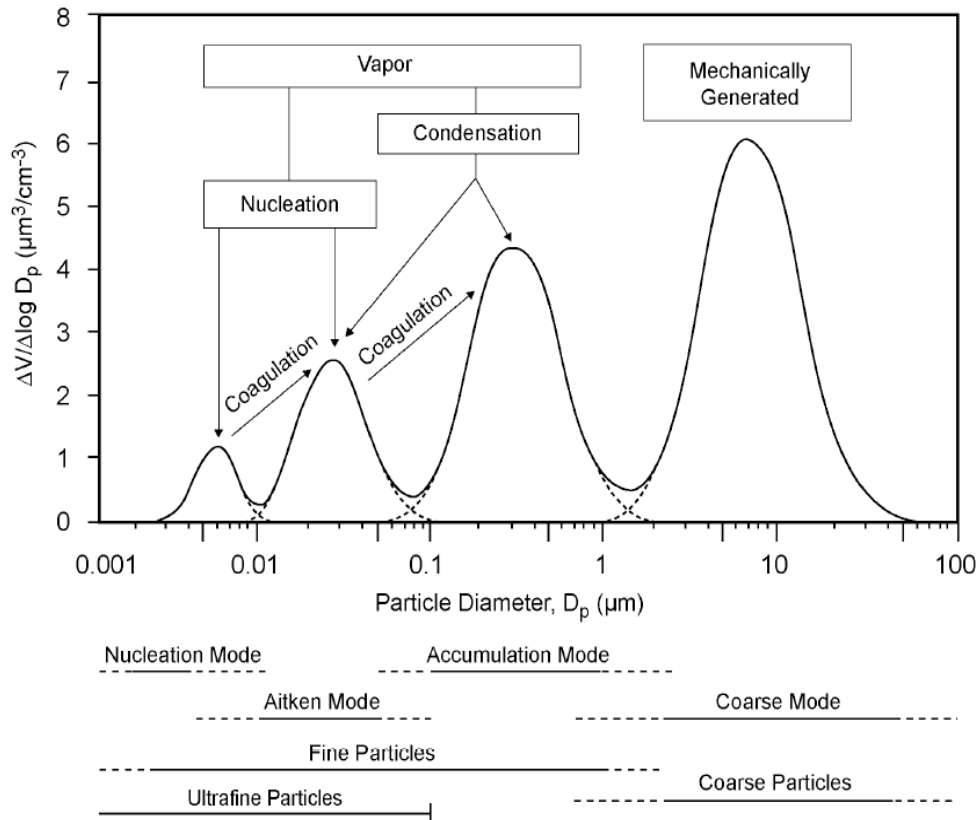
Department of Medicine

University of California, Irvine

# Outline

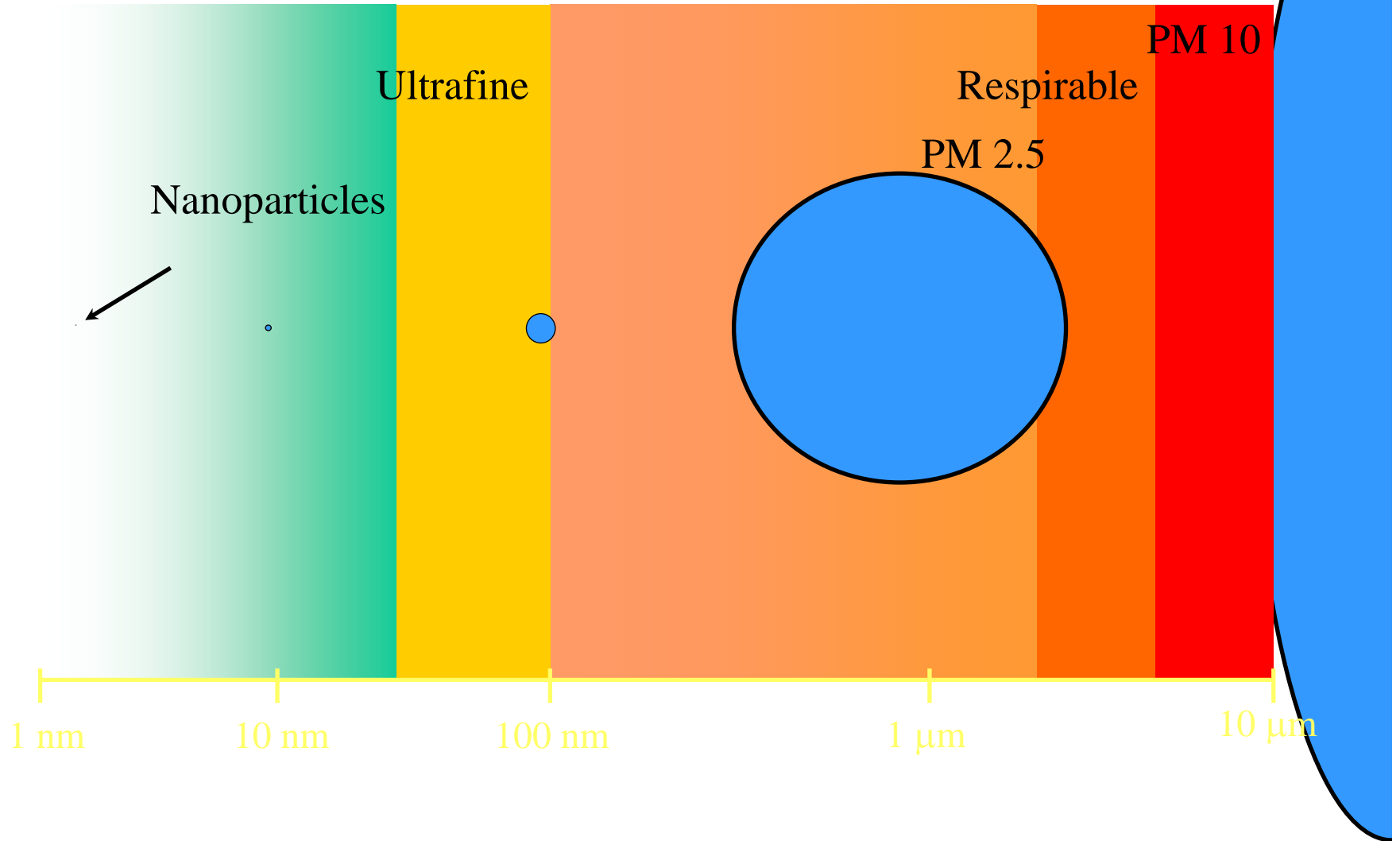
- Brief Overview of Nanoparticles
- Potential Exposure Routes, Retention and Deposition Patterns
- Characteristics of Black and Brown Carbon
- Interactions With Cells
- Translocation From Lung
- Ambient vs. Engineered Nanoparticles
- Health Effects – The Heart

# Much of our thinking about nanoparticles stems from our knowledge of traffic-related particulate matter (EPA, 2004)

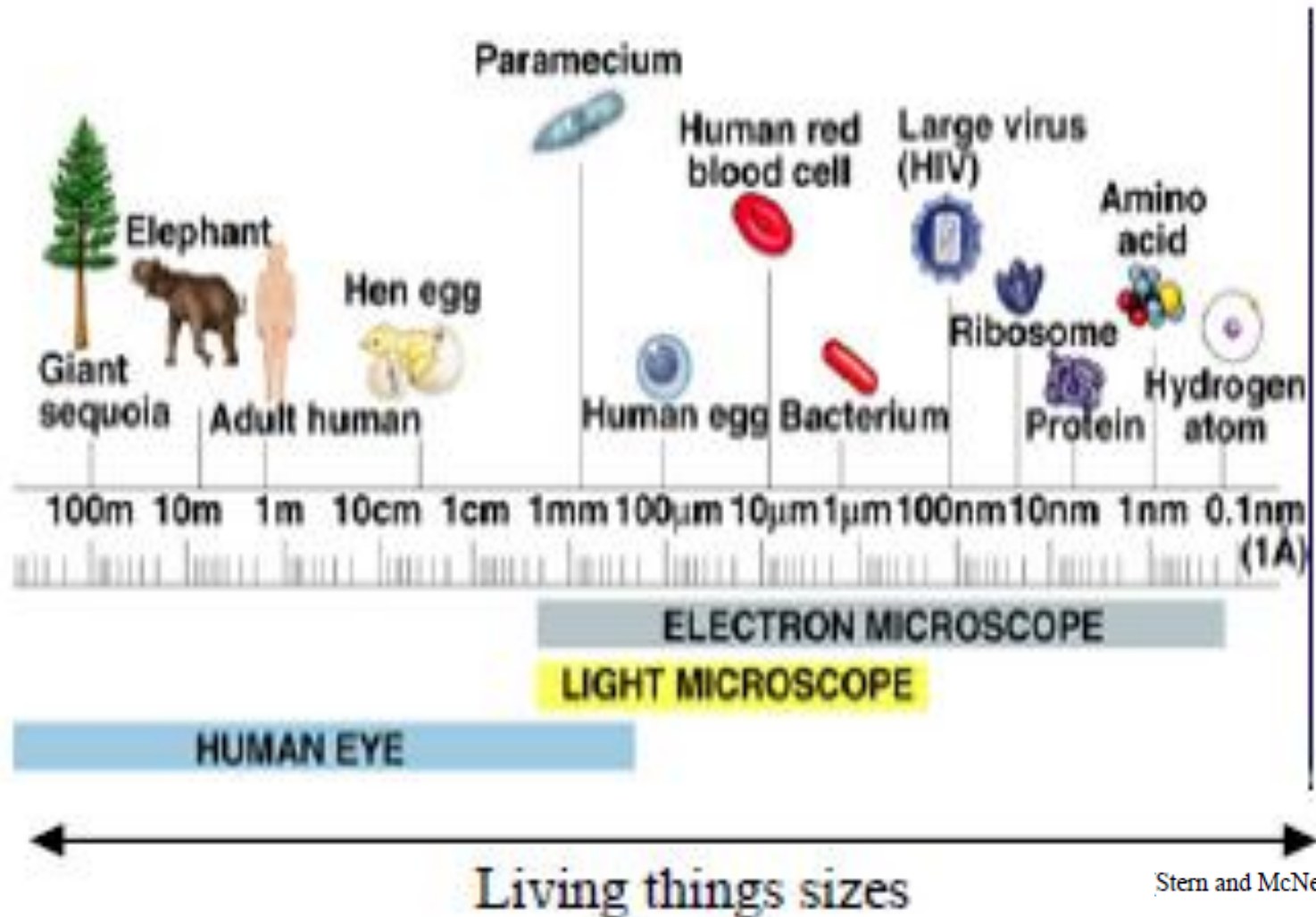


- The four polydisperse modes of traffic-related ambient particulate matter span approximately 4 orders of magnitude from below 1 nm to above 10  $\mu\text{m}$ .
- Nucleation and Aitken mode particles are defined as ultrafine particles ( $< \sim 100$  nm).
- Source-dependent chemical composition is not well controlled and varies considerably.
- In contrast engineered nanoparticles (1-100 nm) have well controlled chemistry and are generally monodispersed.
- The particles  $< 10$  nm have surface properties that are quantum dominated and may represent a separate class of materials.

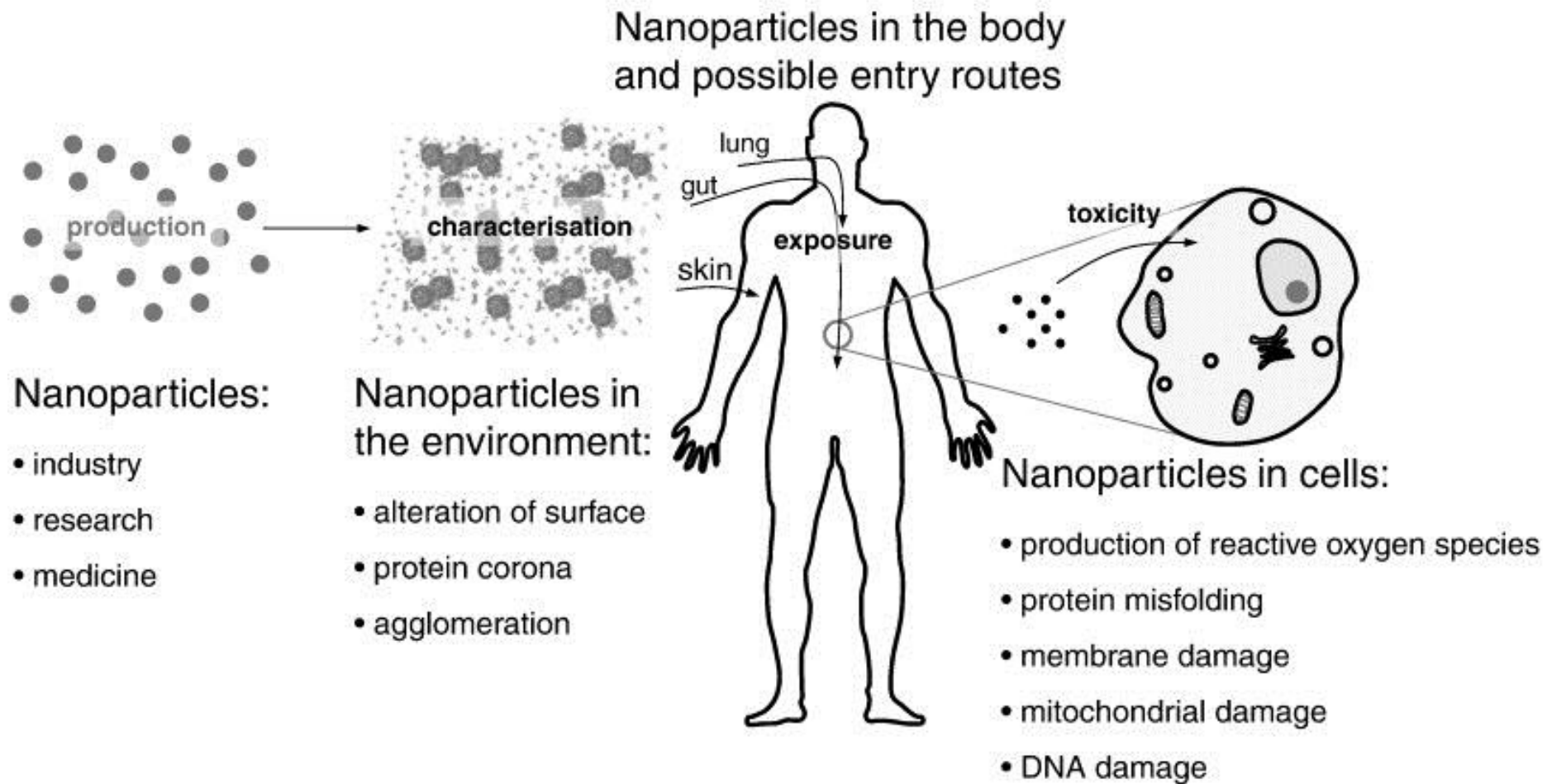
# Particle Scale



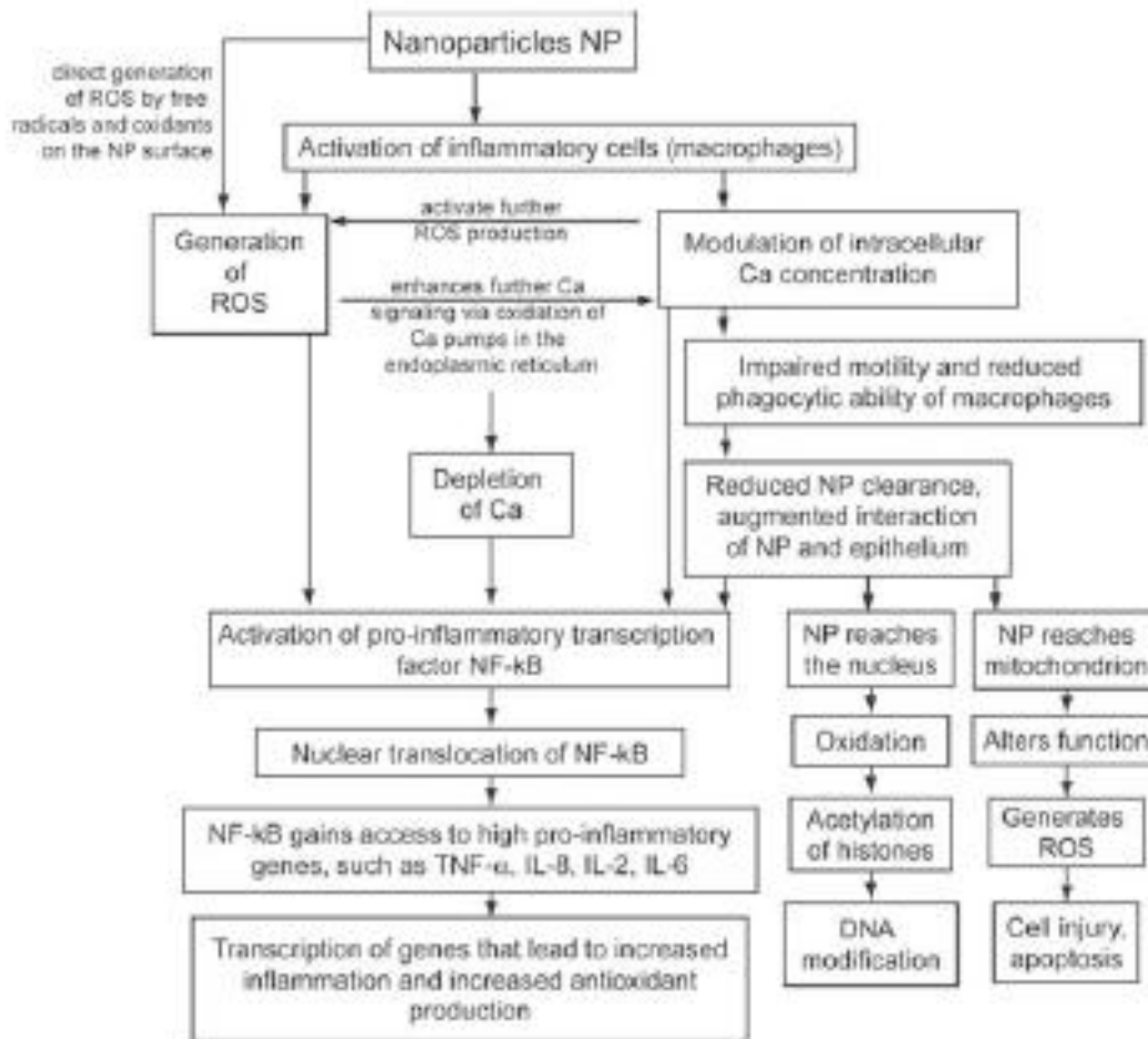
# Where do Nanoparticles fit in with Respect to Biological Systems?



# Nanoparticle characterisation, pathways and toxicological impact

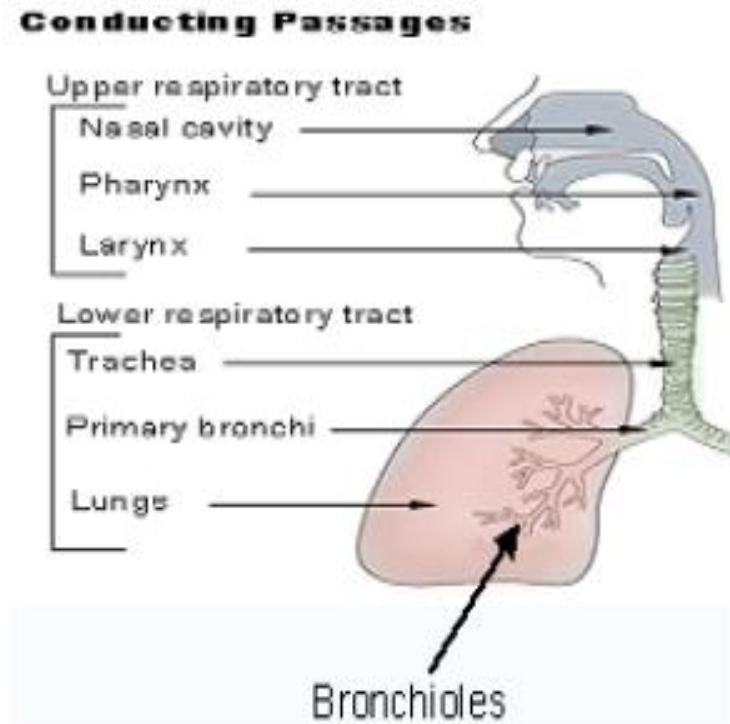


# Schematic Description of Potential Health Outcomes of Nanoparticles, In General



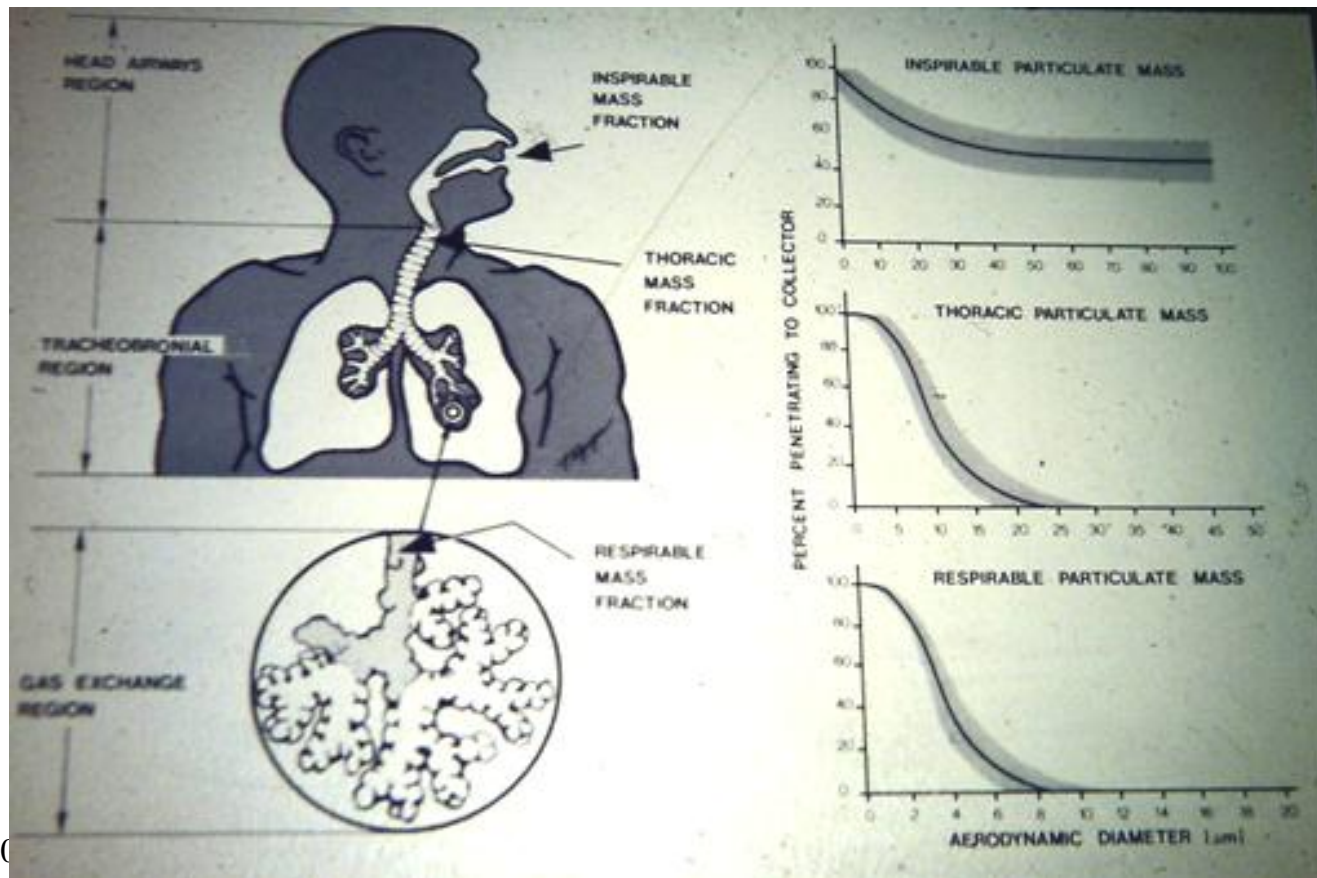
# Understanding How Inhaled Particles can Affect Health Begins With Understanding the Respiratory System

- Particles can deposit in the head and the chest.
- The human lung is a complex, branching structure.
- The structure is also complex at the cellular level .
- This complexity means that different parts of the lung have different sensitivities to particles.

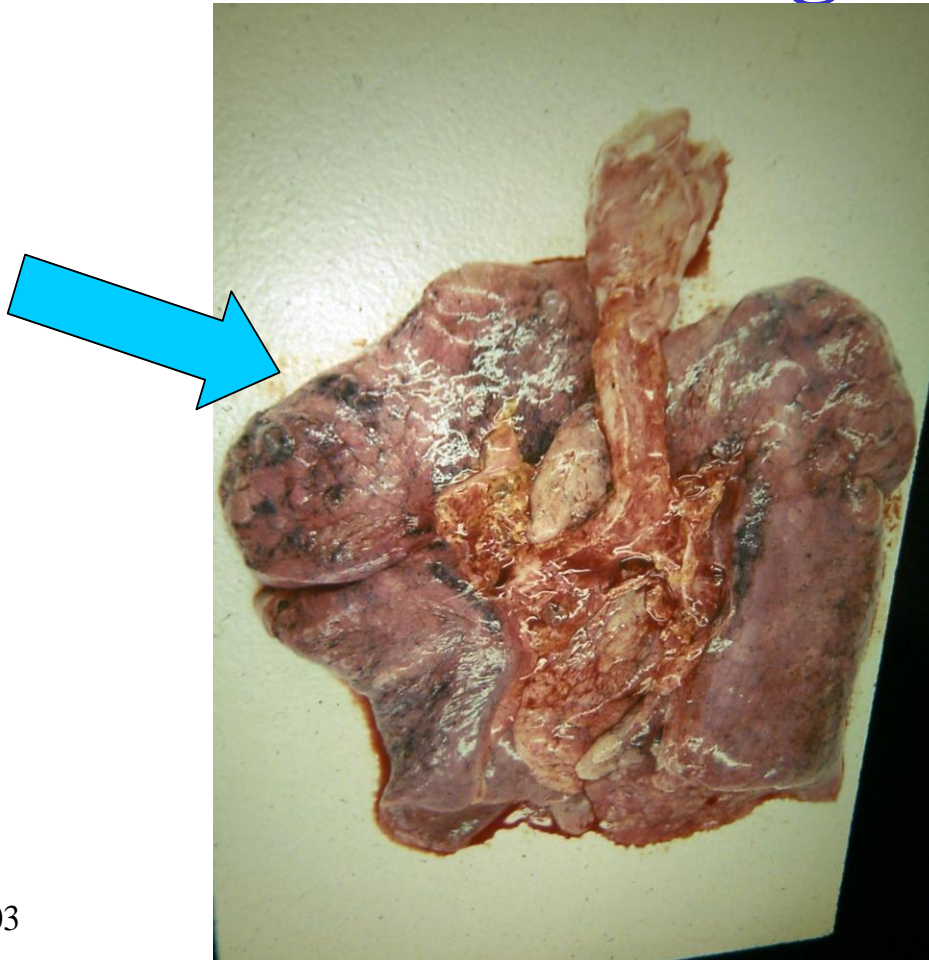




# Particles of Different Size Deposit in Different Places in the Respiratory System . Size Influences Target Sites in the Lung



# **Soluble Particles Clear Quickly But Insoluble Particles Are Retained For Long Periods**



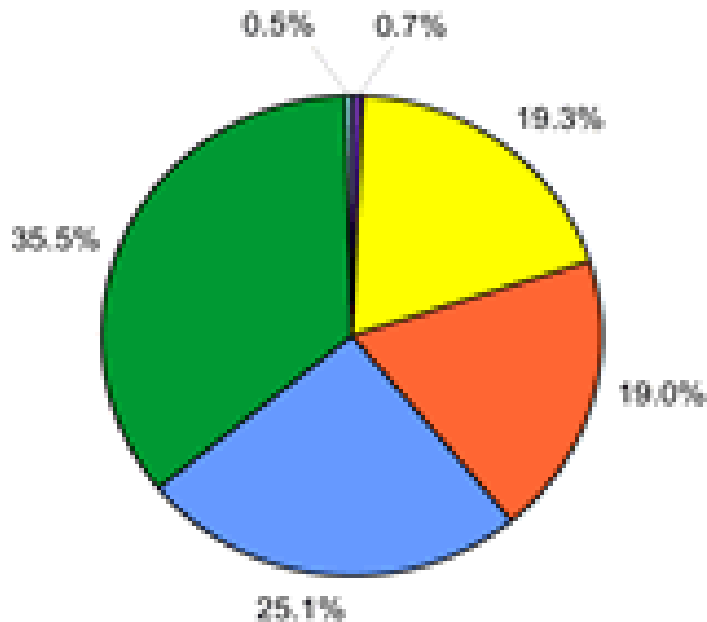
9/11/2003

# What is Black Carbon and how is it Different From Brown Carbon?

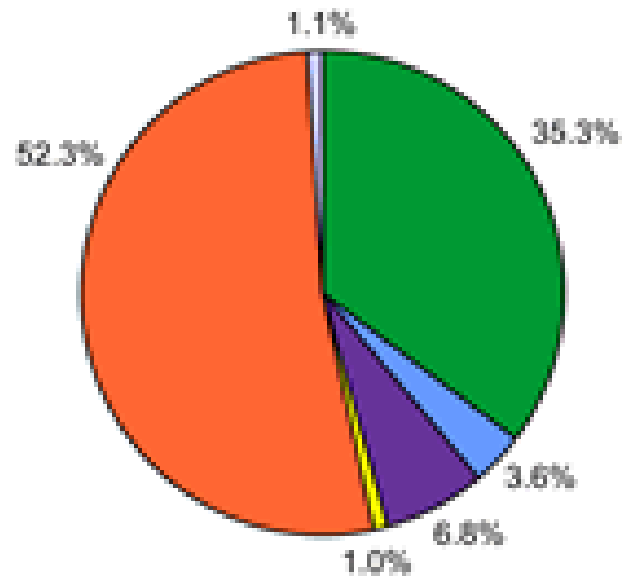
- Black carbon (BC) is the most strongly light-absorbing component of particulate matter (PM), and is formed by the incomplete combustion of fossil fuels, biofuels, and biomass.
- BC is emitted directly into the atmosphere in the form of fine particles ( $PM_{2.5}$ ) and ultrafine particles ( $PM_{0.1}$ ). These are also considered nanoparticles.
- BC is the most effective form of PM, by mass, at absorbing solar energy: per unit of mass in the atmosphere, BC can absorb a million times more energy than carbon dioxide ( $CO_2$ ).
- BC is a major component of “soot”, a complex light-absorbing mixture that comprised of a mixture of Elemental Carbon (EC) and Particulate Organic Carbon (OC).
- Organic carbon aerosols are a significant absorber of solar radiation. The absorbing part of organic aerosols is referred to as “brown” carbon (BrC).

# From Where Does Black Carbon Come?

Global BC Emissions, 2000 (7,600 Gg)



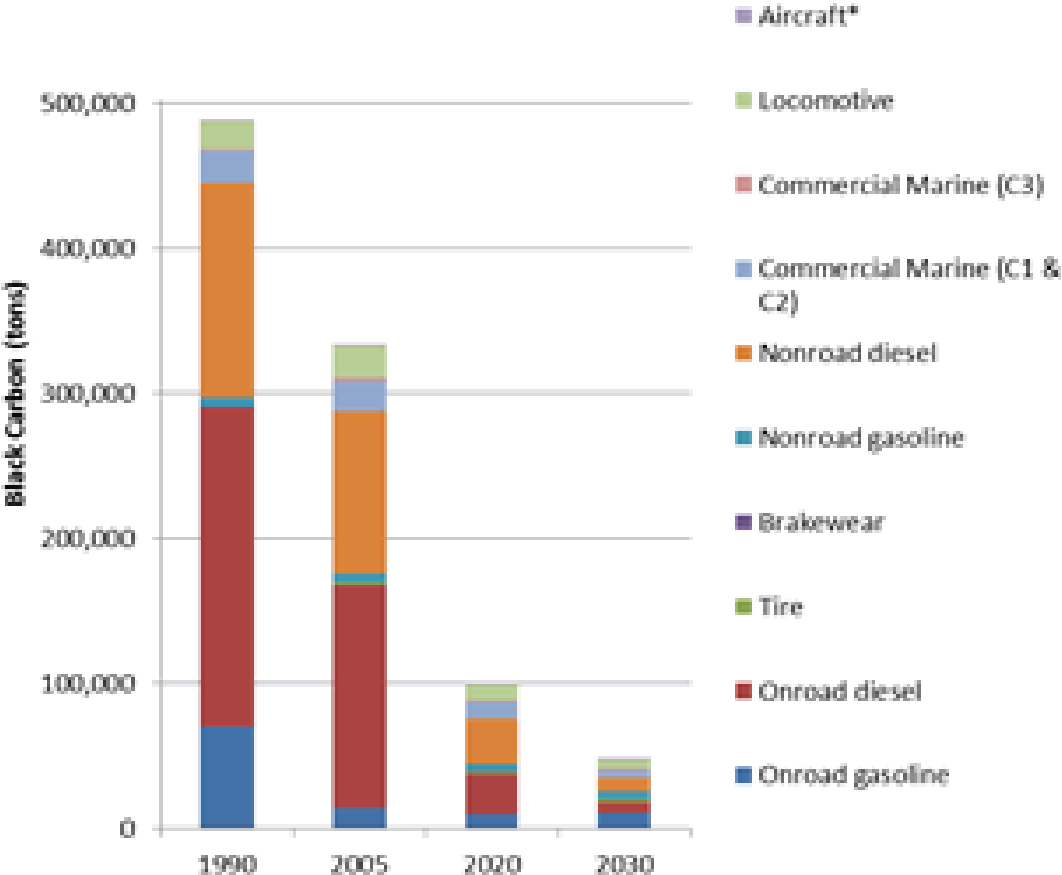
U.S. BC Emissions in 2005 (0.64 Million Tons)



- Open Biomass Burning (Includes Wildfires)
- Transport
- Energy/Power
- Domestic/Residential
- Industry
- Other

# BC Emissions Have Been Trending Down!

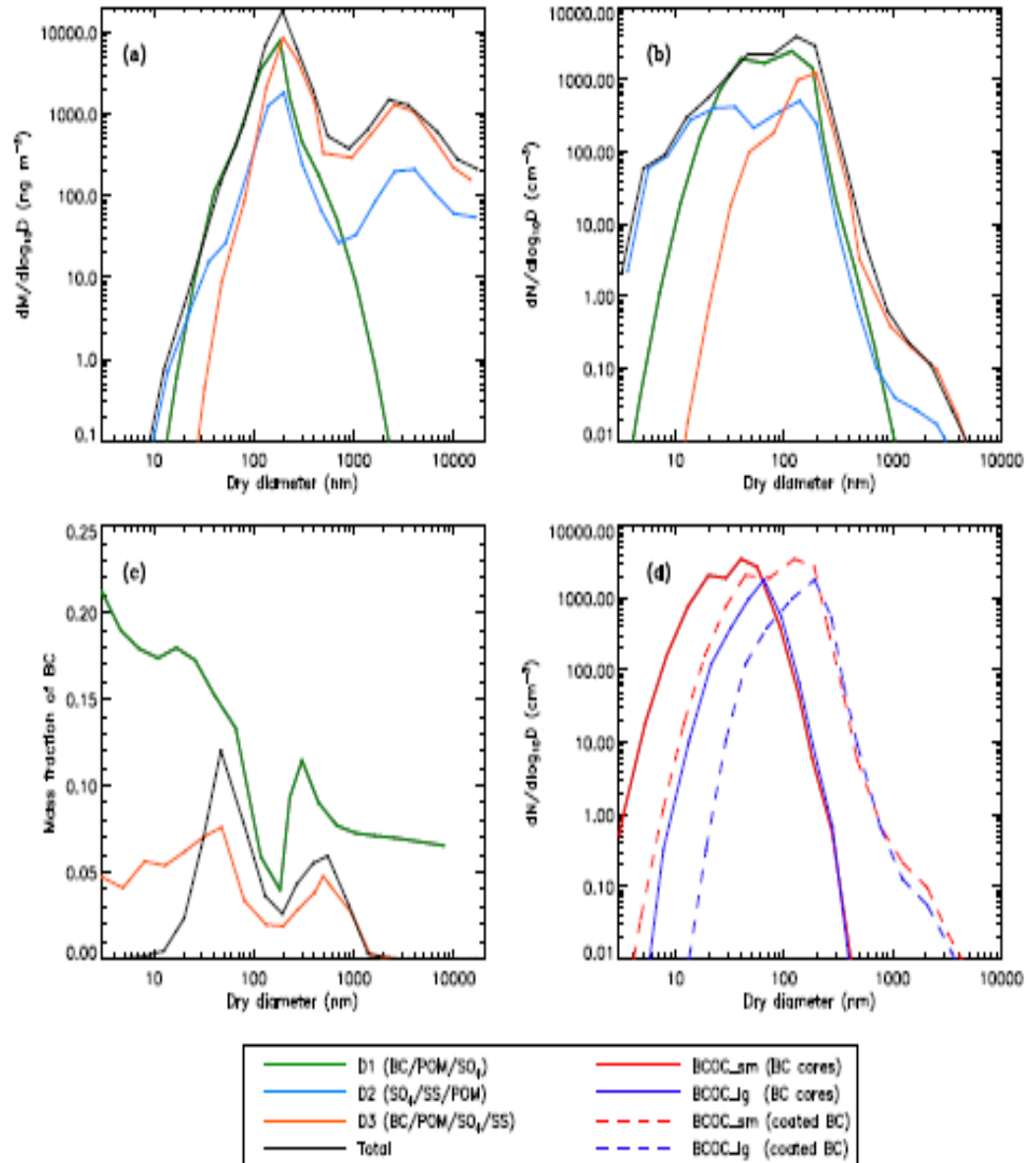
U.S. Mobile Source Emissions Trends, 1990-2030

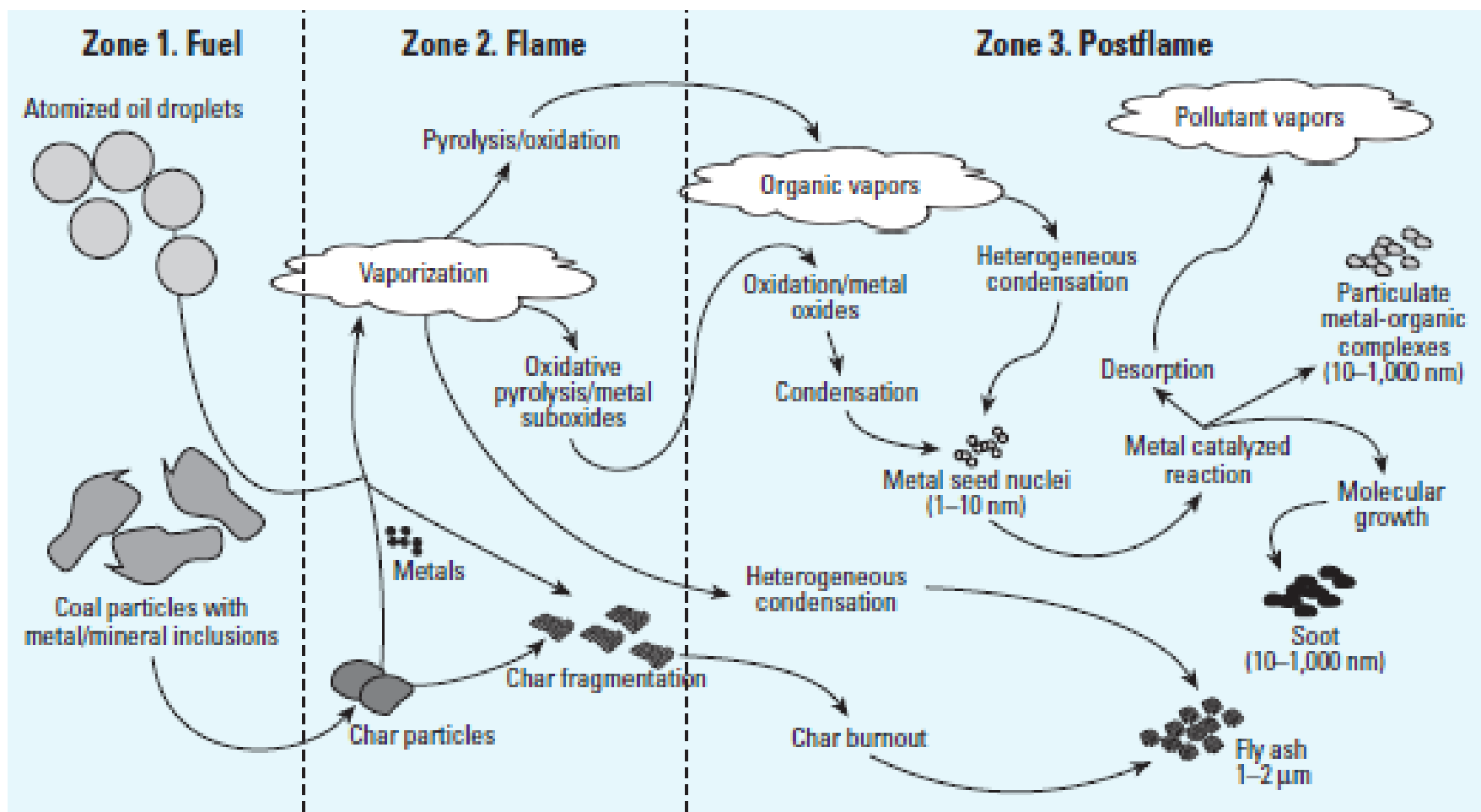


# Black and Brown Carbon are Found in the Nanoparticle Size Range

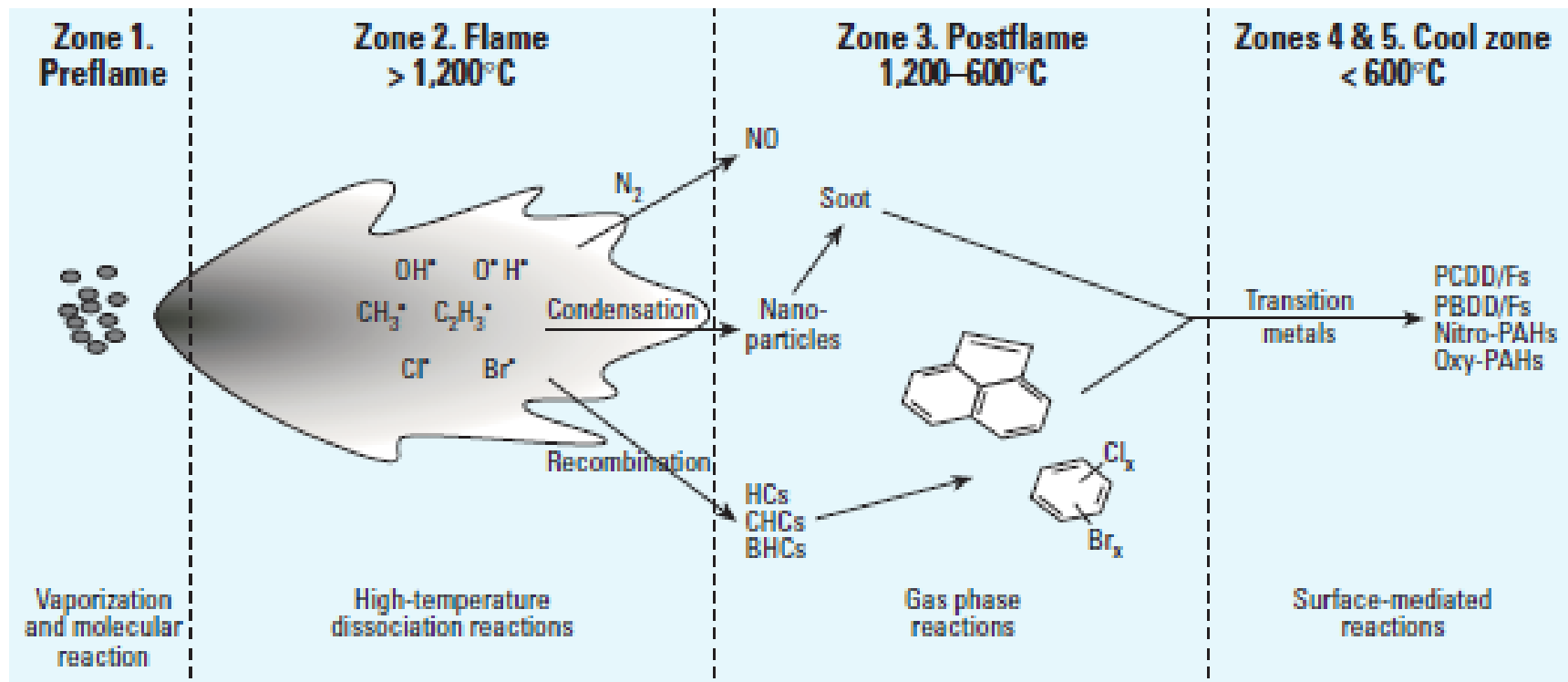
Table 1. Summary of the aerosol distributions and components simulated in GLOMAP for this study. Black carbon (BC), particulate organic matter (POM), sulfate (SO<sub>4</sub>) and sea salt (SS) are included. The aerosol particles in each distribution can grow via condensation of H<sub>2</sub>SO<sub>4</sub> (which enters the SO<sub>4</sub> component) and SOA (which enters the POM component).

Distribution	Components	Sources of particle number
D1	BC, POM, SO <sub>4</sub>	Primary BC/OC particles from fossil fuel, biofuel and biomass burning.
D2	SO <sub>4</sub> , SS, POM	Primary (sub-grid) particulate SO <sub>4</sub> from anthropogenic and volcanic sources, secondary (nucleated) SO <sub>4</sub> particles, and primary SS particles.
D3	BC, POM, SO <sub>4</sub> , SS	Mixed component particles from coagulation between distributions D1 and D2.



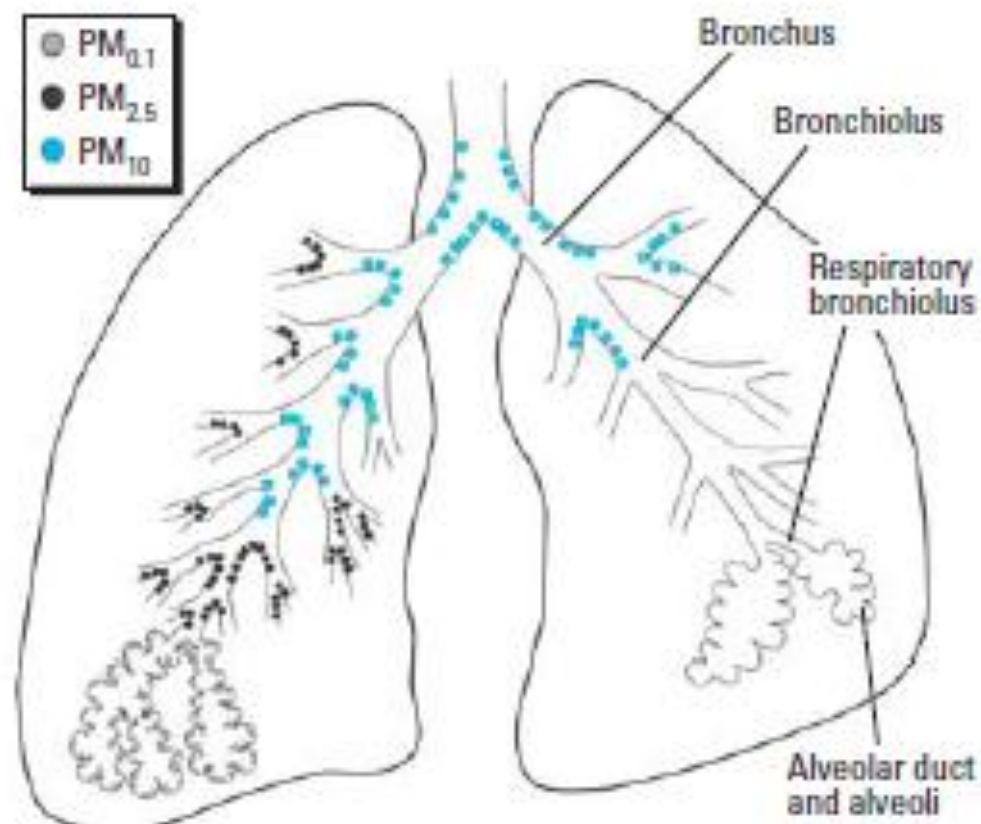


**Figure 2.** Nanoparticle formation/growth and mediation of pollutant-forming reactions in combustion systems. The combustor reaction zones described in Figure 1 effect particle formation as well as gas-phase pollutant formation. Metals and other refractory compounds are vaporized in the flame zone. They can recondense as cluster or seed nuclei in the postflame zone, where they catalyze further particle growth and pollutant formation in the cool zones.

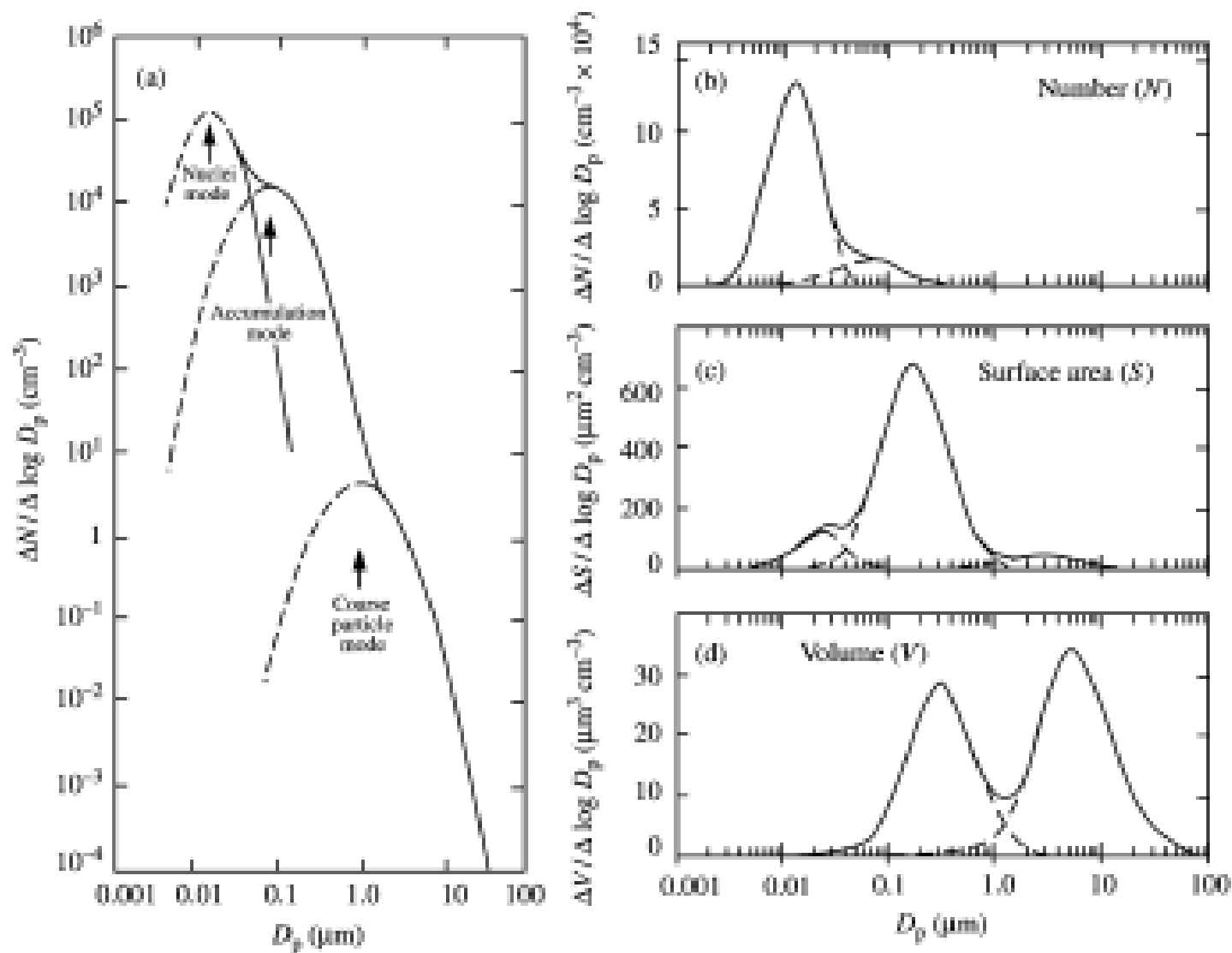


**Figure 1.** Combustor reaction zones. Zone 1, preflame, fuel zone; zone 2, high-temperature, flame zone; zone 3, postflame, thermal zone; zone 4, gas-quench, cool zone; zone 5, surface-catalysis, cool zone. PBDD/Fs, polybrominated dibenzo-*p*-dioxins and dibenzofurans. Reaction products from upstream zones pass through downstream zones and undergo chemical modifications, resulting in formation of new pollutants. Zone 2 controls formation of many “traditional” pollutants (e.g., carbon monoxide, sulfur oxides, and nitrogen oxides). Zones 3 and 4 control formation of gas-phase organic pollutants. Zone 5 is a major source of PCDD/Fs and is increasingly recognized as a source of other pollutants previously thought to originate in zones 1–4.





**Figure 3.** Distribution of PM in the airways. PM  $\geq 10$   $\mu\text{m}$  in diameter enter the nose and mouth. The thoracic fraction,  $PM_{10}$ , passes the larynx and penetrates the trachea and bronchial regions of the lung, distributing mainly at pulmonary bifurcations. The respirable fraction,  $PM_{2.5}$ , and ultrafine PM,  $PM_{0.1}$ , enter the nonciliated alveolar regions and deposit deep within the lungs.



## Tropospheric Aerosols

P. R. Buseck  
 Arizona State University, Tempe, AZ, USA  
 and  
 S. E. Schwartz  
 Brookhaven National Laboratory, Upton, NY, USA

**Figure 6** Several views of the size distribution of a hypothetical aerosol consisting of three modes: denoted nuclei, accumulation, and coarse. Panel (a) is a log-log plot of number distribution of the three modes and their sum as a function of particle diameter,  $D_p$ . Panels (b)–(d) are semi-log plots of number ( $N$ ), surface area ( $S$ ), and volume ( $V$ ) distributions, respectively (Whitby, 1978) (reproduced by permission of Elsevier from *Atmos. Environ.* 1978, 12, 135–159).

## Tropospheric Aerosols

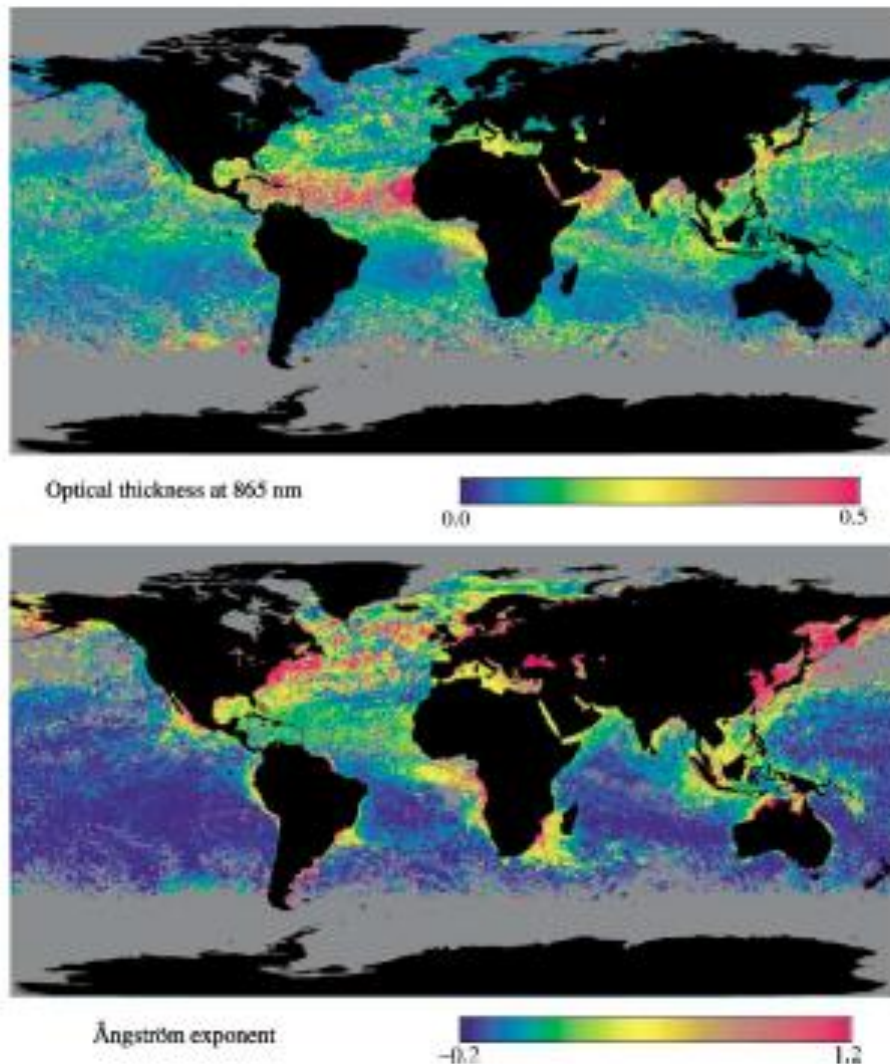
P. R. Buseck

Arizona State University, Tempe, AZ, USA

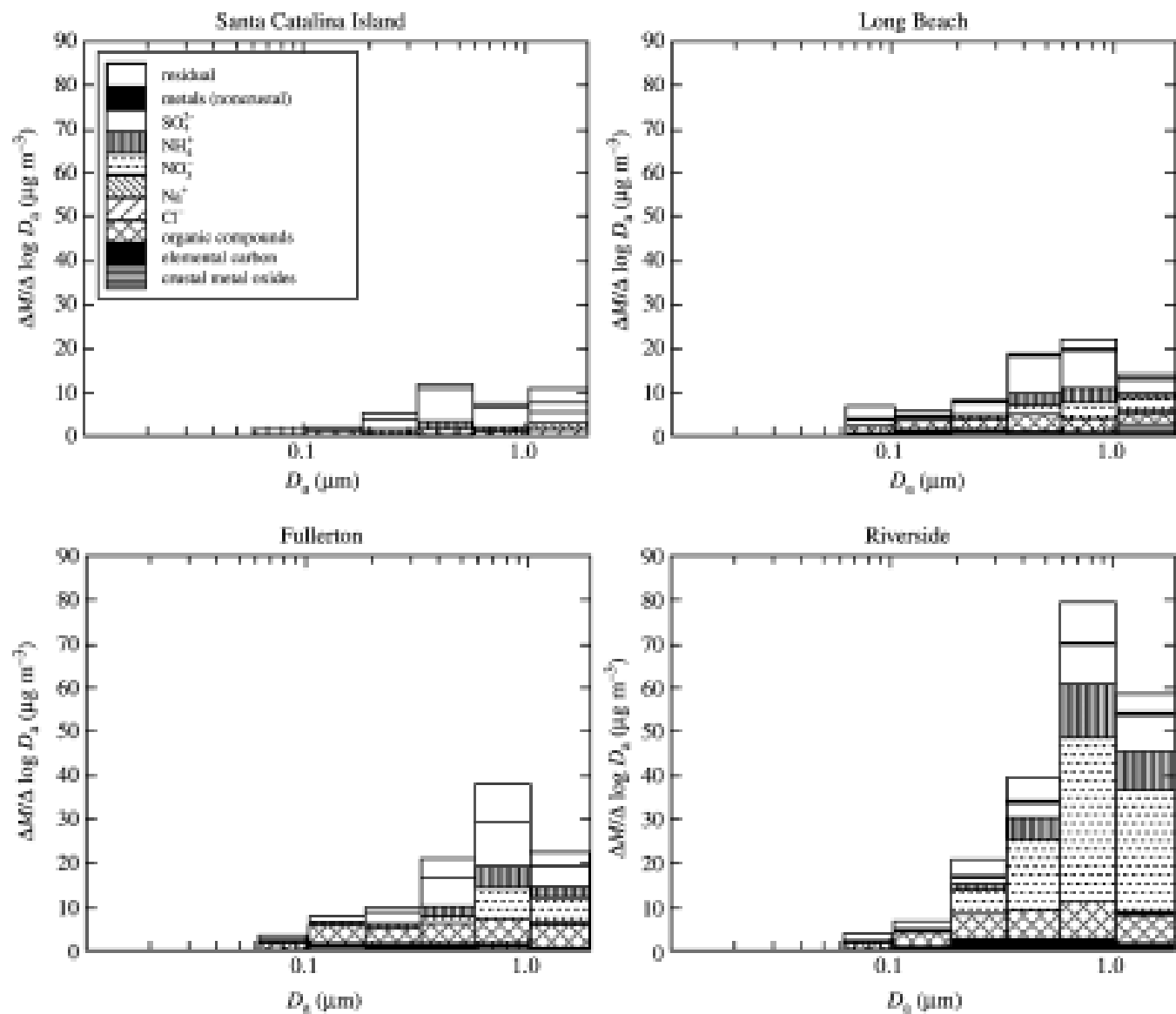
and

S. E. Schwartz

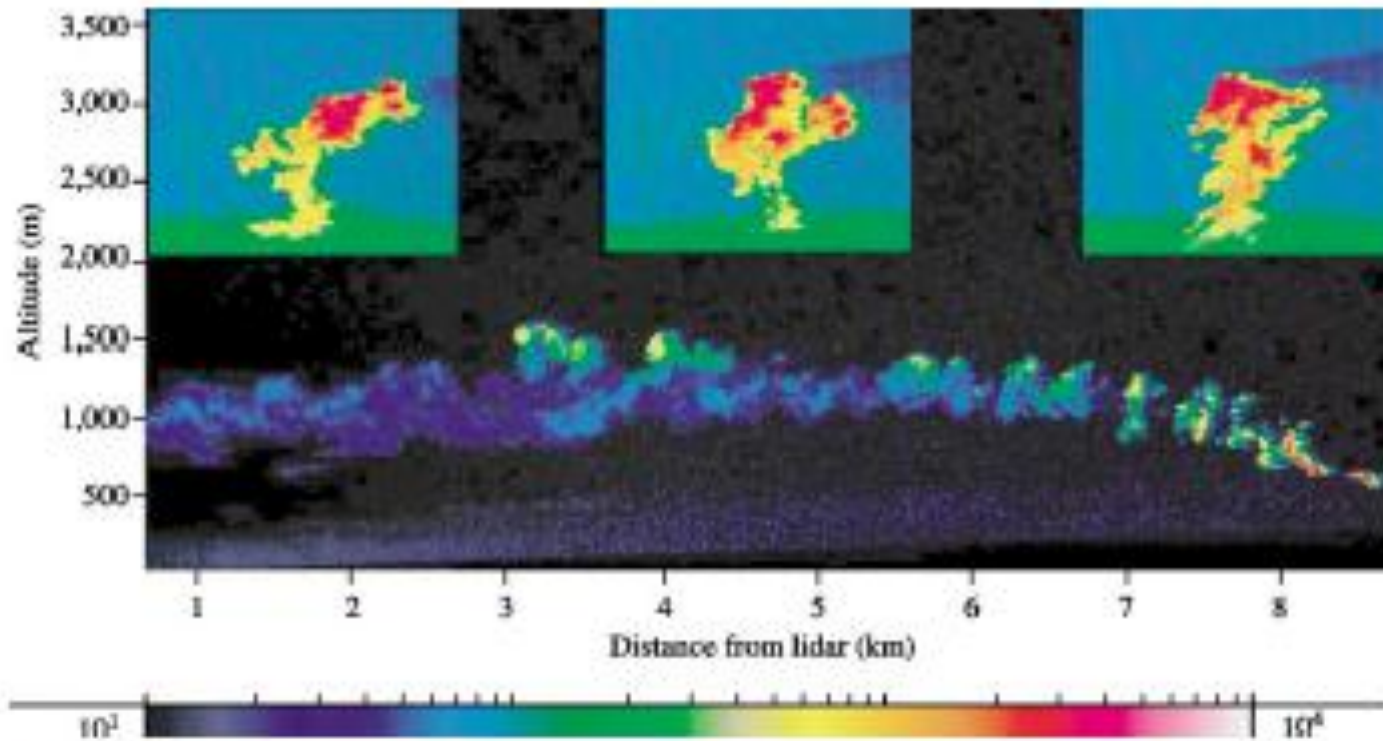
Brookhaven National Laboratory, Upton, NY, USA



**Figure 18** Global distribution of AOT  $\tau$  at 865 nm (upper panel) and dependence on wavelength  $\lambda$  as the Ångström exponent,  $\alpha = -d \ln \tau / d \ln \lambda$  (lower panel) for June 1997. The distributions were derived from radiance measurements at 18-km resolution by the POLDER (POLARization and Directionality of the Earth's Reflectance) radiometer aboard the ADEOS (ADvanced Earth Observing Satellite) platform. Retrieval is limited to the atmosphere above water surfaces. Courtesy of Laboratoire d'Optique Atmosphérique, Lille, France; Laboratoire des Sciences du Climat et de l'Environnement, Gif sur Yvette, France; Centre National d'études Spatiales, Toulouse, France; and National Space Development Agency, Japan. For further information see <http://earth-sciences.cnes.fr:8060/polder/Mission.html> and Deuzé *et al.* (1999).



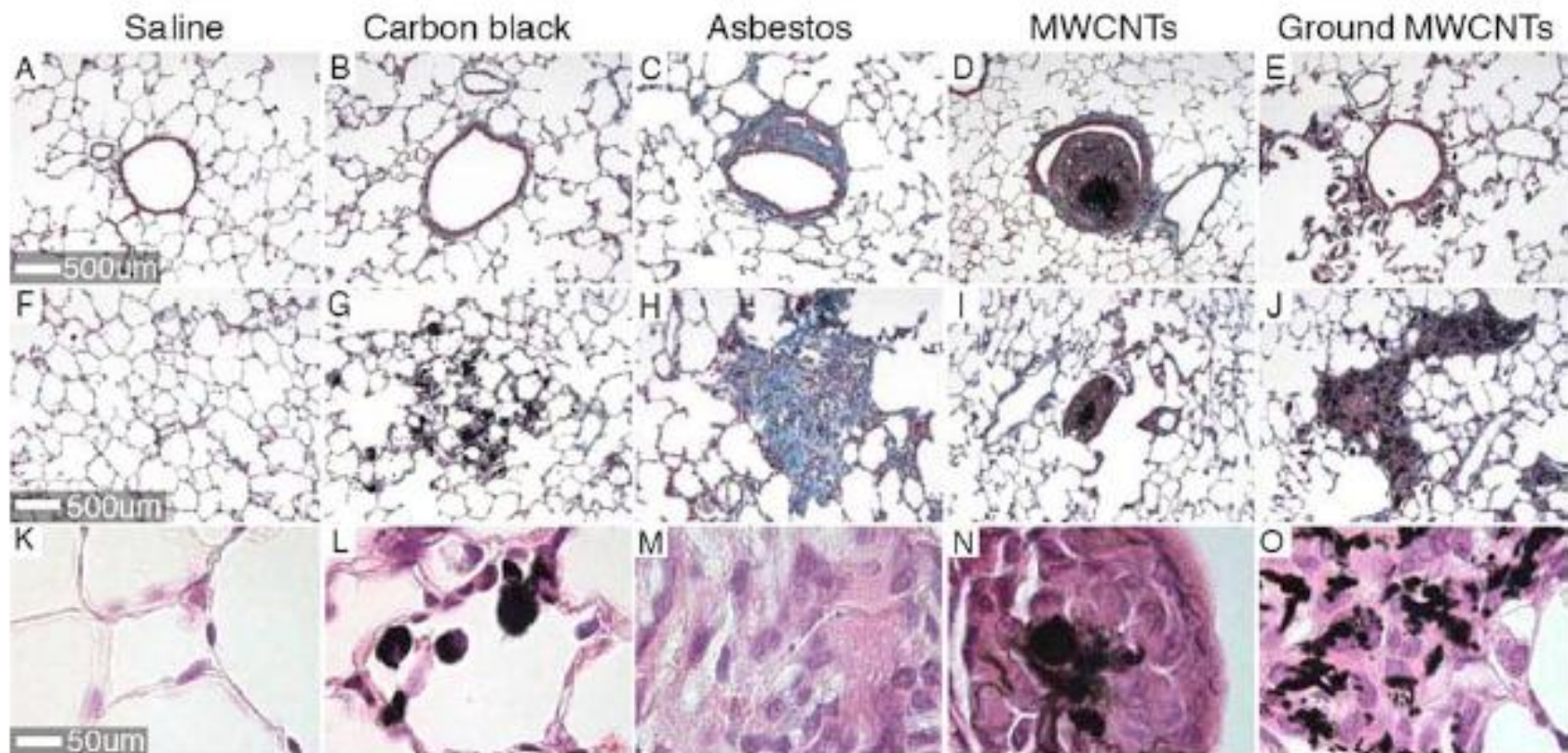
**Figure 10** Size-dependent composition of aerosol particles for several sites in the vicinity of Los Angeles, California over several days in September and October 1996. Particles were sampled with a cascade impactor preceded by a cyclone separator with a cut size of  $1.8 \mu\text{m}$  aerodynamic diameter (Hughes *et al.*, 1999), (reproduced by permission of American Chemical Society from *Environ. Sci. Technol.* 1999, 33, 3506–3515).



**Figure 20** Lidar images of an aerosol-rich plume emitted from a power plant. The plume, viewed lengthwise from the ground, is above the PBL at an altitude of  $\sim 0.3$  km. The inserts are enlarged cross-sections of a similar plume, taken at 1 min intervals. The shapes of such sections change continuously with both position along the length of the plume and with time. Nanticoke power plant, Ontario, Canada. The lengthwise and cross-section images were taken on January 22 and 19, 2000, respectively at 1,064 nm, with scan speeds adjusted depending on distance from source and proximity of mobile lab to produce a full-scan image in less than 1 min. The images were obtained by and are courtesy of K. Strawbridge, Meteorological Service of Canada.

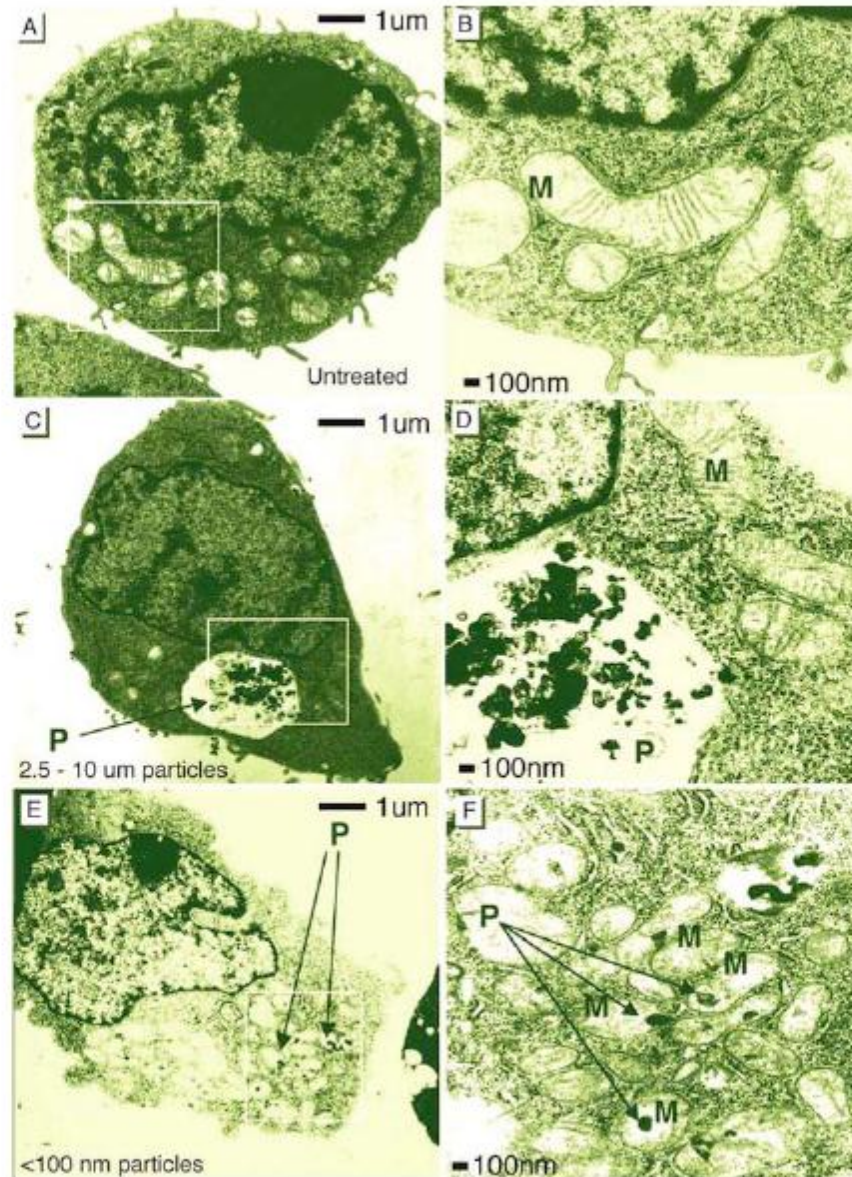
## Tropospheric Aerosols

P. R. Buseck  
 Arizona State University, Tempe, AZ, USA  
 and  
 S. E. Schwartz  
 Brookhaven National Laboratory, Upton, NY, USA



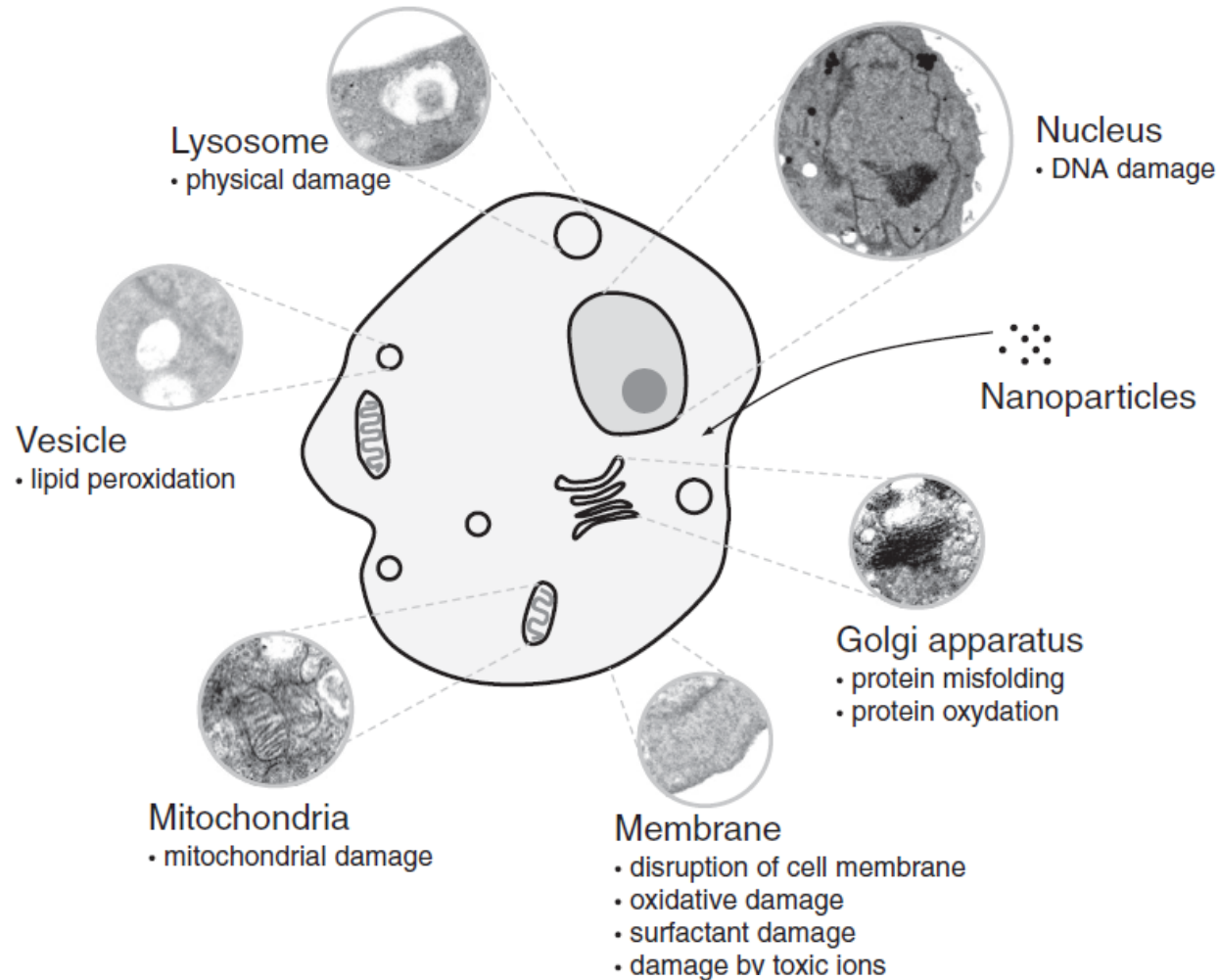
*Figure 27. Rat lung lesions induced by nanoparticles of: (B,G,L) carbon black, (C,H,M) asbestos, (D,I,N) multiwall carbon nanotubes, and (F,J,O) grounded nanotubes compared to saline solution (A,F,K) [159]. Reproduced with permission from Elsevier.*

The adverse effect of inhaled nanoparticles on the lungs depends on the lung burden (determined by the rate of particle deposition and clearance) and on the residence time of the nanoparticles in the lung [39], [203]. For example, carbon nanotubes are not eliminated from the lungs or very slowly eliminated (81% found in rat lungs after 60 days) [159]. The persistent presence within the alveoli of inhaled particles (Figure 27), especially those with mutagenic potential, increases the risk of lung cancer [39].



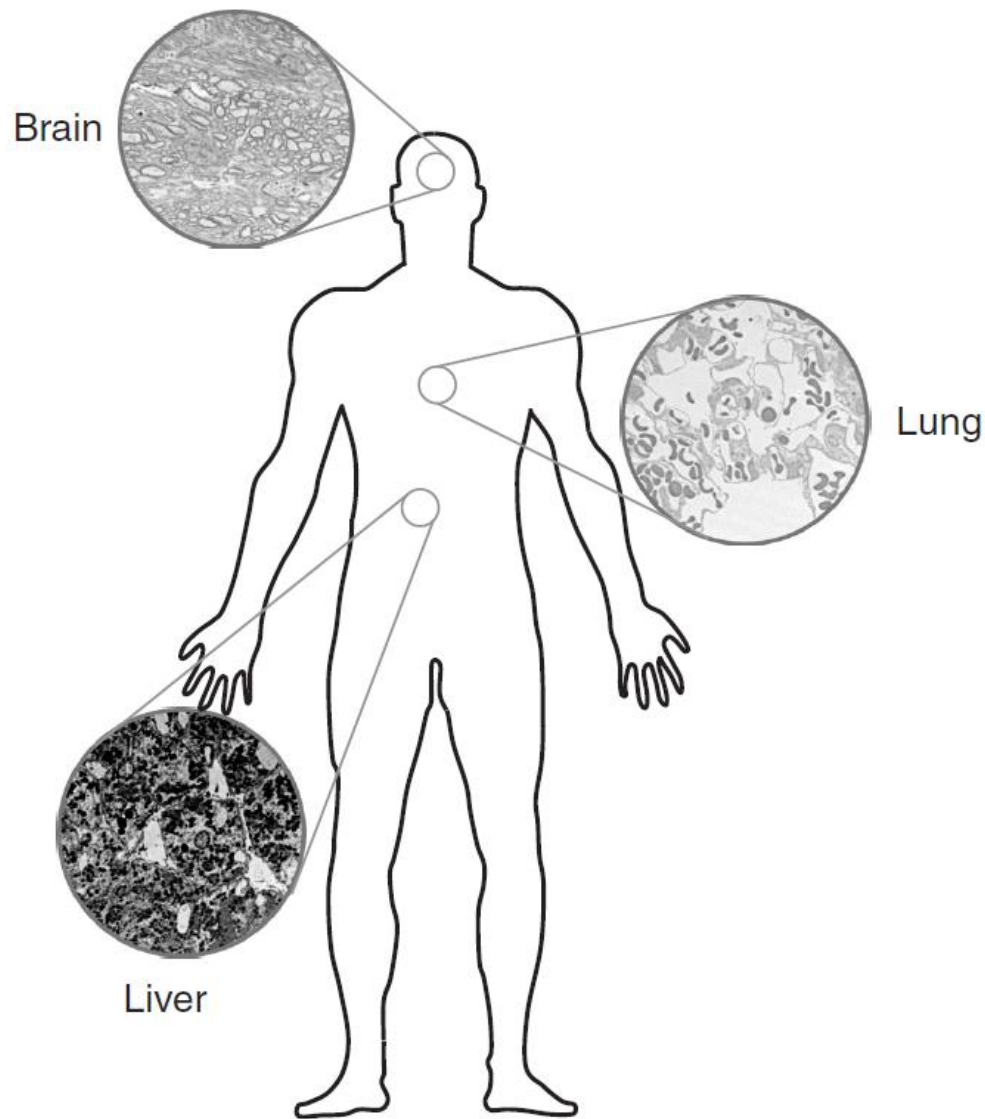
*Figure 28. TEM images showing effects of environmental particles size (P) on murine macrophage cells RAW 264.7 treated with various size particles: (a,b) untreated, (c,d) 2.5 - 10  $\mu\text{m}$  size particles, (e,f) particles smaller than 100 nm. M denotes mitochondria [57]. Reproduced with permission from Environmental Health Perspectives.*

## Nanoparticle interaction with cells: intracellular targets and nanotoxicological mechanisms.

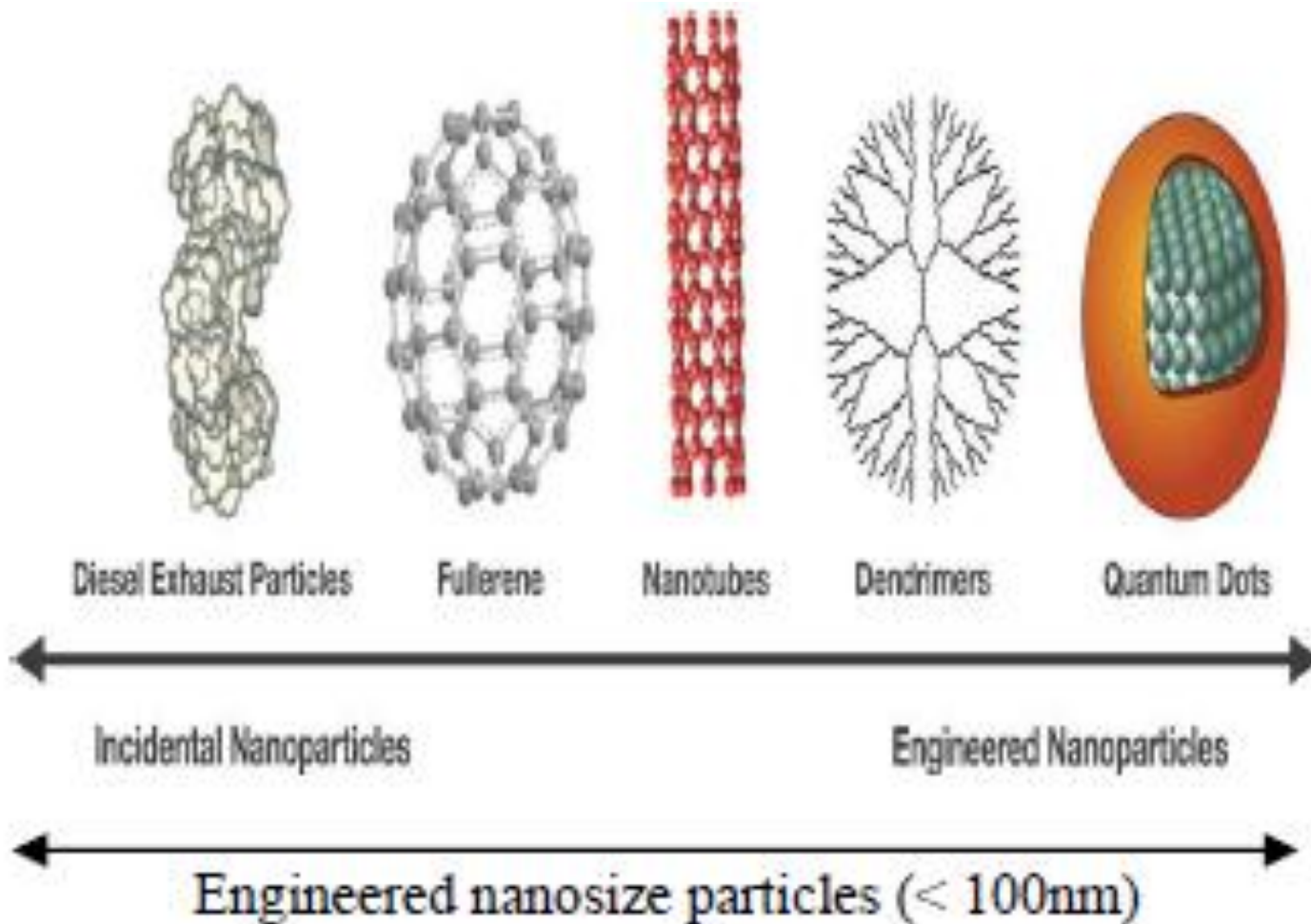




Nanoparticle entry route into the body via the lung, particle accumulation in the liver and the most vulnerable site: the brain.



# Typical Ambient Black Carbon Nanoparticles vs. Engineered Particles



# Do Ambient Nanoparticles Play a Role in Cardiovascular Disease?

- An increase in air pollutants leads to increased mortality and hospital admissions because of cardiovascular diseases (Analitis A. et al. 2006, Zanobetti et al. 2003, Dominici et al. 2006, Peel et al. 2007)
- Exposure to elevated levels of particulate matter (PM) in ambient air leads to an increased heart rate (HR) and a decreased heart rate variability (HRV) in elderly patients (Dubowsky Adar S. et al. 2007, Luttmann-Gibson et al. 2006)
- Individuals in the >65 year-old age bracket are more susceptible to air pollution-associated heart-related morbidity and mortality
- Black and Brown Carbon are important constituents of ambient nanoparticles!

# Recent Findings and Implications of Air Quality-Related Health Research at UC Irvine

- Nearly 50% of deaths are associated with heart disease.
- Ultrafine PM (UFP) is more effective than Fine PM in promoting atherosclerosis.
- Biomarkers of heart disease are associated with organic (OC) and elemental carbon (EC) components of UFP.
- UFP may be important because large surface area may act as a “carrier” that brings chemicals into areas that they couldn’t ordinarily reach.

## Epidemiology

- Delfino – Cardiovascular effects of UFP, association of biomarkers with adverse effects
- Wu - Land use regression for traffic related adverse responses
- Edwards - Exposure and risk assessments.

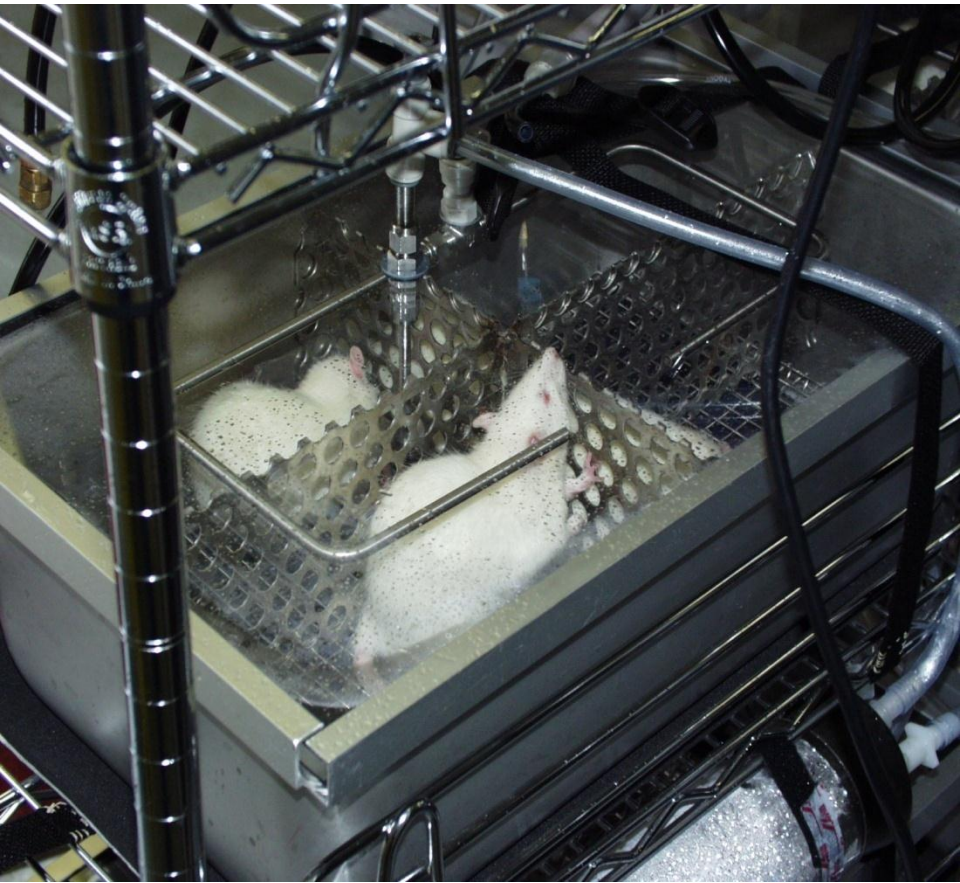
- APHEL – Near road exposures promote airway allergies; PM exposure accelerates atherosclerosis.

- AirUCI – ongoing characterization of ambient aerosols.
- UCLA - in vitro toxicology assays.
- USC - Characterization of ambient PM organics.

# What do we know about nanoparticles and health?

- Particles or Particulate Matter (PM):
  - Particles are associated with increased heart-related deaths during air pollution episodes.
  - The strongest associations with human heart-related illness and death are with PM.
  - Toxicology studies show that PM<sub>2.5</sub> accelerates the development of atherosclerosis.
  - Exposures to urban ambient nanoparticles have greater effects on the heart than do PM<sub>2.5</sub> particles.
- We can use toxicology studies to examine why this is so!

Rats or Mice Can Be Exposed to Purified Air or CAPs in Sealed Chambers



The Sealed Chambers Can Be Placed Onto Racks to Facilitate Transport

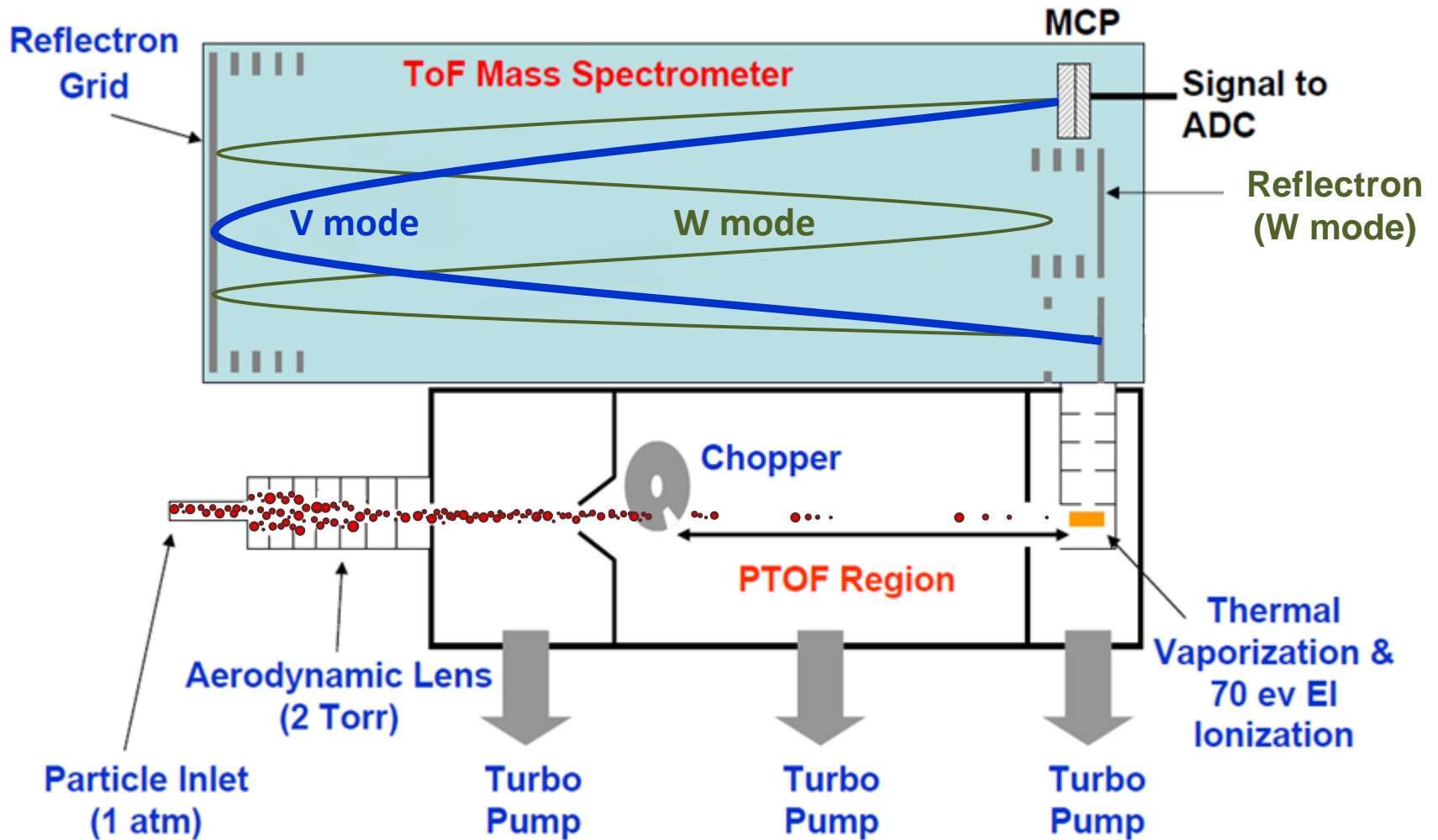


ECG and Blood Pressure Telemetry Devices can be Implanted to provide physiology data before, during and after exposures.

# Objectives

- Use an Aerosol Mass Spectrometer (AMS) and a Scanning Mobility Particle Sizer (SMPS) to examine size and composition of ambient and concentrated particles.
- Use a thermal denuder to strip semi-volatile components from quasi-Ultrafine CAPs ( $d_p < 180$  nm).
  - What is removed?
  - How does the removal alter toxicity?

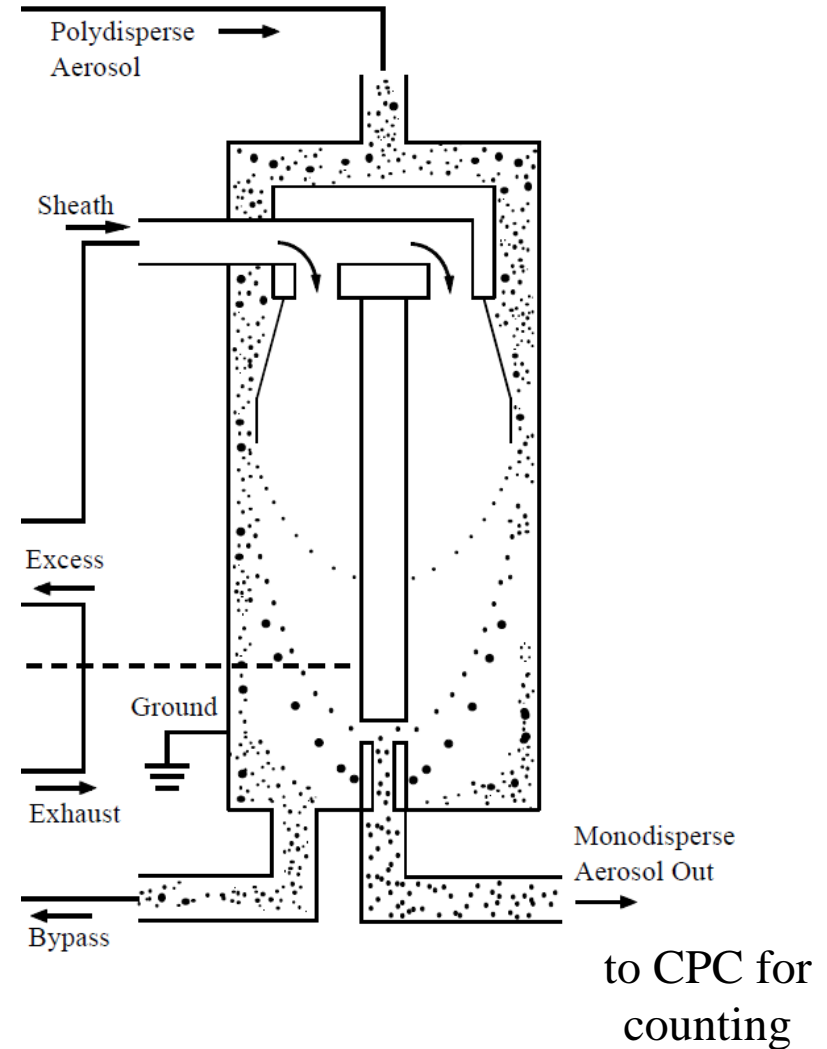
- AMS provides real time high resolution mass spectra of particles as well as particle size distributions (aerodynamic diameter).



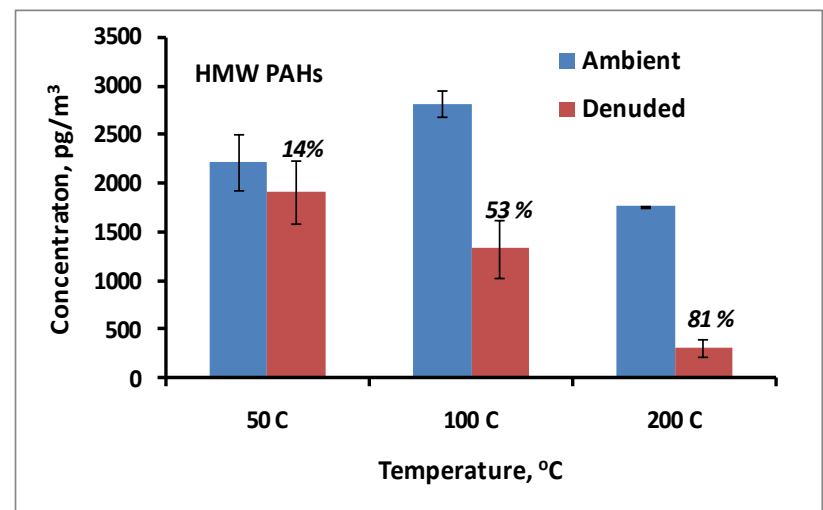
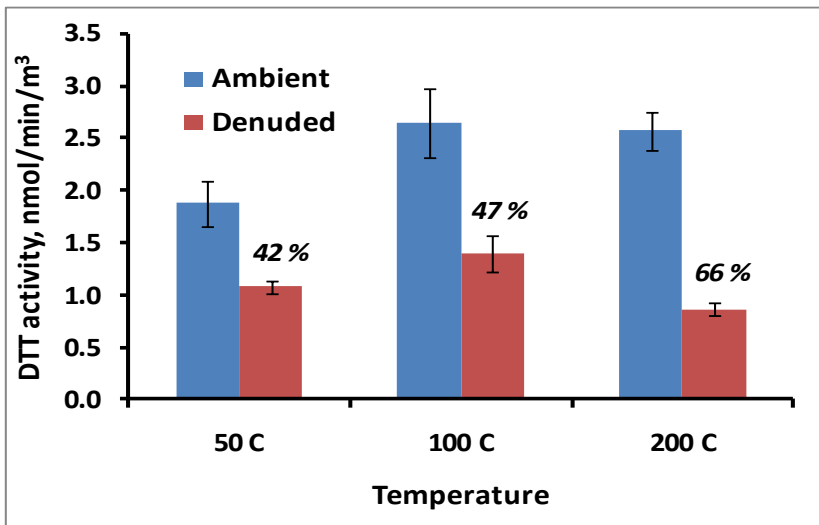
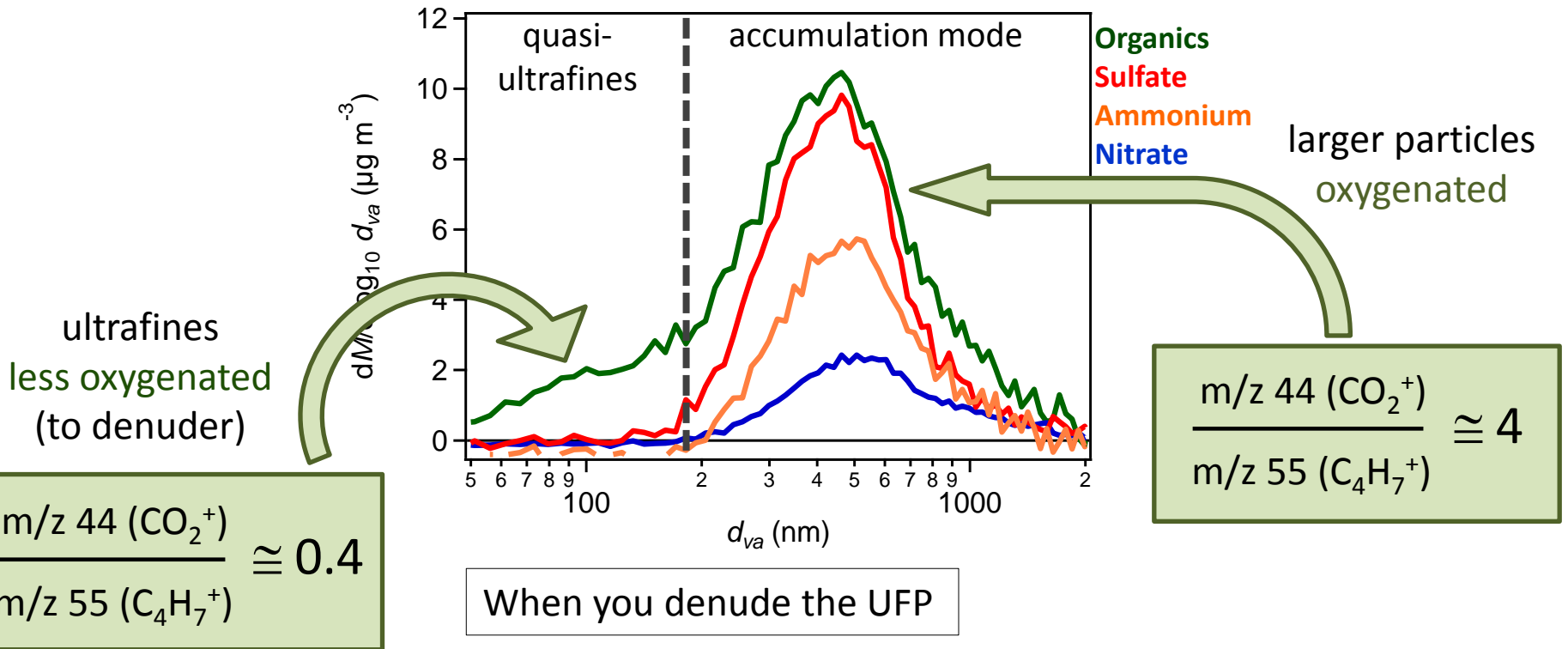


# Scanning Mobility Particle Size Spectrometer (SMPS)

- SMPS measures electrical mobility diameter of polydisperse aerosol samples.
- Size distributions and particle concentrations were measured before and after the particle concentrator.
- AMS data collected of ambient air and particles concentrated by particle concentrator.

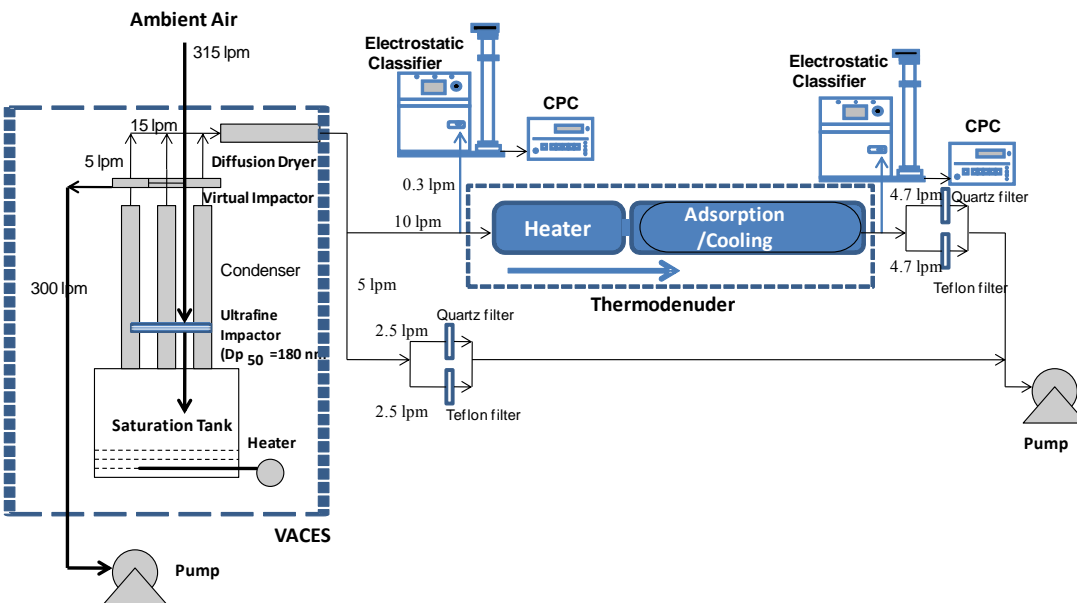


# Health-related characteristics of Ultrafine PM

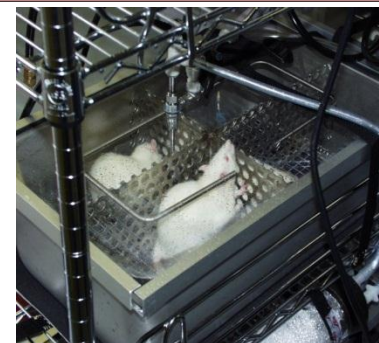


# Testing a Specific Mechanism by which PM Exposure Exacerbates Heart Disease

- Human biomarker study (Delfino) indicated importance of UFP organic carbon (OC) constituents related to coronary artery disease.
- We had previously shown that UFP accelerates atherosclerosis in mice.
- We had also shown that PM is less reactive, in vitro, when we remove the organic constituents from UFP using a denuder (which works analogously to modern diesel afterburner emission controls).
- So we tested the hypothesis that removal of the OC from UFP would block the acceleration of atherosclerosis.

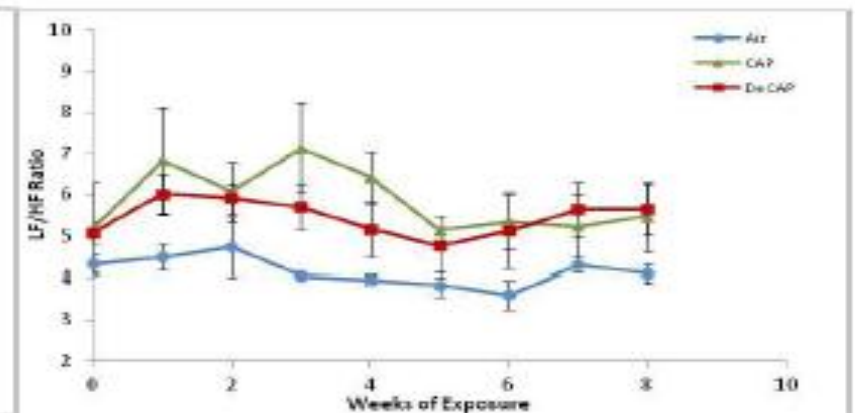
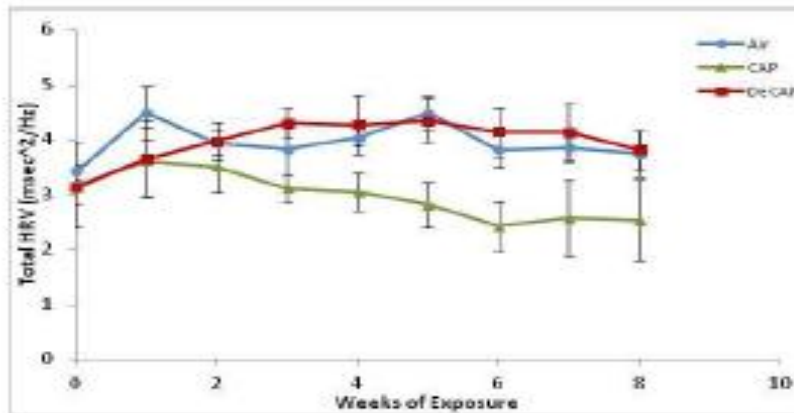
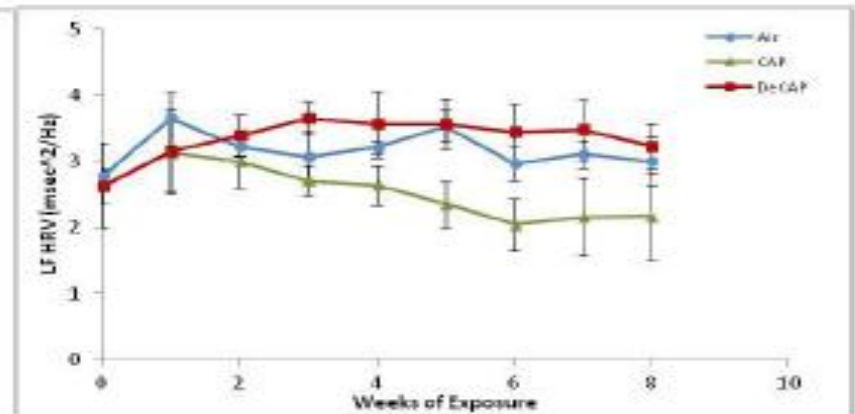
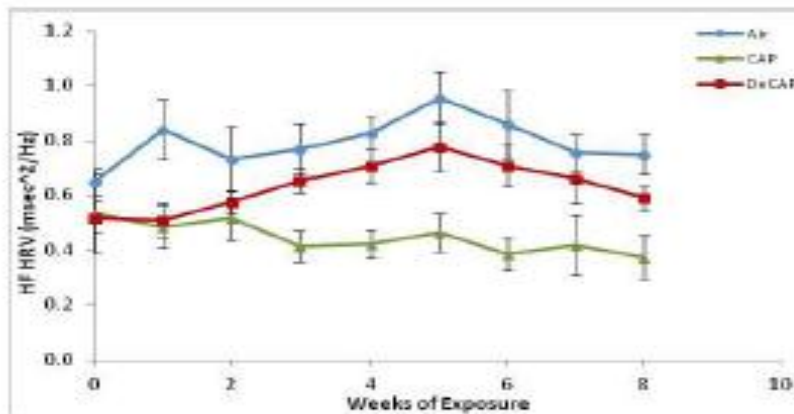


1. We exposed mice in LA to air, denuded and undenuded PM.
2. We examined serum biomarkers and arteries

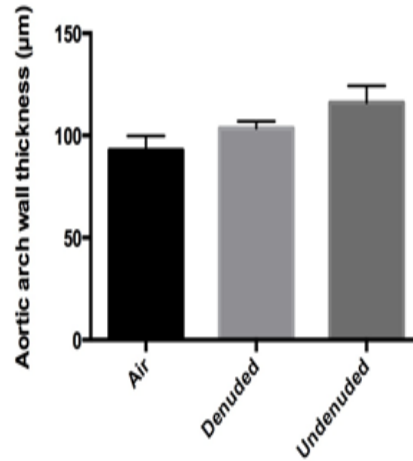
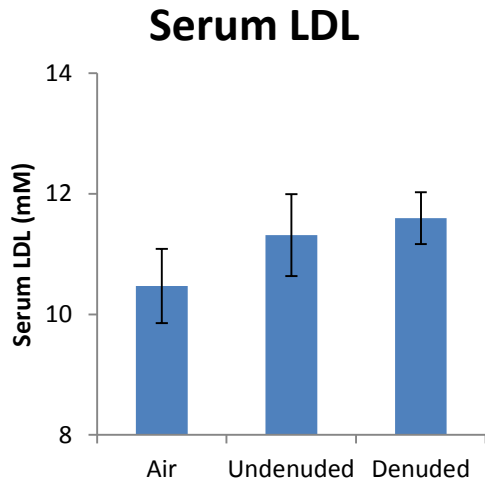


# Ambient PM Exposure Causes Reduced Heart Rate Variability – Removing the Organic Constituents Blocks The Effect

## Heart Rate Variability

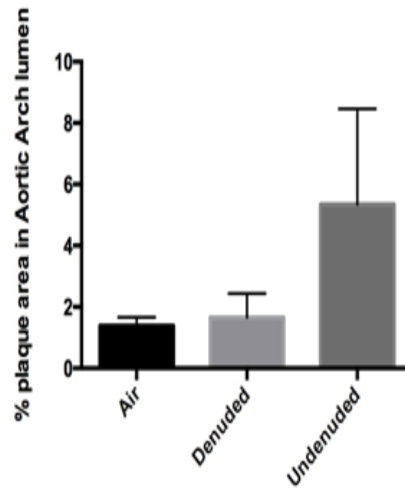
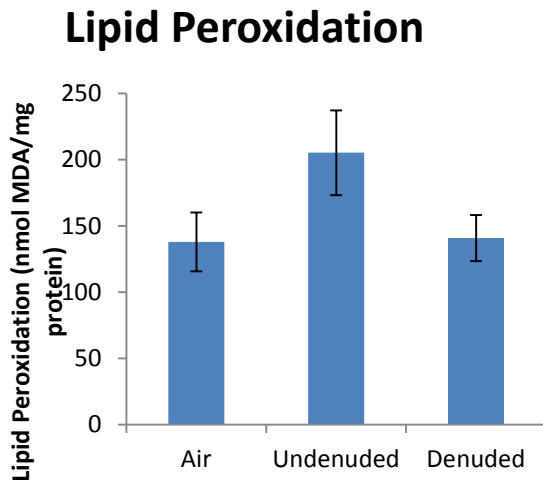


Exposure raises cholesterol but the organic fraction oxidizes the lipids promoting atherosclerosis



Air

Denuded



Undenuded

Aortic Arch 2x



# Conclusions

- The organic constituents of UFP are important contributors to atherosclerotic plaque development and significantly accelerate the growth of arterial plaques after an 8 week exposure; and
- Exposure to both organic and inorganic constituents of UFP raise serum concentrations of cholesterol and low density lipoprotein-cholesterol (LDL);
- But, exposures to UFP that were denuded of most organic constituents did not promote serum lipid peroxidation but exposures to undenuded UFP or to PFO did promote serum lipid peroxidation.
- Progressive losses in HRV were seen with CAPs but not with denuded CAPs.
- This study has demonstrated that the semi-volatile PM fraction of ambient ultrafine particulate matter is an important contributor to the development of atherosclerosis and heart disease.
- Thermal denuding technology such as afterburner emission controls not only reduce pollution but reduce the toxicity of the residual particles.

# Nanoparticles may also play a role in Brain Disease

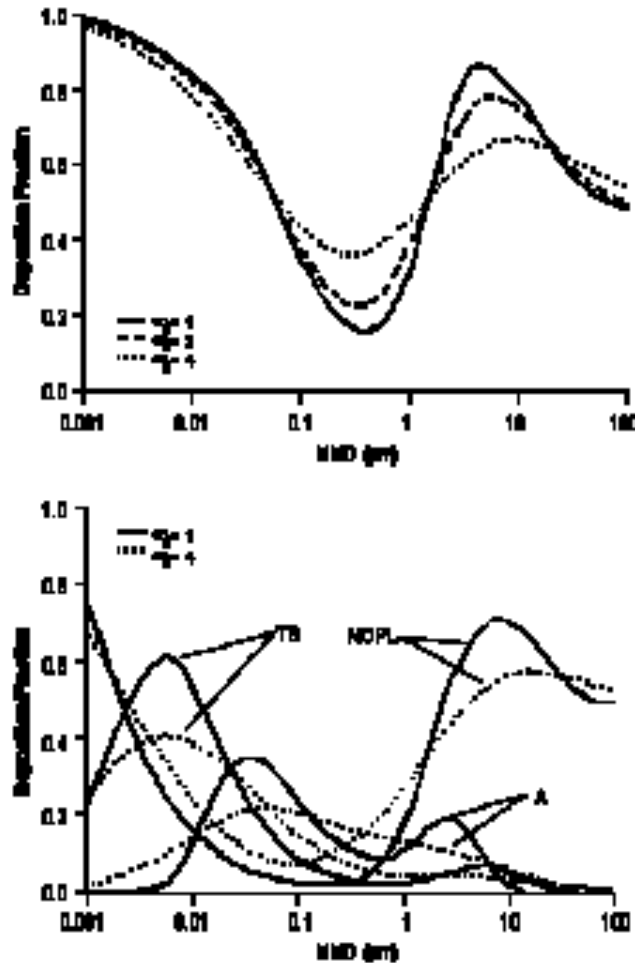
- Degenerative brain disease incidences are increasing and may be irreversible.
- There is increasing evidence for a role of environmental interactions in the rising disease rates.
- Mechanisms are elusive, at best.

# Background

- Evidence from epidemiological studies demonstrated that brains of individuals (humans and dogs) living in areas with elevated levels of ambient PM exhibited inflammation and lesions. Subsequent controlled studies have supported some of these early findings.
- Growing evidence that PM exposure increases production of inflammatory mediators and damages or kills brain cells.
- PM exposure can affect cells that are essential for the production and metabolism of the neurotransmitter dopamine.



## Ultrafine Particles are Deposited in the URT to a Great Degree

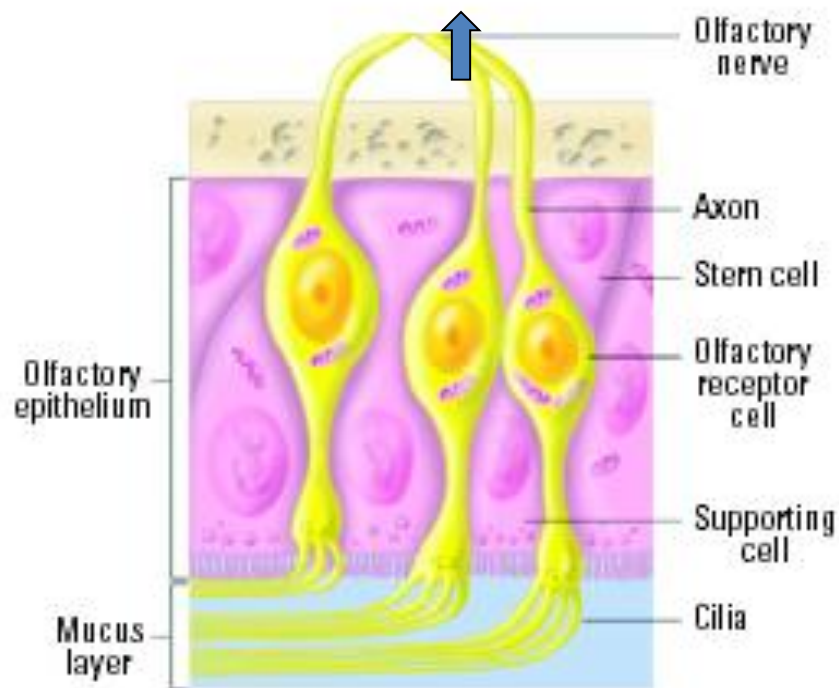


- UF Particles deposit by diffusion
- Both alveolar and nasopharyngeal regions are targeted.

Figure 5.1 Calculated mass deposition of polydisperse aerosols of unit density with various geometric standard deviations ( $\sigma_g$ ) as a function of mass median diameter (MMD) for quiet breathing (tidal volume = 750 mL, breathing frequency = 15 min<sup>-1</sup>). The upper panel is total deposition and the lower panel is regional deposition (NOPL = Naso-oro-pharyngo-laryngeal, TB = Tracheobronchial, A = Alveolar). The range of  $\sigma_g$  values demonstrates the extremes of monodisperse to extremely polydisperse. Source: Yeh et al. (1993).

Figure 2. Inhaled fine and ultrafine particles can access the brain by translocation via the blood and also by passage along nerve cells. Below is an example of transport along olfactory nerves <sup>1</sup>

## BRAIN



1. Adapted from Oberdorster et al., Environ, Health Perspect., **113:823–839**,2005.

**Figure 3. Mn uptake in brain is active.** Mn<sup>2+</sup> enhancement from bulb through posterior cortex over time. Z statistic maps of significant enhancement seen when comparing 6, 12, 24, 48, 72 h post-administration scans to pre-administration scans (six rats) and 5.5 days compared to pre-administration (three rats). Rows represent different coronal slices as a distance from bregma landmark according to [Paxinos and Watson, 1988](#)

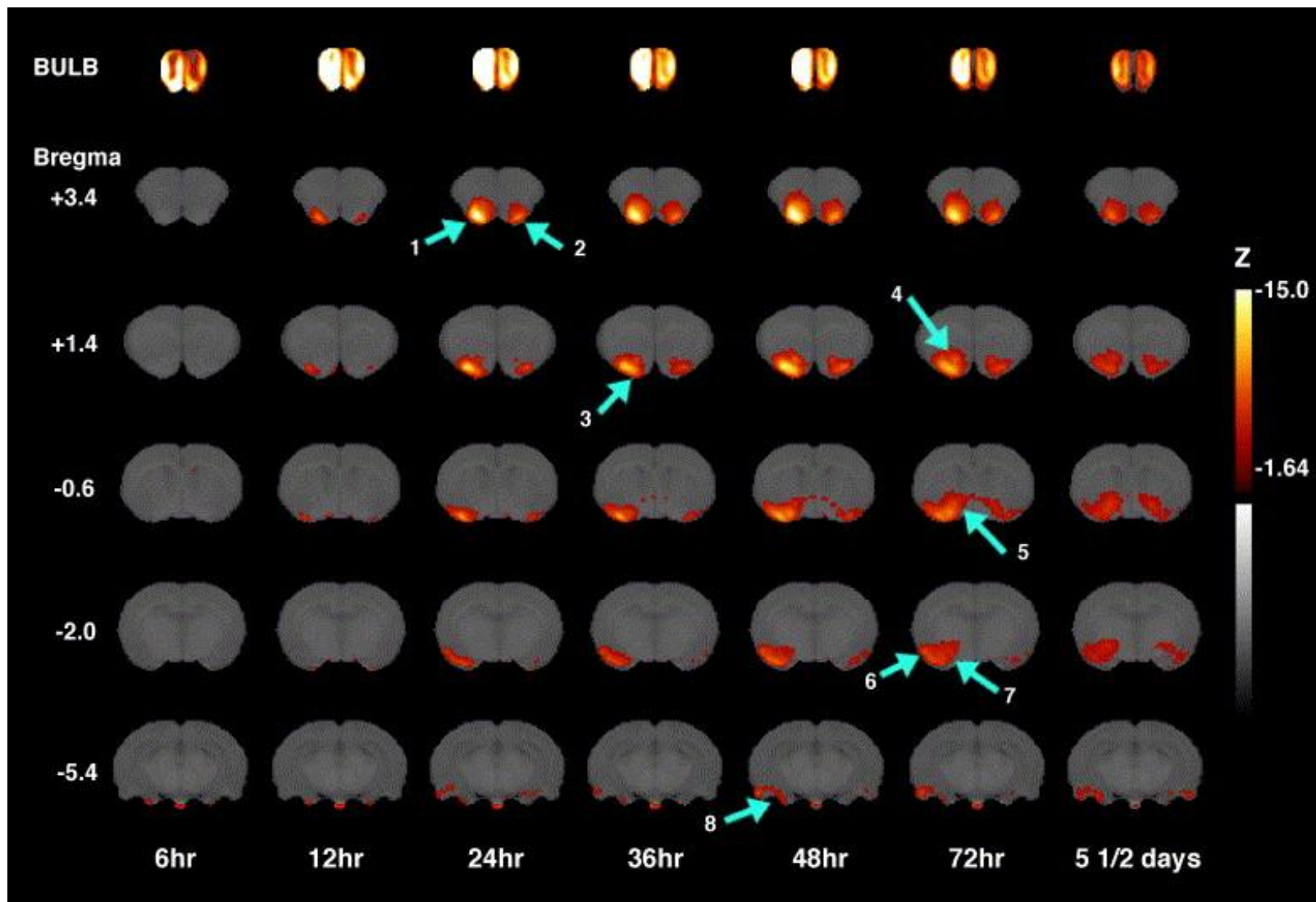
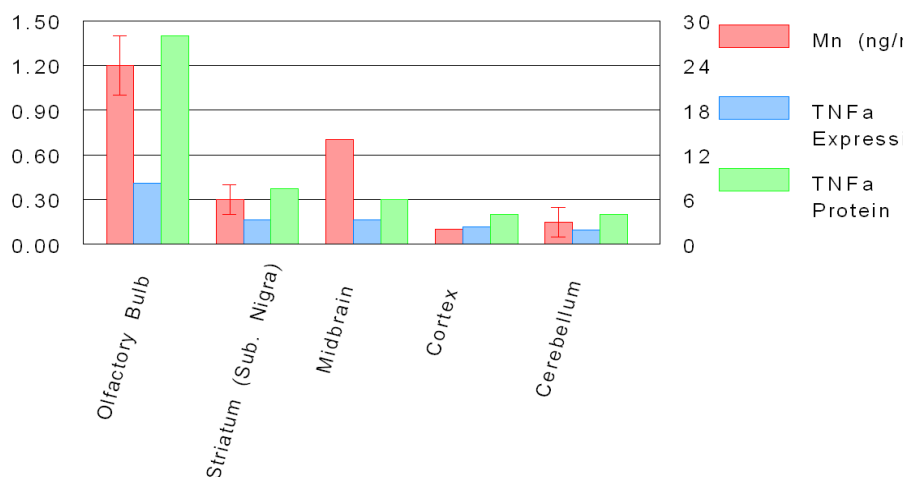
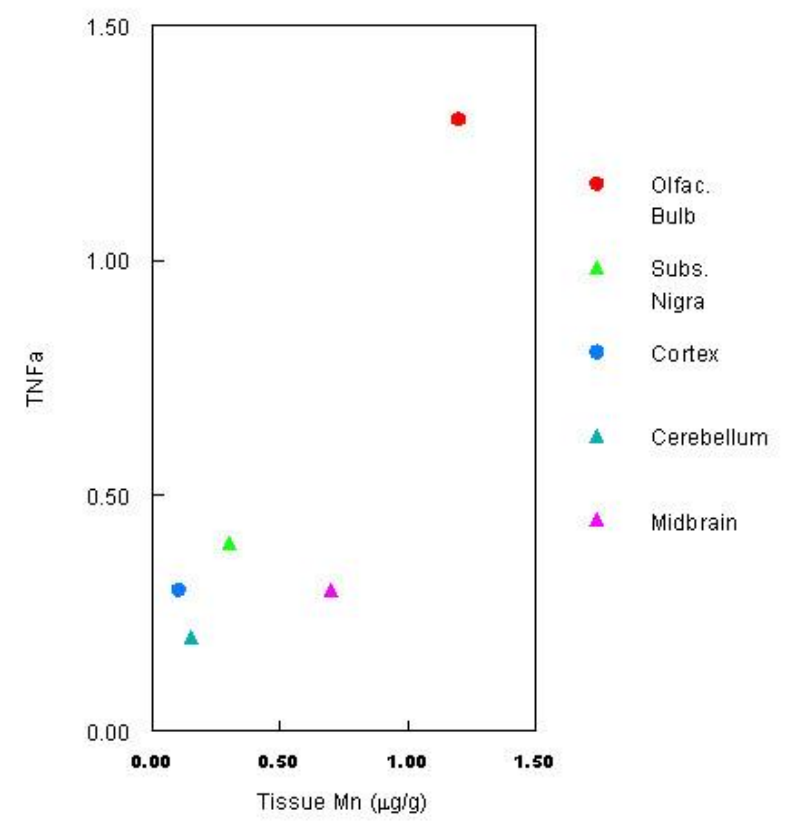


Figure 7. Transport to the brain via the olfactory pathway is possible and bypasses homeostatic controls. Mice inhaled Mn nanoparticles for 12 days. Mn accumulated in areas of the brain. The amount of TNF $\alpha$  increased proportionally with the amount of Mn in the brain region. The highest concentrations occur in the olfactory bulb, as might be expected if the inhaled particles accessed the brain via the olfactory nerve pathway. (Adapted from Elder et 2006)

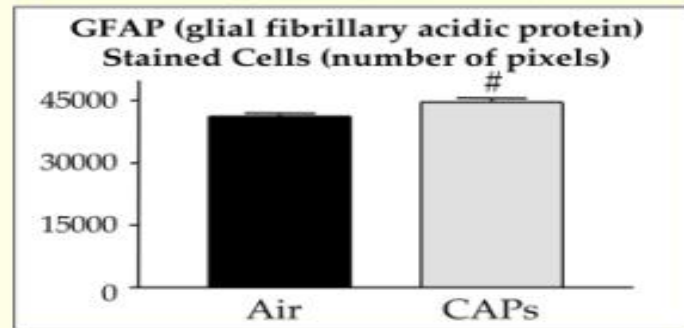
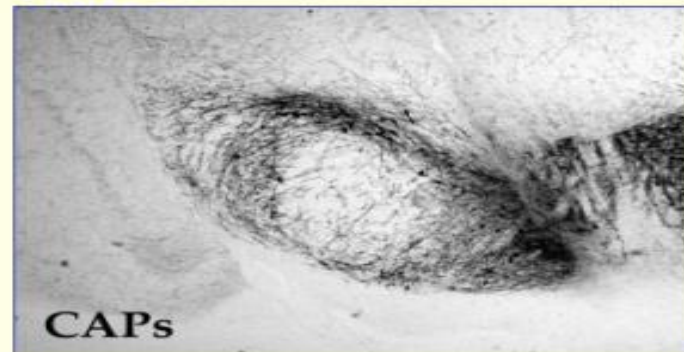
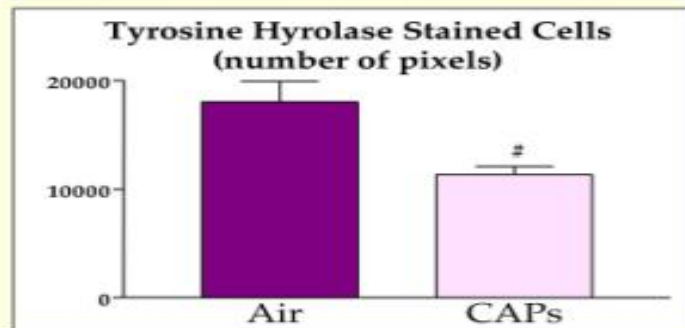
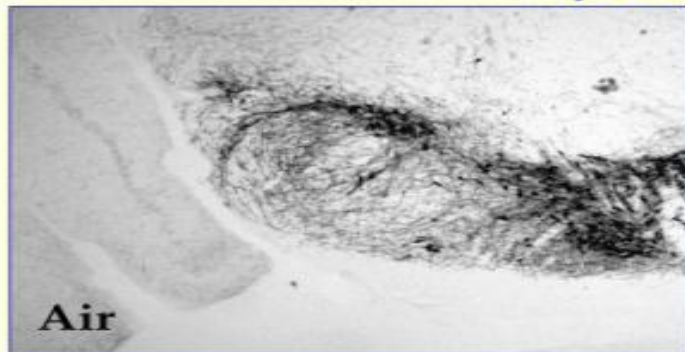


TNF $\alpha$  is Elicited by Mn in a Dose-Dependent Manner



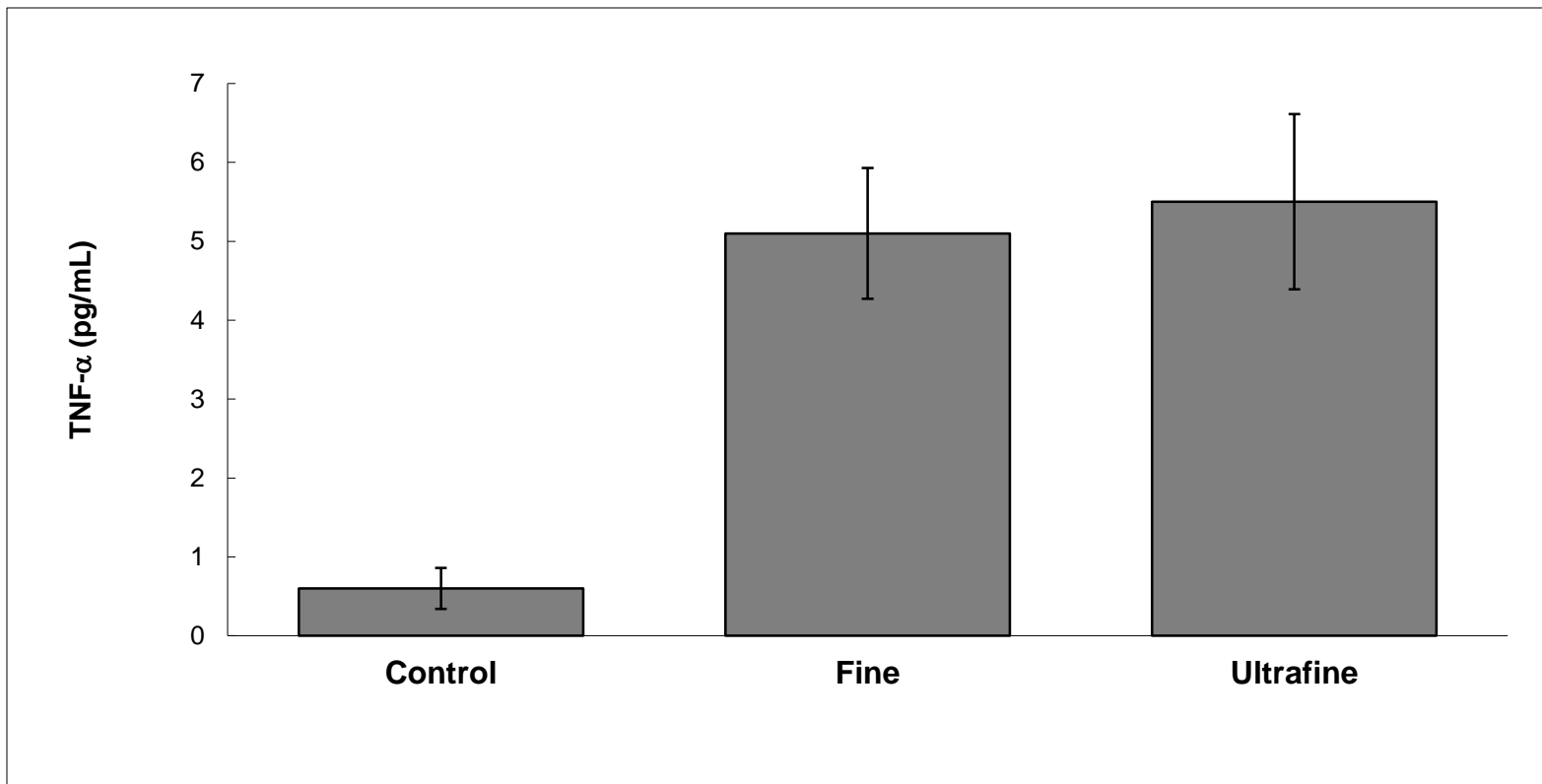
Inhalation of fine and ultrafine particles injures or kills cells in the brain that make dopamine from tyrosine hydroxylase in the region called the substantia nigra. This process may be caused by activation of immune system cells that are identified using a stain for glial fibrillary acidic protein (GFAP) <sup>2</sup>

## Effects of CAPs on substantia nigra of ApoE<sup>-/-</sup> Mice



2. Veronesi et al., Inhal Toxicol 17: 235-41; 2005.

Both fine and ultrafine particles cause inflammatory responses in the brain which can be identified by measuring increased levels of the cytokines TNF $\alpha$  in the brains of CAPs-exposed mice.



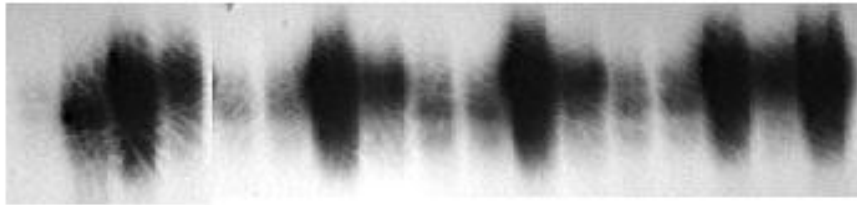
# One Possible Mechanism for Induction of Inflammation by Quasi-Ultrafine

## Particle Exposure

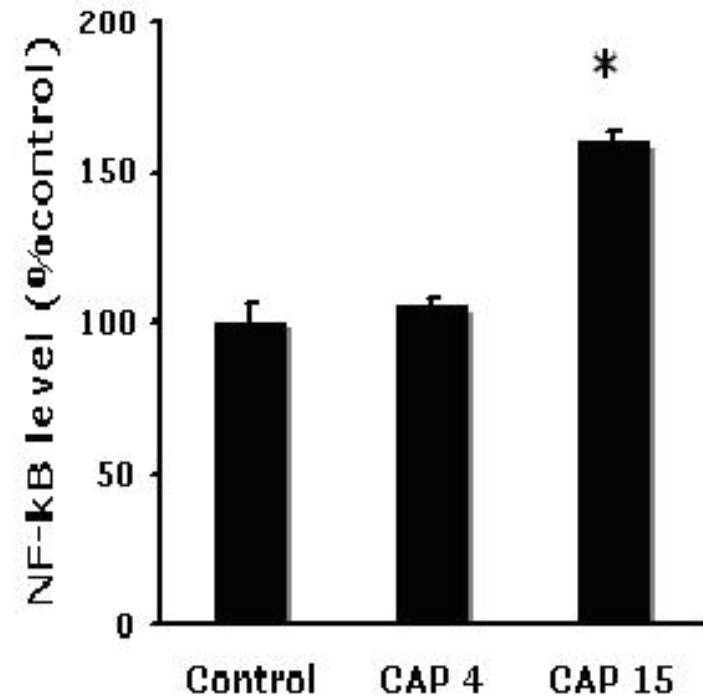
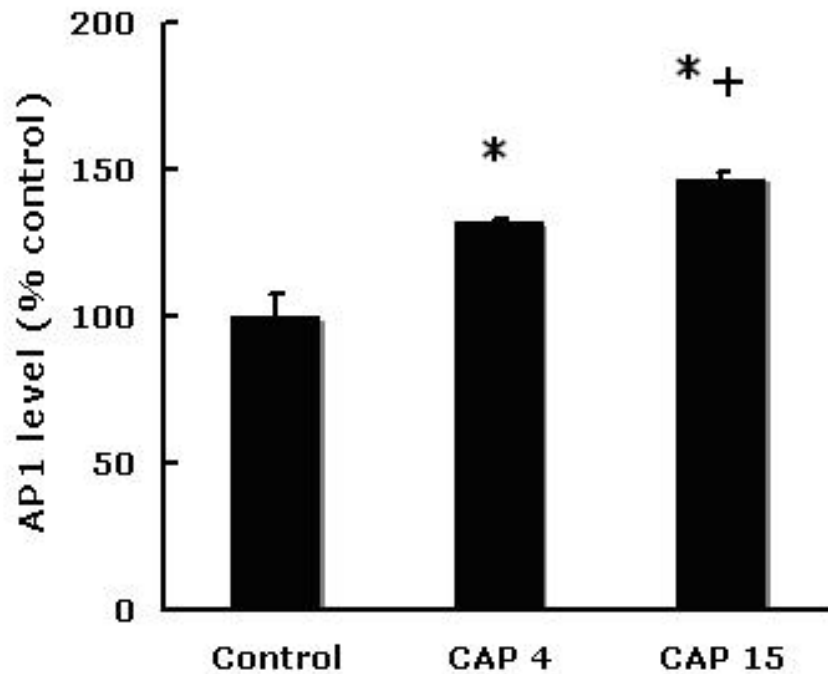
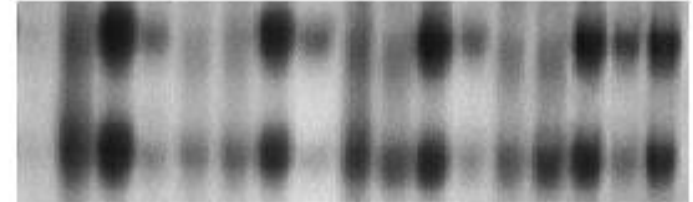
- The concentrations of two factors that control gene transcription of proteins related to inflammatory responses, Nf- $\kappa$ B and AP-1, were increased in the brains of mice by both low (CAP 4 =  $\sim 30 \mu\text{g}/\text{m}^3$ ) and high (CAP 15 =  $\sim 100 \mu\text{g}/\text{m}^3$ ) concentrations of quasi-ultrafine PM.
- There were some changes in the expression of mitogen activated protein kinases (MAPK) that regulate various transcription factors in the brain but a clear pattern has not yet emerged.
- Activated NF $\kappa$ B translocates to the cell nucleus and induces the expression of inflammatory cytokines including TNF $\alpha$  and IL-1

# Ultrafine Particle Exposure Increases Expression of AP-1 and NFkB

AP-1

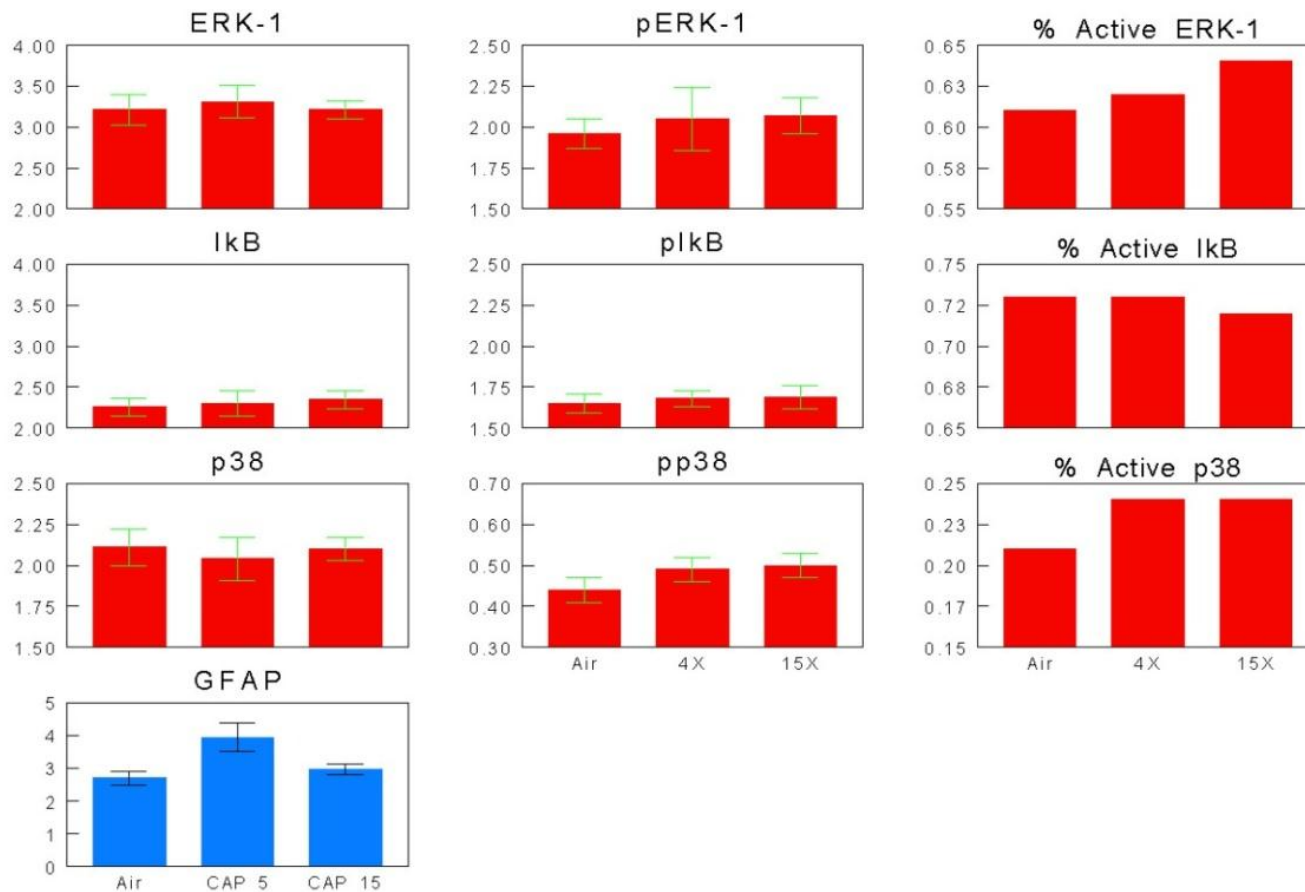


NFkB





# Induction of Inflammatory Factors may involve Activation of Astrocytes/Microglial Cells and Initiation of Mitogen Activated Protein Kinase (MAPK) Signaling



# What Do We Know?

- Inhaled ultrafine particles can travel from the nose to the brain by traveling along the olfactory nerve.
- This “backdoor” pathway bypasses the blood brain barrier which is the brain’s defensive shield that blocks unwanted chemicals from reaching sensitive brain cells.

# Where Do We Stand?

- Inhaled fine and ultrafine particles can damage brain cells in the part of the brain that we know is also injured in degenerative nerve diseases such as Parkinson's.
- In addition to damaging cells that make dopamine, inhaled ultrafine and fine particles induce biochemical pathways of inflammation in the brain and those changes can be seen weeks after the exposures were completed.

# What Does It All Mean??

- The linkage of PM-induced injury in the central nervous system may also be related to impaired control of heart and lung function (i.e HRV is controlled by the balance of sympathetic and parasympathetic nerve pathways).
- The transfer of inhaled fine and ultrafine particles into the brain raises serious concerns, for example:
  - for individuals exposed in regions with high concentrations of these particles, i.e. near heavily trafficked roads,
  - near pollutant sources and in some workplaces during the manufacture or application of numerous industrial and commercial products that contain nanomaterials.

# Conclusions and Significance

- The nuclei and accumulation mode particle compositions are different.
  - Accumulation mode contains more oxygenated organics
  - Quasi-ultrafine CAPs are composed of less oxygenated compounds including PAHs.
- Toxicity and free radical generating capacity of CAPs is greatly reduced by thermal denuding of the particles.
- CAPs exposure increases inflammatory responses in the brain and is associated with damage to dopamine producing cells in the brain.
- The effects of denuded CAPs on HRV and Arterial Plaque formation are significantly reduced suggesting that organic components can affect cardiac function and disease pathology due to toxic effects of the organics (e.g. PAHs or oxygenated hydrocarbons) or by free radicals released by organic constituents.

# Acknowledgements



- Research using the AMS and SMPS was through AirUCI and funded by the National Science Foundation.



- L.W. thanks Mike Ezell for SMPS measurements, Prof. Nizkorodov for loan of the CPC, and Dr. Veronique Perraud and Emily Bruns for helping move the AMS.



Moving the AMS is a group effort!



*California Environmental Protection Agency*

**AIR RESOURCES BOARD**



Health studies at are currently sponsored by the California Air Resources Board, the US EPA and the NIEH.S



**NIEHS**

National Institute of  
Environmental Health Sciences

# Questions and Discussion

